

# Jeremiah Lighting

## ASSEMBLY & INSTALLATION INSTRUCTIONS FOR #21703

*Please read carefully and save these instructions, as you may need them at a later date.*

### CAUTION

Turn off the main power at the circuit breaker before installing the fixture, in order to prevent possible shock.

### GENERAL

All electrical connections must be in accordance with local and National Electrical Code (N.E.C.) standards. If you are unfamiliar with proper electrical wiring connections obtain the services of a qualified electrician.

Remove the fixture and the mounting package from the box and make sure that no parts are missing by referencing the illustrations on the installation instructions.

### ASSEMBLY AND INSTALLATION

1. At the center of the BACK PLATE (2) there are eight perforated slots. Knock out the set matches your OUTLET BOX (1).
2. Screw the #8-32 FIXTURE MOUNTING SCREWS (13) into the BACK PLATE (2) and thread the #8-32 HEX NUTS (14) onto the FIXTURE MOUNTING SCREWS (13), as shown. Secure the position of the FIXTURE MOUNTING SCREWS (13) by tightening the HEX NUTS (14) against the BACK PLATE (2).
3. Carefully pass the power supply (6&8) wires and the SUPPLY GROUND WIRE (5) through the center hole of the BACK PLATE (2). Secure the BACK PLATE (2) to the OUTLET BOX (1) with MOUNTING SCREWS (3).
4. Attach the BLACK SUPPLY WIRE (8) to the SMOOTH (or BLACK) FIXTURE LEAD WIRE (9) by using the WIRE CONNECTOR (10). At the same manner, attach the WHITE SUPPLY WIRE (6) to the RIBBED (or WHITE) FIXTURE LEAD WIRE (7). Loop the FIXTURE GROUND WIRE (4) around the GROUND SCREW (11) of the BACK PLATE (2). (Note: Be sure to provide an extra 3" length of the FIXTURE GROUND WIRE (4) for connection to the SUPPLY GROUND WIRE (5).) Tighten the GROUND SCREW (11). Connect the remaining FIXTURE GROUND WIRE (4) to the SUPPLY GROUND WIRE (5) using a WIRE CONNECTOR (10). Place wiring and connections inside the OUTLET BOX (1).
5. Place the COVER PLATE (12) onto the FIXTURE MOUNTING SCREWS (13), and secure it into place using the DECORATIVE NUTS(15) provided.

### ASSEMBLY AND INSTALLATION (Continued)

6. Slide the GLASS SHADE(19) over the SOCKET(18), secure with the SOCKET RING(20). Screw the FINIAL(16) into the SQUARE BAR(17).
7. Screw light bulbs into the sockets and make sure they do not exceed the maximum wattage specified on the fixture's wattage rating label, **MAXIMUM 100W.**

INSTALLATION IS NOW COMPLETED

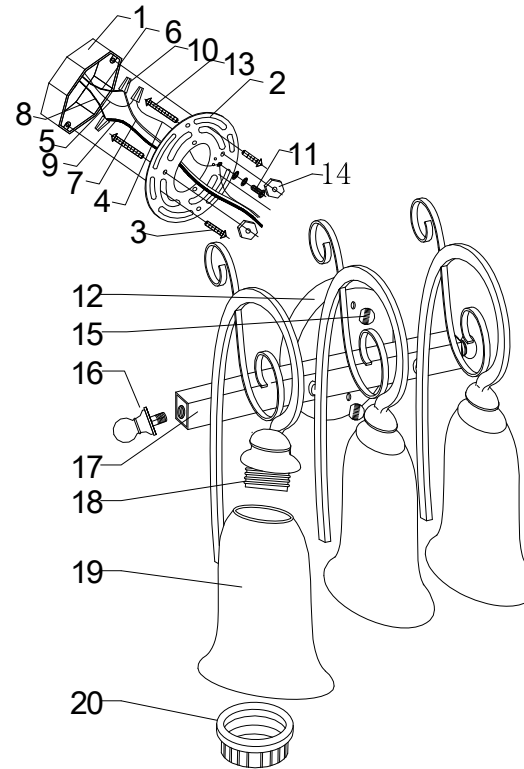

- |  |                                  |
|--|----------------------------------|
| 1. OUTLET BOX                          | 12. COVER PLATE                  |
| 2. BACK PLATE                          | 13. #8-32 FIXTURE MOUNTING SCREW |
| 3. MOUNTING SCREW                      | 14. #8-32 HEX NUT                |
| 4. FIXTURE GROUND WIRE                 | 15. DECORATIVE NUT               |
| 5. SUPPLY GROUND WIRE                  | 16. FINIAL                       |
| 6. WHITE SUPPLY WIRE                   | 17. SQUARE BAR                   |
| 7. RIBBED (OR WHITE) FIXTURE LEAD WIRE | 18. SOCKET                       |
| 8. BLACK SUPPLY WIRE                   | 19. GLASS SHADE                  |
| 9. SMOOTH (OR BLACK) FIXTURE LEAD WIRE | 20. SOCKET RING                  |
| 10. WIRE CONNECTOR                     |                                  |
| 11. GROUND SCREW                       |                                  |