



LED

6" Pro-Optic® LED Retrofit Downlight
120-277V
0-10V Dimming

Recessed



Type _____
-EB -EBSD
P8002

All Items **MTO**

LED Housing Catalog No.	Description	Lamping	Suitable Plaster Frame Aperture Range (see Notes)
P8002-EB	6" LED Retrofit Hsg.	See Trim Specifications	6-1/8" min. to 6-7/8" max.
P8002-EBSD	6" LED Retrofit Hsg. Small Diameter	See Trim Specifications	5-15/16" min. to 6-1/8" max.

Ceiling Cutout: see guide

Maximum Ceiling Thickness: 1-1/2"

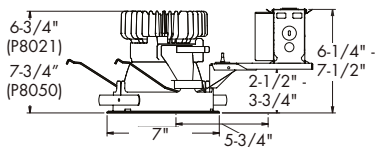
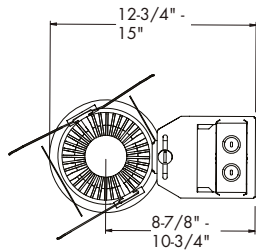

Notes:
To order proper housing:
1. Measure existing plaster frame aperture
2. Use Compatibility Guide for selecting hsg

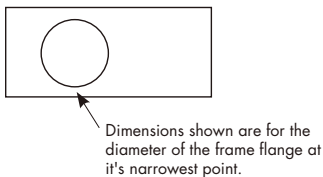

Housing Compatibility Guide		
Ordering Guidelines	6 inch	
	MIN	MAX
Requires SD Housing Option	5-15/16	6-1/8
All Standard Housings	6-1/8	6-1/2
Requires P8100-01 Ring Accessory and WF trims	6-1/2	6-7/8

Housing Accessory

P8100-01 6" Ring Accessory (Use when WF trims are required) 6-1/2" min. to 6-7/8" max.

LED Trim

Catalog No.	Reflector Finish	LED Color Temp	Flange Options
<input type="checkbox"/> P8021 6" LED, 1100lm	<input type="checkbox"/> -21A Clear Alzak®	<input type="checkbox"/> /30K 3000 Kelvin	<input type="checkbox"/> WF Wide Flange
<input type="checkbox"/> P8050 6" LED, 2000lm	<input type="checkbox"/> -22A Gold Alzak®	<input type="checkbox"/> /35K 3500 Kelvin	(White flange standard)
	<input type="checkbox"/> -28 White	<input type="checkbox"/> /40K 4000 Kelvin	

Example: P8021-21A/30KWF (Ordered separately)

Specifications:

General

- Commercial grade LED retrofit downlight combines superior brightness control with energy savings and low maintenance
- Suitable for commercial, retail or other institutional applications with ambient temperatures up to 40°C (104°F)

Housing

- Components made of quality die cast aluminum or galvaneal steel
- Installation can be performed from below the ceiling without removing the existing fixture
- Pre-wired J-box with snap on cover for easy access
- Approved for 8 (4 in/4 out) No. 12 AWG conductors rated for 90°C through wiring
- Snap in connections from driver compartment allow easy installation of LED trim assembly without tools above or below ceiling
- Standard with ballast disconnect
- Can be upgraded to accomodate technology improvements

LED Driver

- Efficient Class 2 driver specifically designed for optimal performance with Fortimo DLM module system
- 120-277VAC input, 50/60Hz
- >0.90 Power Factor

- Compliant to FCC 47CFR Part 15 Class A
- Flicker-free 0-10V Dimming to 10%
- Intergrated thermal feedback loop to ensure driver life of 50,000 hrs

LED Light Engine/Reflector

- Uses Philips Fortimo DLM 1100 lumen or 2000 lumen LED modules
- 50,000 hrs at 70% lumen maintenance
- 80 CRI in 30K, 35K or 40K CCT
- Remote phosphor LED technology utilizes high-brightness royal blue LEDs allowing phosphor lens to be exposed to less heat degradation than traditional LEDs
- Provides more controlled color consistency fixture to fixture and over life
- Energy efficient providing 50 LPW delivered from fixture
- High purity aluminum reflector in white or Alzak. Painted white flange standard.

Labeling

- cCSAus certified to US and Canadian standards
- Non-IC rated.
- Suitable for wet locations
- 5 year warranty

Progress Lighting
701 Millennium Blvd.
Greenville, South Carolina
29607

www.progresslighting.com



LED

6" Pro-Optic® LED Retrofit Downlight

Recessed

P8002/P8021/P8050

P8002 Housing with DRIVER DATA	P8021 (1100 lumen)			P8050 (2000 lumen)		
	30K	35K	40K	30K	35K	40K
Input Voltage	120-277V	120-277V	120-277V	120-277V	120-277V	120-277V
Input Frequency	50/60 Hz	50/60 Hz	50/60 Hz	50/60 Hz	50/60 Hz	50/60 Hz
Input Current	0.146A (120v) 0.063 (277v)	0.156A (120v) 0.067 (277v)	0.137A (120v) 0.059 (277v)	0.146A (120v) 0.063 (277v)	0.156A (120v) 0.067 (277v)	0.137A(120v) 0.059 (277v)
Input Power	17.3W	18.5W	16.3W	36W	34W	33W
Constant Current Output	200-700mA	200-700mA	200-700mA	200-700mA	200-700mA	200-700mA
Power Factor	≥0.90	≥0.90	≥0.90	≥0.90	≥0.90	≥0.90
THD	<20%	<20%	<20%	<20%	<20%	<20%
EMI Filtering	FCC 47CFR Part 15, Class A	FCC 47CFR Part 15, Class A	FCC 47CFR Part 15, Class A	FCC 47CFR Part 15, Class A	FCC 47CFR Part 15, Class A	FCC 47CFR Part 15, Class A
Operating Temperature	-20°C to 55°C	-20°C to 55°C	-20°C to 55°C	-20°C to 55°C	-20°C to 55°C	-20°C to 55°C
Dimming	0-10V	0-10V	0-10V	0-10V	0-10V	0-10V
Over-voltage, over-current, short-circuit protected						

Dimming 0-10V 100% to 10%

Pro-Optic LED driver is compatible with 0-10V type dimming controls. Recommended dimming controls are listed below.

Control Manufacturer	Wallbox Dimmer	Power Booster Available
Douglas Lighting controls	WPC 5721	
Entertainment Technology	Tap Glide TG600FAM120 (120V) Tap Glide Heatsink TGH1500FAM120 (120V) Oasis OA2000FAMU (120/277V)	
Honeywell, Inc.	EL 7315A1019 and EL7315A1009	EL7305A1010
HUNT Dimming	Preset Slide: PS-010-IV-120V and PS-010-WH-120V Preset Slide: PS-010-3W-IV-120V and PS-010-3W-WH-120V Preset Slide: PS-010-IV-277V and PS-010-WH-277V Preset Slide: PS-010-3W-IV-277V and PS-010-3W-WH-277V Preset Slide, controls FD-010: PS-IFC-010-IV- and PS-IFC-010-WH-120/277V Preset Slide, controls FD-010: PS-IFC-010-3W-IV- and PS-IFC-010-3W-WH-120/277V Remoted mounted unit: FD-010-120V and FD-010-277V	
Lehigh Electric Products Co.	Solitaire	PBX
Leviton Lighting Controls Div.	Leviton Centura Fluorescent Control System IllumaTech™ IP7 Series	CN100 PE300
Lightolier Controls	Sunrise Preset slider ZP600FAM120 (120V) Momentum Preset slider MP1500FAM120 (120V) Vega Slider V2000FAMU (120/277)	
Lithonia Controls	ISD BC SLD LPCS Digital Equinox (DEQ BC)	RDM FC
Lutron Electronics Co., Inc.	Visit www.lutron.com/advance for the latest control information and selection	
PDM Electrical products	WPC-5721	
Starfield Controls	TR61 with DALI interface port	RT03 DAL Inet router
The Watt Stopper, Inc.	LS4 used with LCD-101 and LCD-103	





LED

6" Pro-Optic® LED Retrofit Downlight

Recessed

P8002/P8021/P8050

P8002-EB WITH P8021-21A/30K

LED Light Engine: 3000K, 80 CRI
 System Wattage: 17.3W
 Fixture Delivered Lumens: 890
 Fixture Efficacy: 51
 Spacing Criteria: 1.2

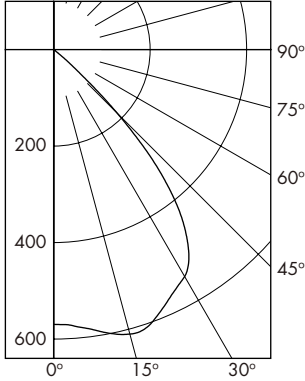

Test No. 3964

Tested at 25°C Ambient in accordance to IESNA LM-79-2008

CANDELA DISTRIBUTION

DEG	CANDELA	LUMENS
0	541	
5	548	53
15	580	164
25	540	250
35	459	283
45	177	134
55	3	5
65	0	1
75	0	0
85	0	0
90	0	0

ZONAL LUMEN SUMMARY

ZONE	LUMENS	%LUMINAIRE
0-30	466	52.4
0-40	749	84.2
0-60	889	99.9
0-90	890	100.0
90-180	0	0.0
0-180	890	100.0

LUMINANCE DATA IN CANDELA/SQ. METER

Angle in Vertical	Average - 0°
45°	14936
55°	312
65°	0
75°	0
85°	0

COEFFICIENTS OF UTILIZATION Zonal Cavity Method

Room Cavity Ratio	% Effective Floor Cavity Reflectance																
	80%			70%			50%			30%			10%				
	20% Effective Floor Cavity Reflectance																
	% Wall Reflectance																
	70	50	30	10	70	50	30	10	50	30	10	50	30	10			
1	113	110	107	105	110	108	105	103	104	102	100	100	98	97	96	95	94
2	107	101	97	93	104	99	95	92	96	93	90	93	90	88	90	88	86
3	100	93	88	83	98	92	87	82	89	85	81	87	83	80	84	81	79
4	94	86	80	75	92	85	79	74	82	77	74	80	76	73	78	75	72
5	89	79	73	68	87	78	72	67	76	71	67	75	70	66	73	69	66
6	83	73	66	62	82	72	66	61	71	65	61	69	64	61	68	64	60
7	78	68	61	56	77	67	61	56	66	60	56	64	59	55	63	59	55
8	74	63	56	52	72	62	56	51	61	55	51	60	55	51	59	54	51
9	69	59	52	47	68	58	52	47	57	51	47	56	51	47	55	50	47
10	66	55	48	44	64	54	48	44	53	48	44	52	47	43	52	47	43

P8002-EB WITH P8021-21A/35K

LED Light Engine: 3500K, 80 CRI
 System Wattage: 18.5W
 Fixture Delivered Lumens: 916
 Fixture Efficacy: 50
 Spacing Criteria: 1.2

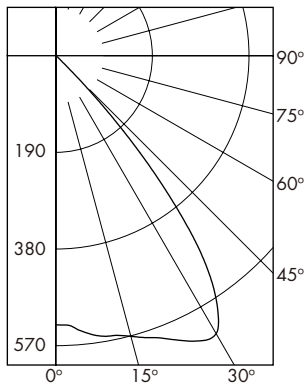

Test No. 3853

Tested at 25°C Ambient in accordance to IESNA LM-79-2008

CANDELA DISTRIBUTION

DEG	CANDELA	LUMENS
0	573	
5	584	56
15	606	170
25	562	259
35	469	289
45	179	136
55	3	4
65	1	1
75	0	0
85	0	0
90	0	0

ZONAL LUMEN SUMMARY

ZONE	LUMENS	%LUMINAIRE
0-30	486	53.0
0-40	775	84.6
0-60	915	99.9
0-90	916	100.0
90-180	0	0.0
0-180	916	100.0

LUMINANCE DATA IN CANDELA/SQ. METER

Angle in Vertical	Average - 0°
45°	15105
55°	312
65°	141
75°	0
85°	0

COEFFICIENTS OF UTILIZATION Zonal Cavity Method

Room Cavity Ratio	% Effective Floor Cavity Reflectance																
	80%			70%			50%			30%			10%				
	20% Effective Floor Cavity Reflectance																
	% Wall Reflectance																
	70	50	30	10	70	50	30	10	50	30	10	50	30	10			
1	113	110	107	105	110	108	105	103	104	102	100	100	98	97	97	95	94
2	107	101	97	93	104	99	95	92	96	93	90	93	90	88	90	88	86
3	100	93	88	83	98	92	87	83	89	85	81	87	83	80	84	81	79
4	94	86	80	75	92	85	79	75	83	78	74	80	76	73	79	75	72
5	89	79	73	68	87	78	72	68	77	71	67	75	70	66	73	69	66
6	83	73	67	62	82	73	66	62	71	65	61	70	65	61	68	64	60
7	78	68	61	57	77	67	61	56	66	60	56	65	60	56	64	59	55
8	74	63	56	52	73	63	56	52	61	56	51	60	55	51	59	55	51
9	70	59	52	48	68	58	52	48	57	52	47	56	51	47	55	51	47
10	66	55	48	44	65	54	48	44	54	48	44	53	47	44	52	47	44





LED

6" Pro-Optic® LED Retrofit Downlight

Recessed

P8002/P8021/P8050

P8002 WITH P8021-21A/40K

LED Light Engine: 4000K, 80 CRI
 System Wattage: 16.3W
 Fixture Delivered Lumens: 911
 Fixture Efficacy: 55
 Spacing Criteria: 1.2

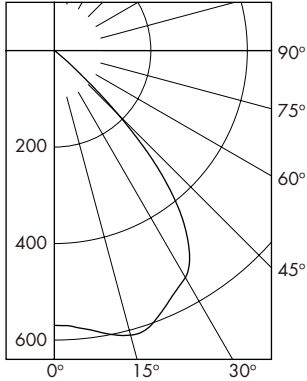

CANDELA DISTRIBUTION

DEG	CANDELA	LUMENS
0	569	
5	580	56
15	602	169
25	560	258
35	467	288
45	178	135
55	3	4
65	1	0
75	0	0
85	0	0
90	0	0

Test No. 3969

Tested at 25°C Ambient in accordance to IESNA LM-79-2008

ZONAL LUMEN SUMMARY

ZONE	LUMENS	%LUMINAIRE
0-30	483	53.0
0-40	771	84.6
0-60	911	99.9
0-90	911	100.0
90-180	0	0.0
0-180	911	100.0

LUMINANCE DATA IN CANDELA/SQ. METER

Angle in Vertical	Average -
45°	15021
55°	312
65°	141
75°	0
85°	0

COEFFICIENTS OF UTILIZATION Zonal Cavity Method

Room Cavity Ratio	% Effective Floor Cavity Reflectance																
	80%			70%			50%			30%			10%				
	20% Effective Floor Cavity Reflectance																
	% Wall Reflectance																
	70	50	30	10	70	50	30	10	50	30	10	50	30	10			
1	113	110	107	105	110	108	105	103	104	102	100	100	98	97	97	95	94
2	107	101	97	93	104	100	95	92	96	93	90	93	90	88	90	88	86
3	100	93	88	83	98	92	87	83	89	85	81	87	83	80	84	81	79
4	94	86	80	75	93	85	79	75	83	78	74	81	76	73	79	75	72
5	89	79	73	68	87	78	72	68	77	71	67	75	70	67	73	69	66
6	83	73	67	62	82	73	66	62	71	65	61	70	65	61	68	64	60
7	78	68	61	57	77	67	61	56	66	60	56	65	60	56	64	59	55
8	74	63	57	52	73	63	56	52	61	56	52	60	55	51	59	55	51
9	70	59	52	48	68	58	52	48	57	52	48	56	51	47	55	51	47
10	66	55	48	44	65	54	48	44	54	48	44	53	48	44	52	47	44

P8002 WITH P8050-21A/35K

LED Light Engine: 3500K, 80 CRI
 System Wattage: 32.4W
 Fixture Delivered Lumens: 1656
 Fixture Efficacy: 50
 Spacing Criteria: 1.2

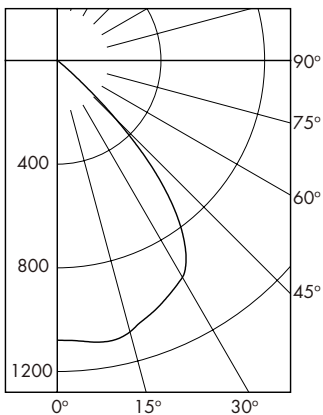

CANDELA DISTRIBUTION

DEG	CANDELA	LUMENS
0	1079	
5	1087	104
15	1084	305
25	1006	465
35	855	526
45	322	246
55	6	8
65	2	1
75	0	1
85	0	0
90	0	0

Test No. 3970

Tested at 25°C Ambient in accordance to IESNA LM-79-2008

ZONAL LUMEN SUMMARY

ZONE	LUMENS	%LUMINAIRE
0-30	874	52.8
0-40	1401	84.6
0-60	1654	99.9
0-90	1656	100.0
90-180	0	0.0
0-180	1656	100.0

LUMINANCE DATA IN CANDELA/SQ. METER

Angle in Vertical	Average - 0°
45°	24955
55°	573
65°	259
75°	0
85°	0

COEFFICIENTS OF UTILIZATION Zonal Cavity Method

Room Cavity Ratio	% Effective Floor Cavity Reflectance																
	80%			70%			50%			30%			10%				
	20% Effective Floor Cavity Reflectance																
	% Wall Reflectance																
	70	50	30	10	70	50	30	10	50	30	10	50	30	10			
1	113	110	107	105	110	108	105	103	104	102	100	100	98	97	96	95	94
2	107	101	97	93	104	99	95	92	96	93	90	93	90	88	90	88	86
3	100	93	88	83	98	92	87	83	89	85	81	87	83	80	84	81	79
4	94	86	80	75	92	85	79	75	83	78	74	80	76	73	79	75	72
5	89	79	73	68	87	78	72	68	76	71	67	75	70	66	73	69	66
6	83	73	67	62	82	73	66	62	71	65	61	70	65	61	68	64	60
7	78	68	61	57	77	67	61	56	66	60	56	65	60	56	64	59	55
8	74	63	56	52	73	63	56	52	61	56	51	60	55	51	59	55	51
9	70	59	52	48	68	58	52	48	57	51	47	56	51	47	55	51	47
10	66	55	48	44	65	54	48	44	54	48	44	53	48	44	52	47	44





LED

6" Pro-Optic® LED

Recessed

New Construction Downlight

120-277V

0-10V Dimming

Type _____

-EB

All Items **MTO**

P8023

Ceiling Cutout: see guide

Maximum Ceiling Thickness: 1-1/2"

LED Housing

Catalog No.	Description	Options
P8023-EB	6" LED New Construction Housing	* <input type="checkbox"/> EM Emergency Backup * ETO only consult factory

LED Trim

Catalog No.	Reflector Finish	LED Color Temp	Options
<input type="checkbox"/> P8021 6" LED, 1100lm	<input type="checkbox"/> -21A Clear Alzak®	<input type="checkbox"/> /30K 3000 Kelvin	<input type="checkbox"/> EM *
<input type="checkbox"/> P8050 6" LED, 2000lm	<input type="checkbox"/> -22A Gold Alzak®	<input type="checkbox"/> /35K 3500 Kelvin	* ETO only consult factory
	<input type="checkbox"/> -28 White	<input type="checkbox"/> /40K 4000 Kelvin	

(White flange standard)

Example: P8021-21A/30K (Ordered separately)

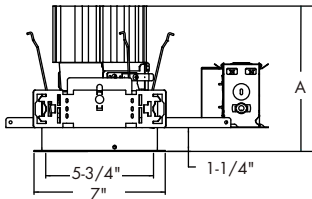
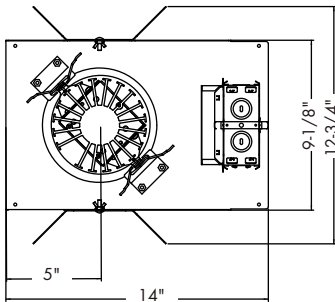

Trim	A
P8021	6-3/4"
P8050	7-3/4"

Specifications:

General

- Commercial grade LED downlight combines superior brightness control with energy savings and low maintenance
- Suitable for commercial, retail or other institutional applications with ambient temperatures up to 40°C (104°F)

Housing

- One piece 22 gauge non-corrosive steel platform
- Light commercial bar hangers included. Universal adjustable mounting brackets also accept 1/2" EMT or lathing channel (by others)
- Pre-wired J-box with snap on cover for easy access
- Approved for 8 (4 in/4 out) No. 12 AWG conductors rated for 90°C through wiring
- Snap in connections from driver compartment allow easy installation of LED trim assembly without tools above or below ceiling
- Standard with ballast disconnect
- Can be upgraded to accommodate technology improvements

LED Driver

- Efficient Class 2 driver specifically designed for optimal performance with Fortimo DLM module system
- 120-277VAC input, 50/60Hz

- >0.90 Power Factor
- Compliant to FCC 47CFR Part 15 Class A
- Flicker-free 0-10V Dimming to 10%
- Intergrated thermal feedback loop to ensure driver life of 50,000 hrs

LED Light Engine/Reflector

- Uses Philips Fortimo DLM 1100 lumen or 2000 lumen LED modules
- 50,000 hrs at 70% lumen maintenance
- 80 CRI in 30K, 35K or 40K CCT
- Remote phosphor LED technology utilizes high-brightness royal blue LEDs allowing phosphor lens to be exposed to less heat degradation than traditional LEDs
- Provides more controlled color consistency fixture to fixture and over life
- Energy efficient providing 50 LPW delivered from fixture
- High purity aluminum reflector in white or Alzak. Painted white flange standard.

Labeling

- cCSAus certified to US and Canadian standards
- Non-IC rated.
- Suitable for wet locations
- 5 year warranty

Progress Lighting
701 Millennium Blvd.
Greenville, South Carolina
29607

www.progresslighting.com



LED

6" Pro-Optic® LED

Recessed

New Construction Downlight

P8023/P8021/P8050

P8023 Housing with DRIVER DATA	P8021 (1100 lumen)			P8050 (2000 lumen)		
	30K	35K	40K	30K	35K	40K
Input Voltage	120-277V	120-277V	120-277V	120-277V	120-277V	120-277V
Input Frequency	50/60 Hz	50/60 Hz	50/60 Hz	50/60 Hz	50/60 Hz	50/60 Hz
Input Current	0.146A (120v) 0.063 (277v)	0.156A (120v) 0.067 (277v)	0.137A (120v) 0.059 (277v)	0.146A (120v) 0.063 (277v)	0.156A (120v) 0.067 (277v)	0.137A(120v) 0.059 (277v)
Input Power	17.3W	18.5W	16.3W	36W	34W	33W
Constant Current Output	200-700mA	200-700mA	200-700mA	200-700mA	200-700mA	200-700mA
Power Factor	≥0.90	≥0.90	≥0.90	≥0.90	≥0.90	≥0.90
THD	<20%	<20%	<20%	<20%	<20%	<20%
EMI Filtering	FCC 47CFR Part 15, Class A	FCC 47CFR Part 15, Class A	FCC 47CFR Part 15, Class A	FCC 47CFR Part 15, Class A	FCC 47CFR Part 15, Class A	FCC 47CFR Part 15, Class A
Operating Temperature	-20°C to 55°C	-20°C to 55°C	-20°C to 55°C	-20°C to 55°C	-20°C to 55°C	-20°C to 55°C
Dimming	0-10V	0-10V	0-10V	0-10V	0-10V	0-10V

Over-voltage, over-current, short-circuit protected

Dimming 0-10V 100% to 10%

Pro-Optic LED driver is compatible with 0-10V type dimming controls. Recommended dimming controls are listed below.

Control Manufacturer	Wallbox Dimmer	Power Booster Available
Douglas Lighting controls	WPC 5721	
Entertainment Technology	Tap Glide TG600FAM120 (120V) Tap Glide Heatsink TGH1500FAM120 (120V) Oasis OA2000FAMU (120/277V)	
Honeywell, Inc.	EL 7315A1019 and EL7315A1009	EL7305A1010
HUNT Dimming	Preset Slide: PS-010-IV-120V and PS-010-WH-120V Preset Slide: PS-010-3W-IV-120V and PS-010-3W-WH-120V Preset Slide: PS-010-IV-277V and PS-010-WH-277V Preset Slide: PS-010-3W-IV-277V and PS-010-3W-WH-277V Preset Slide, controls FD-010: PS-IFC-010-IV- and PS-IFC-010-WH-120/277V Preset Slide, controls FD-010: PS-IFC-010-3W-IV- and PS-IFC-010-3W-WH-120/277V Remoted mounted unit: FD-010-120V and FD-010-277V	
Lehigh Electric Products Co.	Solitaire	PBX
Leviton Lighting Controls Div.	Leviton Centura Fluorescent Control System IllumaTech™ IP7 Series	CN100 PE300
Lightolier Controls	Sunrise Preset slider ZP600FAM120 (120V) Momentum Preset slider MP1500FAM120 (120V) Vega Slider V2000FAMU (120/277)	
Lithonia Controls	ISD BC SLD LPCS Digital Equinox (DEQ BC)	RDM FC
Lutron Electronics Co., Inc.	Visit www.lutron.com/advance for the latest control information and selection	
PDM Electrical products	WPC-5721	
Starfield Controls	TR61 with DALI interface port	RT03 DAL Inet router
The Watt Stopper, Inc.	LS4 used with LCD-101 and LCD-103	





LED

6" Pro-Optic® LED

Recessed

New Construction Downlight

P8023/P8021/P8050

P8023-EB WITH P8021-21A/30K

LED Light Engine: 3000K, 80 CRI
 System Wattage: 17.3W
 Fixture Delivered Lumens: 890
 Fixture Efficacy: 51
 Spacing Criteria: 1.2

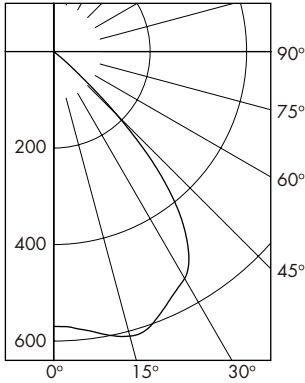

CANDELA DISTRIBUTION			
DEG	CANDELA	LUMENS	
0	541		
5	548	53	
15	580	164	
25	540	250	
35	459	283	
45	177	134	
55	3	5	
65	0	1	
75	0	0	
85	0	0	
90	0	0	

Test No. 3965

Tested at 25°C Ambient in accordance to IESNA LM-79-2008

ZONAL LUMEN SUMMARY

ZONE	LUMENS	%LUMINAIRE
0-30	466	52.4
0-40	749	84.2
0-60	889	99.9
0-90	890	100.0
90-180	0	0.0
0-180	890	100.0

LUMINANCE DATA IN CANDELA/SQ. METER

Angle in Vertical	Average - 0°
45°	14936
55°	312
65°	0
75°	0
85°	0

COEFFICIENTS OF UTILIZATION Zonal Cavity Method

Room Cavity Ratio	% Effective Floor Cavity Reflectance																			
	80%				70%				50%				30%				10%			
	20% Effective Floor Cavity Reflectance																			
	% Wall Reflectance																			
	70	50	30	10	70	50	30	10	50	30	10	50	30	10	50	30	10			
1	113	110	107	105	110	108	105	103	104	102	100	100	98	97	96	95	94			
2	107	101	97	93	104	99	95	92	96	93	90	93	90	88	90	88	86			
3	100	93	88	83	98	92	87	82	89	85	81	87	83	80	84	81	79			
4	94	86	80	75	92	85	79	74	82	77	74	80	76	73	78	75	72			
5	89	79	73	68	87	78	72	67	76	71	67	75	70	66	73	69	66			
6	83	73	66	62	82	72	66	61	71	65	61	69	64	61	68	64	60			
7	78	68	61	56	77	67	61	56	66	60	56	64	59	55	63	59	55			
8	74	63	56	52	72	62	56	51	61	55	51	60	55	51	59	54	51			
9	69	59	52	47	68	58	52	47	57	51	47	56	51	47	55	50	47			
10	66	55	48	44	64	54	48	44	53	48	44	52	47	43	52	47	43			

P8023-EB WITH P8021-21A/35K

LED Light Engine: 3500K, 80 CRI
 System Wattage: 18.5W
 Fixture Delivered Lumens: 916
 Fixture Efficacy: 50
 Spacing Criteria: 1.2

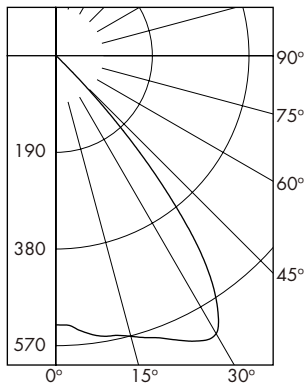

CANDELA DISTRIBUTION			
DEG	CANDELA	LUMENS	
0	573		
5	584	56	
15	606	170	
25	562	259	
35	469	289	
45	179	136	
55	3	4	
65	1	1	
75	0	0	
85	0	0	
90	0	0	

Test No. 3966

Tested at 25°C Ambient in accordance to IESNA LM-79-2008

ZONAL LUMEN SUMMARY

ZONE	LUMENS	%LUMINAIRE
0-30	486	53.0
0-40	775	84.6
0-60	915	99.9
0-90	916	100.0
90-180	0	0.0
0-180	916	100.0

LUMINANCE DATA IN CANDELA/SQ. METER

Angle in Vertical	Average - 0°
45°	15105
55°	312
65°	141
75°	0
85°	0

COEFFICIENTS OF UTILIZATION Zonal Cavity Method

Room Cavity Ratio	% Effective Floor Cavity Reflectance																			
	80%				70%				50%				30%				10%			
	20% Effective Floor Cavity Reflectance																			
	% Wall Reflectance																			
	70	50	30	10	70	50	30	10	50	30	10	50	30	10	50	30	10			
1	113	110	107	105	110	108	105	103	104	102	100	100	98	97	97	95	94			
2	107	101	97	93	104	99	95	92	96	93	90	93	90	88	90	88	86			
3	100	93	88	83	98	92	87	83	89	85	81	87	83	80	84	81	79			
4	94	86	80	75	92	85	79	75	83	78	74	80	76	73	79	75	72			
5	89	79	73	68	87	78	72	68	77	71	67	75	70	66	73	69	66			
6	83	73	67	62	82	73	67	62	71	65	61	70	65	61	68	64	60			
7	78	68	61	57	77	67	61	56	66	60	56	65	60	56	64	59	55			
8	74	63	56	52	73	63	56	52	61	55	51	60	55	51	59	55	51			
9	70	59	52	48	68	58	52	48	57	52	47	56	51	47	55	51	47			
10	66	55	48	44	65	54	48	44	54	48	44	53	47	44	52	47	44			





LED

6" Pro-Optic® LED

Recessed

New Construction Downlight

P8023/P8021/P8050

P8023 WITH P8021-21A/40K
 LED Light Engine: 4000K, 80 CRI
 System Wattage: 16.3W
 Fixture Delivered Lumens: 911
 Fixture Efficacy: 55
 Spacing Criteria: 1.2

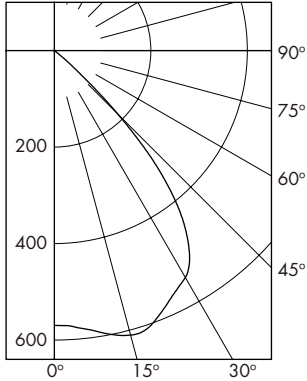

CANDELA DISTRIBUTION			
DEG	CANDELA	LUMENS	
0	569		
5	580	56	
15	602	169	
25	560	258	
35	467	288	
45	178	135	
55	3	4	
65	1	0	
75	0	0	
85	0	0	
90	0	0	

Test No. 3967

Tested at 25°C Ambient in accordance to IESNA LM-79-2008

ZONAL LUMEN SUMMARY		
ZONE	LUMENS	%LUMINAIRE
0-30	483	53.0
0-40	771	84.6
0-60	911	99.9
0-90	911	100.0
90-180	0	0.0
0-180	911	100.0

LUMINANCE DATA IN CANDELA/SQ. METER	
Angle in Vertical	Average - 0°
45°	15021
55°	312
65°	141
75°	0
85°	0

COEFFICIENTS OF UTILIZATION Zonal Cavity Method

Room Cavity Ratio	% Effective Floor Cavity Reflectance																
	80%			70%			50%			30%			10%				
	20% Effective Floor Cavity Reflectance																
	% Wall Reflectance																
	70	50	30	10	70	50	30	10	50	30	10	50	30	10			
1	113	110	107	105	110	108	105	103	104	102	100	100	98	97	97	95	94
2	107	101	97	93	104	100	95	92	96	93	90	93	90	88	90	88	86
3	100	93	88	83	98	92	87	83	89	85	81	87	83	80	84	81	79
4	94	86	80	75	93	85	79	75	83	78	74	81	76	73	79	75	72
5	89	79	73	68	87	78	72	68	77	71	67	75	70	67	73	69	66
6	83	73	67	62	82	73	66	62	71	65	61	70	65	61	68	64	60
7	78	68	61	57	77	67	61	56	66	60	56	65	60	56	64	59	55
8	74	63	57	52	73	63	56	52	61	56	52	60	55	51	59	55	51
9	70	59	52	48	68	58	52	48	57	52	48	56	51	47	55	51	47
10	66	55	48	44	65	54	48	44	54	48	44	53	48	44	52	47	44

P8023 WITH P8050-21A/35K
 LED Light Engine: 3500K, 80 CRI
 System Wattage: 32.4W
 Fixture Delivered Lumens: 1656
 Fixture Efficacy: 50
 Spacing Criteria: 1.2

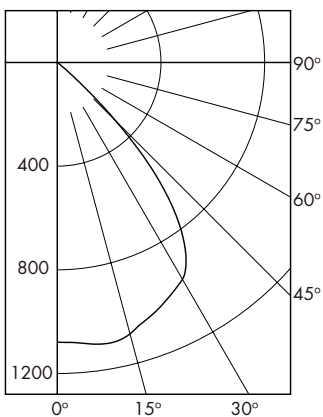

CANDELA DISTRIBUTION			
DEG	CANDELA	LUMENS	
0	1079		
5	1087	104	
15	1084	305	
25	1006	465	
35	855	526	
45	322	246	
55	6	8	
65	2	1	
75	0	1	
85	0	0	
90	0	0	

Test No. 3968

Tested at 25°C Ambient in accordance to IESNA LM-79-2008

ZONAL LUMEN SUMMARY		
ZONE	LUMENS	%LUMINAIRE
0-30	874	52.8
0-40	1401	84.6
0-60	1654	99.9
0-90	1656	100.0
90-180	0	0.0
0-180	1656	100.0

LUMINANCE DATA IN CANDELA/SQ. METER	
Angle in Vertical	Average - 0°
45°	24955
55°	573
65°	259
75°	0
85°	0

COEFFICIENTS OF UTILIZATION Zonal Cavity Method

Room Cavity Ratio	% Effective Floor Cavity Reflectance																
	80%			70%			50%			30%			10%				
	20% Effective Floor Cavity Reflectance																
	% Wall Reflectance																
	70	50	30	10	70	50	30	10	50	30	10	50	30	10			
1	113	110	107	105	110	108	105	103	104	102	100	100	98	97	96	95	94
2	107	101	97	93	104	99	95	92	96	93	90	93	90	88	90	88	86
3	100	93	88	83	98	92	87	83	89	85	81	87	83	80	84	81	79
4	94	86	80	75	92	85	79	75	83	78	74	80	76	73	79	75	72
5	89	79	73	68	87	78	72	68	76	71	67	75	70	66	73	69	66
6	83	73	67	62	82	73	66	62	71	65	61	70	65	61	68	64	60
7	78	68	61	57	77	67	61	56	66	60	56	65	60	56	64	59	55
8	74	63	56	52	73	63	56	52	61	56	51	60	55	51	59	55	51
9	70	59	52	48	68	58	52	48	57	51	47	56	51	47	55	51	47
10	66	55	48	44	65	54	48	44	54	48	44	53	48	44	52	47	44

