

# INSTALLATION AND SAFETY INSTRUCTIONS

## FOR YOUR SAFETY

**WARNING: BE SURE THE ELECTRICITY TO THE WIRES YOU ARE WORKING ON IS SHUT OFF; EITHER THE FUSE IS REMOVED OR THE CIRCUIT BREAKER IS SHUT OFF.**

## GENERAL

You don't need special tools to install this fixture. Be sure to follow the steps in the order given. Under no circumstances should a fixture be hung on house electrical wires, nor should a swag type fixture be installed on a ceiling which contains a radiant type heating system. Read instructions carefully. **If you are unclear as to how to proceed, consult a qualified electrician.**

## ASSEMBLY

Carefully remove the fixture from the carton and check that all parts are included, as shown in Figures 1 & 2. Be careful not to misplace any of the screws or parts which are needed to install this fixture.

### FIGURE 1 FOR STEM MOUNT

\*NOT SUPPLIED

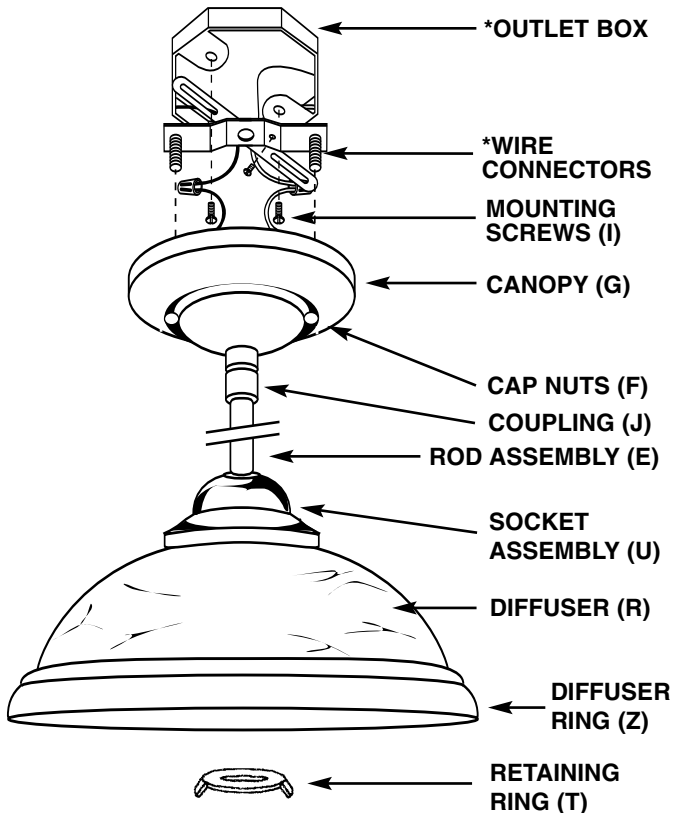

**Note: This fixture can be hung using 1, 2, or 3 rods. Select the number of rods desired.**

## FOR STEM MOUNT

### STEP 1:

Secure rods together (if applicable).

### STEP 2:

Feed the fixture wire from the socket assembly (U), through: the rod assembly (E), and coupling (J) (mounted on canopy (G)).

### STEP 3:

Secure rod assembly (E) to coupling (J), and socket assembly (U). Be sure not to damage the fixture wire.

## GROUNDING AND MOUNTING BAR LOCK UP

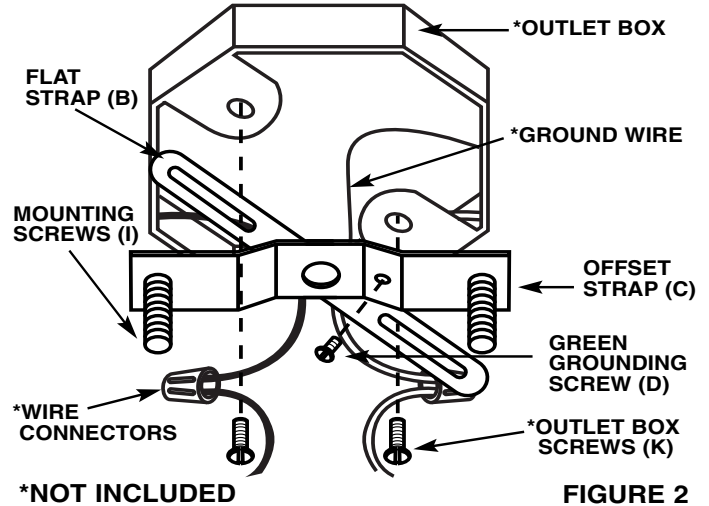

FIGURE 2

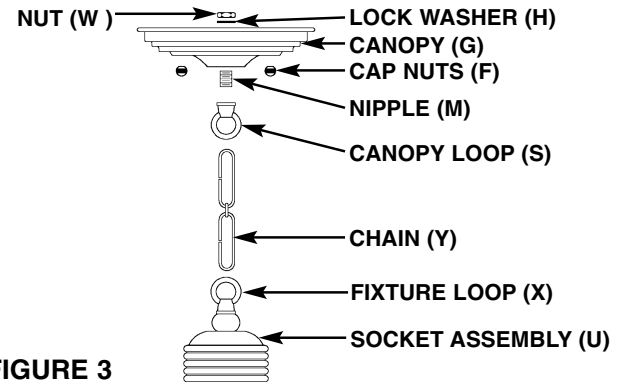

FIGURE 3

## ASSEMBLY FOR CHAIN HUNG

### STEP 1:

Thread nipple (M) through canopy loop(s). Install canopy loop(s) through canopy (G), secure with lockwasher (H) and nut (W) (if applicable).

### STEP 2:

Install fixture loop (X) onto socket assembly (U).

### STEP 3:

Feed the fixture wire from the socket assembly (U), through the fixture loop (X), and canopy loop (S) (mounted on canopy (G)).



**sea gull lighting®**

## Installation And Safety Instruction

**HC-387 072406**

Line art shown may not exactly match the fixture enclosed. However, the installation instructions do apply to this fixture.

Fill In Item Number On Carton And File This Sheet For Fixture Reference. ITEM# \_\_\_\_\_

## INSTALLATION

HC-387

**IMPORTANT: DO NOT ATTACH FIXTURE DIRECTLY TO OUTLET BOX.**

### FOR STEM MOUNT AND CHAIN HUNG

#### STEP 1:

Hold mounting bar with flat strap (B) behind offset strap (C). Rotate straps so they are at right angles to one another.

#### STEP 2:

Insert fixture mounting screws (I) in threaded holes of offset strap (C). Run screws all the way down to the heads.

#### STEP 3:

Place flat strap (B) of mounting bar against outlet box (not supplied) and fasten mounting bar, through slots in flat strap (B), to outlet box with outlet box screws (K) (not supplied). Be sure the mounting screws are perfectly horizontal so fixture hangs straight.

### FOR CHAIN HUNG ONLY

#### STEP 1:

Using 2 pair of pliers, open one link of chain (Y) and connect it to the fixture loop (X) at the top of the fixture.

**BE SURE TO CLOSE ALL CHAIN LINKS COMPLETELY.**

#### STEP 2:





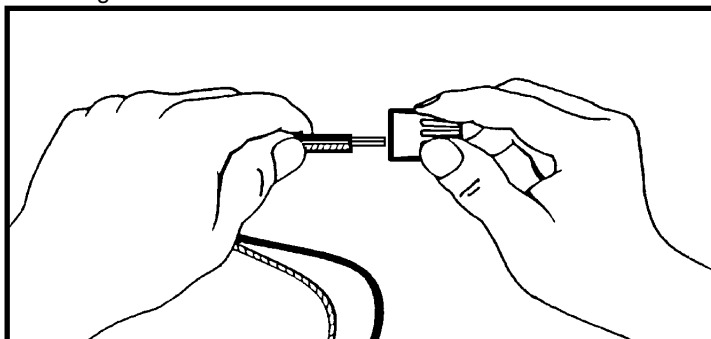

Lace fixture wire up through entire chain (Y) and pass through canopy loop (S). We recommend lacing wire up through every other link of chain (Y).

## WIRING

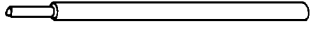
#### STEP 1:

A. Take note of the color of the wire(s) on your fixture. Identify which group your fixture wire(s) falls into and connect the wires according to the directions below:



GROUP A: CONNECT TO BLACK HOUSE WIRE	GROUP B: CONNECT TO WHITE HOUSE WIRE
BLACK 	WHITE 
*PARALLEL WIRE (ROUND & SMOOTH) 	*PARALLEL WIRE (SQUARE & RIDGED) 
WHITE OR GREY WITH TRACER 	WHITE OR GREY WITHOUT TRACER 
BROWN, GOLD OR BLACK WITHOUT TRACER 	BROWN, GOLD OR BLACK WITH TRACER 

\*NOTE: When parallel wire is used, the tracer wire is square shaped or ridged, and the less tracer wire is round in shape or smooth. (Seen best when viewed from wire end.) To separate wires, grasp the ends of each wire and pull apart.

B. Take your fixture wire(s) from group A and place evenly against the black wire from the outlet box. **DO NOT** twist wires together before using wire connectors.

C. Fit a wire connector (not supplied) over the wires and screw the connector clockwise until you feel a firmness.

D. Try gently to pull the connector off the wires. If you can pull the connector off, carefully re-do steps B and C, as above, and check again for a firm connection.

E. Connect the fixture wire from group B to the white wire from the outlet box in the same manner.

#### STEP 2:

**GROUNDING INSTRUCTIONS:** The green grounding screw (D) is to be inserted into the hole with two raised dimples provided on the mounting bar. Wrap the ground wire from the fixture (if supplied) and the ground wire from the outlet box (bare metal or green insulated wire) around the green grounding screw (D) on the mounting bar. If uninsulated wire is on the mounting bar, connect the ground wire from the fixture (if supplied) and the outlet box to it using a small wire connector (not supplied).

NOTE: Underwriters Laboratories (U.L.) does not require all fixtures to have ground wires. These fixtures still meet all U.L. specifications. The listing mark of Underwriters on the product identifies products manufactured under its listing and Follow-Up Service Programs.

**NEVER CONNECT GROUND WIRE TO BLACK OR WHITE POWER SUPPLY WIRES.**

## FINAL ASSEMBLY

**Make sure no bare wires can be seen outside wire connectors.**

### FOR STEM MOUNT AND CHAIN HUNG

#### STEP 1:

After wires are connected, tuck them carefully inside outlet box and then raise the canopy (G) against ceiling allowing for mounting screws (I) to protrude through holes in canopy (G). Secure in place with cap nuts (F).

#### STEP 2:

Place diffuser ring (Z) over diffuser (R) (if applicable). Raise diffuser (R) to socket assembly (U). Secure with retaining ring (T).

#### STEP 3:

Install lamp.

## CLEANING

To clean, wipe fixture body with a soft cloth. Clean glass with a mild soap. Do not use abrasive materials such as scouring pads or powders, steel wool or abrasive paper.

#### \*NOTE:

\* For Solid Copper Fixtures\*

Use a good quality automotive wax at least twice a year to protect your fixture. If this additional care is not taken, your fixture will turn into a Patina Finish over time.

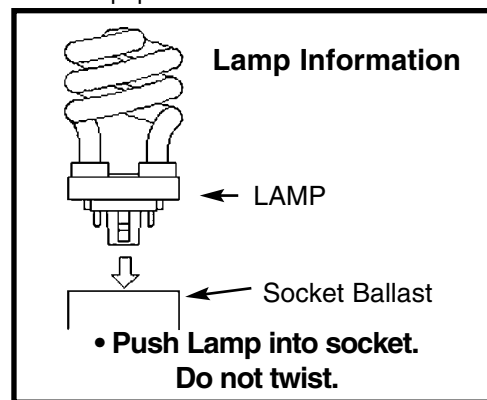

## ORDERING PARTS

Keep this sheet for future reference, and in case you need to order replacement parts. All parts for this fixture can be ordered from place of purchase. Be sure to use exact wording from illustration when ordering parts.