

varaLuz

Item #151C03
Artículo #151C03

Pendant

Lámpara colgante



To Begin/Para Comenzar

! **WARNING:** Review important safety instructions on second page before installation. Check to make sure you have the following tools:
ADVERTENCIA: Revise las instrucciones importantes de seguridad

Required
Necesario

Helpful
Útil



Flathead screwdriver
Destornillador plano



Phillips screwdriver
Destornillador de estrella

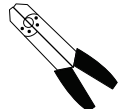

Wire strippers
Pelacables



Pliers
Alicate



Wire cutters
Cortacables

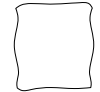

Soft cloth
Tela de material suave



Safety glasses
Lentes de protección



Step ladder
Escalera de tijera



Level
Nivel



Electrical tape
Cinta aislante

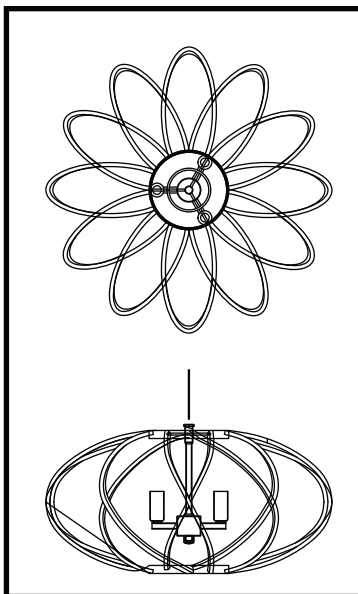

Included Hardware Partes incluidas



40-watt G9 halogen
lightbulb (3)
Bombillas tipo G9 de 40
vatios (3)



Mounting plate (1)
Placa de fijación (1)



Wire nut (2)
Cono aislante para
empalmes (2)



Ground screw, green (1)
Tornillo a tierra, verde (1)



Mounting screw (2)
Tornillo de montura (2)



Questions, problems, missing parts? Contact our Customer Care Center: 1-702-792-6900
Tiene preguntas, problemas, o faltan partes? Comuníquese con nuestro centro de Atención al Cliente: 1-702-792-6900

Safety Instructions

▲ WARNING: FOR YOUR PROTECTION AND SAFETY - Carefully read and understand the information given in this manual before beginning the assembly and installation. Failure to do so could lead to electric shock, fire or other injuries which could be hazardous or even fatal.

1. All electrical connections must be in agreement with local codes, ordinances or the national electric code (NEC). Contact your municipal building department to learn about your local codes, permits and/or inspections. **WARNING: RISK OF FIRE - MOST DWELLINGS BUILT BEFORE 1985 HAVE SUPPLY WIRE RATED FOR 60°C. CONSULT A QUALIFIED ELECTRICIAN BEFORE INSTALLATION.**
2. **TURN OFF ELECTRICITY** at main fuse box (or circuit breaker box) before beginning installation by switching circuit breaker off or removing fuse.
3. **DO NOT** connect this fixture to an electrical system that does not provide a means for equipment grounding. Never use a fixture in a two-wire system that is not grounded. **WARNING: INSTALLING A FIXTURE INTO AN ELECTRICAL SYSTEM NOT HAVING A PROPER GROUNDING MEANS COULD ALLOW ALL METAL PARTS OF THE FIXTURE TO CARRY ELECTRICAL CURRENT IF ANY OF THE FIXTURE WIRES, WIRE CONNECTIONS OR SPLICES BECOME BROKEN, CUT OR LOOSE DURING THE MOUNTING OR NORMAL OPERATION OF THE FIXTURE, UNDER THIS CONDITION, ANYONE COMING IN CONTACT WITH THE FIXTURE IS SUBJECT TO ELECTRICAL SHOCK, WHICH COULD CAUSE SERIOUS INJURY OR DEATH.**
4. If you are not sure your lighting system has a grounding means, **DO NOT** attempt to install this fixture. Contact a qualified, licensed electrician for information with regards to proper grounding methods as required by the local electrical code in your area.
5. **DO NOT** connect the bare or green insulation fixture ground wire to the black (HOT) current carrying wire or white neutral house wire. **WARNING: CONNECTION OF THE BARE OR GREEN FIXTURE GROUND WIRE TO THE BLACK OR WHITE HOUSE WIRES MAY ALLOW ALL METAL PARTS OF THE FIXTURE TO CARRY ELECTRICAL CURRENT. UNDER THIS CONDITION ANYONE COMING IN CONTACT WITH THE FIXTURE WILL RECEIVE ELECTRICAL SHOCK, WHICH COULD CAUSE SERIOUS INJURY OR DEATH.**
6. **DO NOT** suspend any fixture by the house wires. A fixture must always be mounted directly to an outlet box or to a mounting strap which is first attached to the outlet box. **WARNING: WIRE CONNECTORS WILL NOT SUPPORT THE WEIGHT OF A FIXTURE. SUSPENDING A FIXTURE BY THE HOUSE WIRES AND WIRE CONNECTORS WILL RESULT IN THE FIXTURE FALLING, WITH THE POSSIBILITY OF PERSONAL INJURY AND THE DANGER OF ELECTRICAL SHOCK OR FIRE.**
7. All fixtures must be mounted to an outlet box that is supported by the building structure. **DO NOT** attempt to support the fixture by ceiling board alone. Ceiling board alone does not have the strength to support the weight of the fixture. The fixture may fall and cause personal injury.
8. **BE CAREFUL** not to damage or cut the wire insulation (covering) during fixture installation. **DO NOT** permit wires to contact any surface having a sharp edge. To do so may damage or cut the wire insulation which could cause serious injury or death from electric shock.
9. **DO NOT** use lamps (bulbs) having a greater wattage than the maximum value stated on the fixture. The use of a higher wattage lamp(s) than specified will increase temperatures and cause the risk of fire.
10. If a dimmer control switch is used with this fixture, obtain professional advice to determine the correct type and electrical rating required.

Instrucciones de seguridad

▲ ADVERTENCIA: PARA SU PROTECCION Y SEGURIDAD- Lea cuidadosamente y obtenga una clara idea de la información en este manual antes de iniciar el ensamblaje e instalación descrita en las páginas que siguen. El ignorar esto podría causar un choque eléctrico, incendio u otros daños que pueden ser peligrosos y hasta fatales.

1. Todas las conexiones eléctricas deben estar de acuerdo con el código y las ordenanzas locales, o el código eléctrico nacional (NEC, siglas en inglés). Póngase en contacto con el departamento de construcción de la municipalidad para ilustrarse respecto a los códigos, licencias y/o inspecciones locales. **ADVERTENCIA: RIESGO DE INCENDIO - LA MAYORIA DE EDIFICIOS CONSTRUIDOS ANTES DE 1985 TIENEN CABLES DE ALIMENTACION CON CAPACIDAD TERMICA NOMINAL DE 60°C. CONSULTE CON UN ELECTRICISTA CALIFICADO ANTES DE LA INSTALACION.**
2. **CORTE LA ELECTRICIDAD** en la caja principal de fusibles (o la caja del interruptor automático) antes de comenzar la instalación, apagando el interruptor o quitando el fusible.
3. **NO CONECTE** este artefacto a un sistema eléctrico que no tiene conexión a tierra. Nunca use un artefacto en un sistema eléctrico de dos cables sin conexión a tierra. **ADVERTENCIA: EL INSTALAR UN APARATO EN UN SISTEMA SIN CONEXION A TIERRA APROPRIADA, PODRIA CAUSAR QUE TODAS LAS PARTES METALICAS DEL APARATO SE ELECTRIFIQUEN. SI SUCEDE QUE CUALQUIERA DE LOS CABLES DEL APARATO, LAS CONEXIONES O EMPALMES SE ROMPAN, SE CORTEN O SE SUELTEN DURANTE EL ENSAMBLAJE O LA OPERACION DEL APARATO, ENTONCES CUALQUIER PERSONA QUE SE PONGA EN CONTACTO CON EL APARATO ESTA EN PELIGRO DE RECIBIR UN CHOQUE ELECTRICO QUE PUEDE CAUSAR LESIONES GRAVES Y AUN LA MUERTE.**
4. Si usted no está seguro de que su sistema de alumbrado tiene medios para conexión a tierra, **NO INTENTE** instalar este aparato. Contacte a un electricista licenciado y calificado para informarse sobre métodos apropiados para instalar la conexión a tierra requerida por el código eléctrico de su localidad.
5. **NO CONECTE** el cable a tierra desnudo o el de aislamiento verde, al negro (POSITIVO) portador de la electricidad o al blanco neutro proveniente de la casa. **ADVERTENCIA: EL CONECTAR EL CABLE A TIERRA DESNUDO O EL VERDE DEL APARATO, AL CABLE NEGRO O AL BLANCO DE LA CASA, PUEDE HACER QUE TODAS LAS PARTES METALICAS DEL APARATO SE ELETRIFIQUEN. BAJO ESTAS CONDICIONES CUALQUIER PERSONA QUE SE PONGA EN CONTACTO CON EL APARATO RECIBIRA UN CHOQUE ELECTRICO QUE PUEDE CAUSAR LESIONES GRAVES Y AUN LA MUERTE.**
6. **NO CUELQUE** ningún aparato de los alambres eléctricos de la casa. Un aparato siempre debe montarse directamente a una caja de salida o a una barra para artefactos previamente montada sobre la caja de salida. **ADVERTENCIA: LOS CABLES DE CONEXION NO SOPORTARAN EL PESO DE UN APARATO. EL COLGAR DE LOS CABLES DE LA CASA Y LOS CONECTORES RESULTARA EN LA CAIDA DEL APARATO Y LA POSIBILIDAD DE LESIONES PERSONALES Y EL PELIGRO DE CHOQUE ELECTRICO O INCENDIO.**
7. Todos los aparatos deben sujetarse a una caja de salida que esté sujeta a la estructura del edificio. **NO INTENTE** sujetar el aparato solamente al cielo raso. El cielo raso no tiene la fuerza para soportar el peso del aparato. El aparato se puede caer y causar lesiones personales.
8. **TENGA CUIDADO** de no dañar o cortar el aislamiento (la cubierta) del cable durante la instalación del aparato. **NO PERMITA** que los cables estén en contacto con ninguna superficie de borde afilado. El hacerlo, causará daño o cortará el aislamiento del cable, lo que podría causar serios daños o la muerte por choque eléctrico.
9. **NO USE** bombillas (focos) de mayor cantidad de vatios que el máximo mencionado en el aparato. Usar bombillas de más vatios que lo especificado aumentará la temperatura y provocará un riesgo de incendio.
10. Si se utiliza un reductor de intensidad de luz con este aparato, obtenga asesoría profesional para determinar el tipo correcto y el amperaje necesario.



Drop Instructions

Drops and Part List

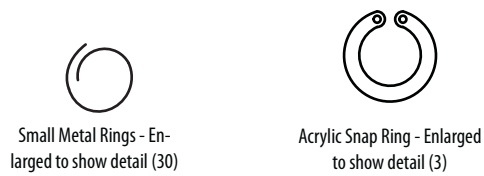

Glass Drop Ring Assembly

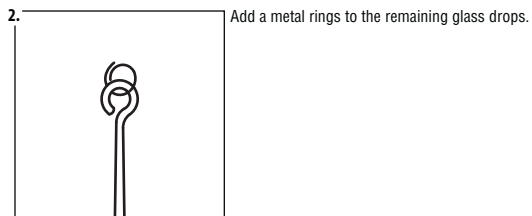
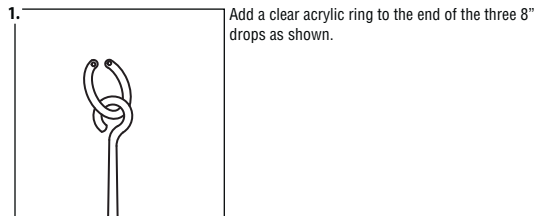

Drop Instructions Continued

8" Drop Locations (3 on arms) ●

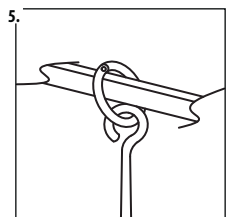
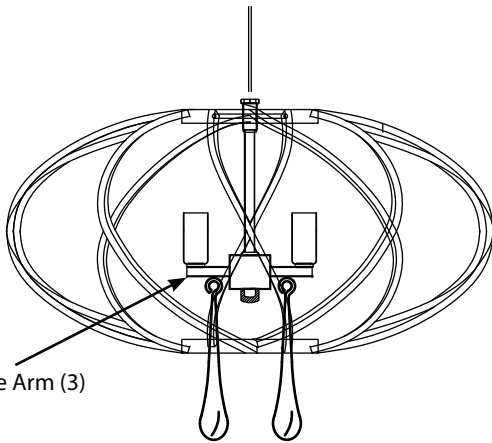
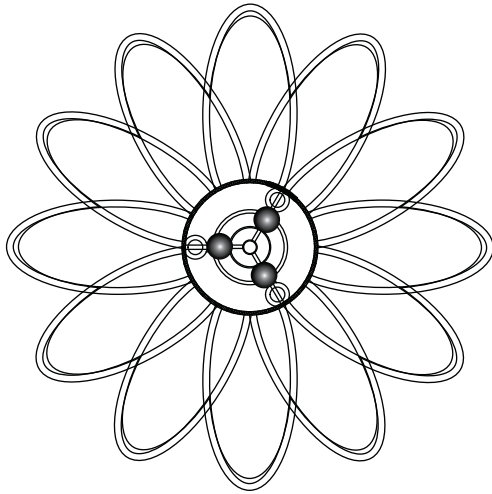

5. Using the 8" drop with the acrylic rings. Gently bend open the acrylic ring to go over the fixture arm. Once over the arm snap the 2 ends of the ring together to lock it into place. (Shown on left).

12" Drop Locations (6 on top inner ring) ●

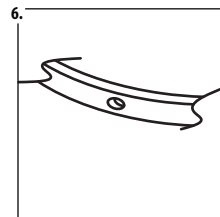
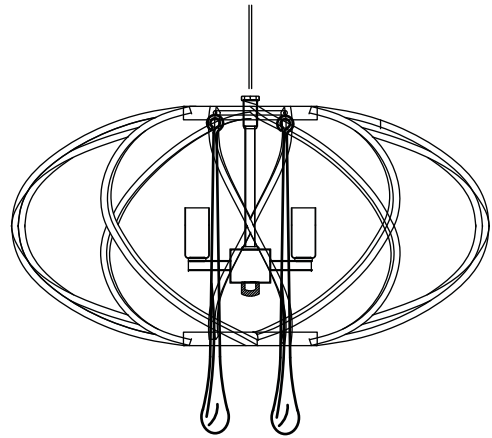
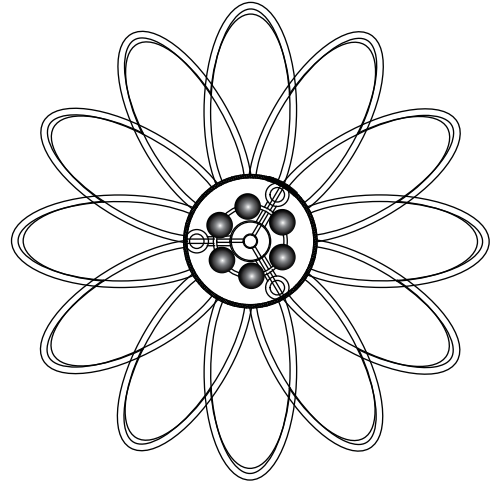

6. Locate the holes on the inner ring of the fixture as shown above. You will find small holes for the rings to slide in as shown to the left

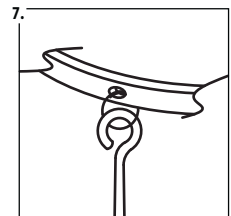

7. Using the 12" drops with rings, open the ring slightly and slip them through the hole on the fixture as shown.



Drop Instructions Continued

6" Drop Locations (12 on top outer ring) ●

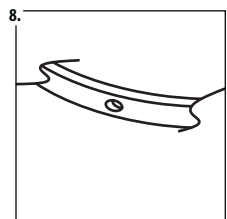
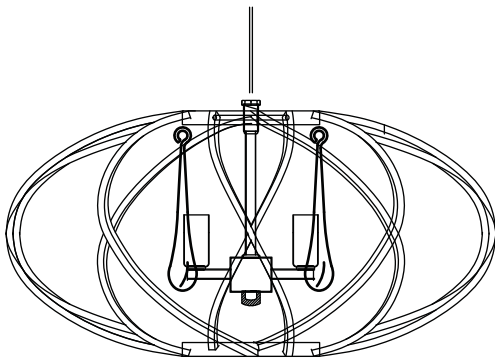
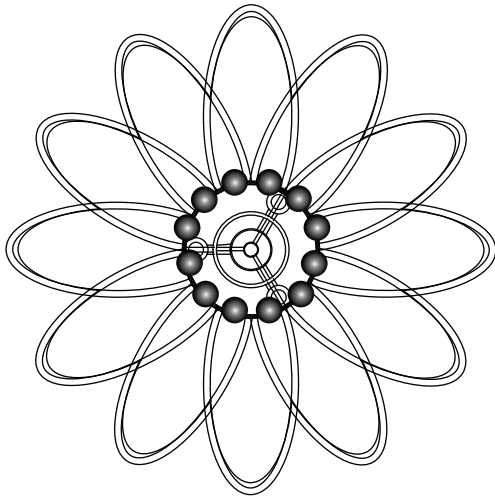

8. Locate the holes on the outer ring of the fixture as shown above. You will find small holes for the rings to slide in as shown to the left

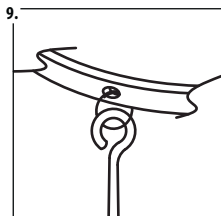

Using the 6" drops with rings, open the ring slightly and slip them through the hole on the fixture as shown.

6" Drop Locations (12 on every other arm) ●

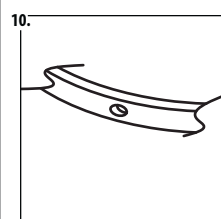
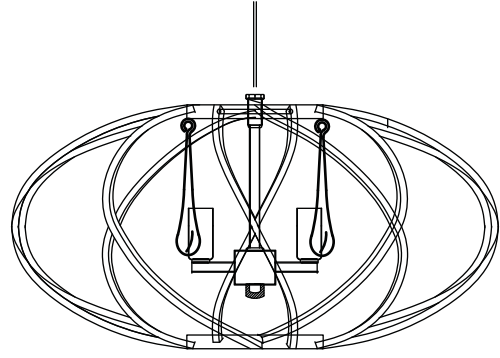
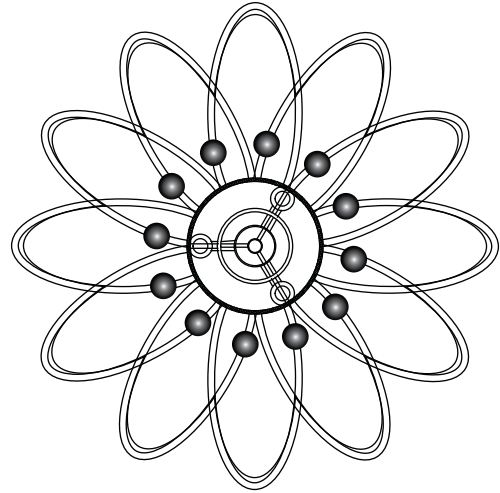

10. Locate the holes on the outer ring of the fixture as shown above. You will find small holes for the rings to slide in as shown to the left

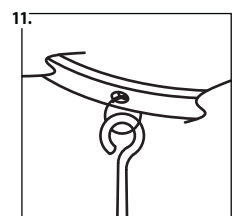

Using the 6" drops with rings, open the ring slightly and slip them through the hole on the fixture as shown.

