

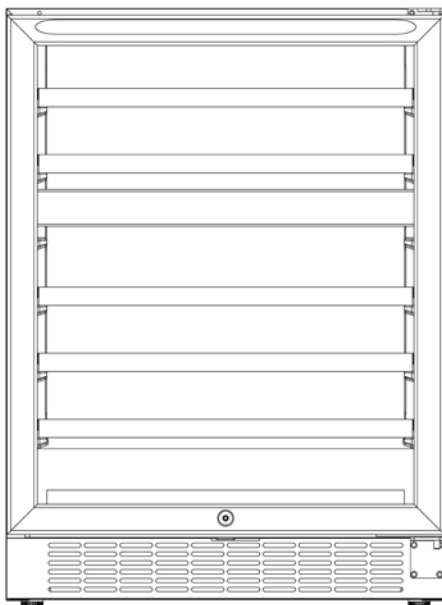

**DUAL ZONE WINE CHILLER / VINERA CON 2 ZONAS  
INSTRUCTION MANUAL  
MANUAL DE INSTRUCCIONES**

**Model Number / No. de Modelo: WCR5450DZ**



**WCR5450DZ**

**BEFORE USE, PLEASE READ AND FOLLOW ALL SAFETY RULES AND OPERATING INSTRUCTIONS.**

La sección en español empieza en la página 16.

Avanti Products has a policy of continuous improvement on its products and reserves the right to change materials and specifications without notice.

---

**Avanti Products, A Division of The Mackle Co., Inc.  
P.O. Box 520604 - Miami, Florida 33152  
[www.avantiproducs.com](http://www.avantiproducs.com)**

---

## TABLE OF CONTENTS

|   |         |
|---|---------|
| Appliance Safety                                | 3       |
| Important Safeguides                            | 4       |
| Help Us Help You ...                            | 5       |
| Parts and Features                              | 6       |
| Important Safety Instructions                   | 7       |
| Installation Instructions                       | 7       |
| Before Using Your Wine Chiller                  | 7       |
| Installation of Your Wine Chiller               | 7       |
| Electrical Connection                           | 8       |
| Extension Cord                                  | 8       |
| Reversing the Door Swing of Your Wine Appliance | 8       |
| Operating Your Wine Chiller                     | 9       |
| ON/OFF Power                                    | 9       |
| Setting the Temperature Control                 | 9       |
| Storage   | 10      |
| Interior Light                                  | 10      |
| Shelves   | 10 – 11 |
| Care and Maintenance                            | 12      |
| Cleaning Your Wine Chiller                      | 12      |
| Power Failure                                   | 12      |
| Vacation Time                                   | 12      |
| Moving Your Wine Chiller                        | 12      |
| Energy Saving Tips                              | 12      |
| Troubleshooting Guide                           | 13      |
| Service for Your Appliance                      | 14      |
| Wiring Diagram                                  | 14      |
| Your Avanti Products Warranty                   | 15      |
| Instrucciones en Español                        | 16 – 18 |
| Registration Information and Registration Card  | 19      |

## APPLIANCE SAFETY

**Your safety and the safety of others are very important.**

We have provided many important safety messages in this manual and on your appliance. Always read and obey all safety messages.



This is the Safety Alert Symbol. This symbol alerts you to potential hazards that can kill or injure you and others. All safety messages will follow the Safety Alert Symbol and either the words "DANGER", "WARNING" or "CAUTION".



Danger means that failure to heed this safety statement may result in severe personal injury or death.



Warning means that failure to heed this safety statement may result in extensive product damage, serious personal injury, or death.



Caution means that failure to heed this safety statement may result in minor or moderate personal injury, or property or equipment damage.

All safety messages will alert you do what the potential hazard is, tell you how to reduce the chance of injury, and let you know what can happen if the instructions are not followed.

## IMPORTANT SAFEGUIDES



Before the appliance is used, it must be properly positioned and installed as described in this manual, so read the manual carefully. To reduce the risk of fire, electrical shock or injury when using the appliance, follow basic precaution, including the following:

### **DANGER**

- Plug into a grounded 3-prong outlet, do not remove grounding prong, do not use an adapter, and do not use an extension cord.
- Replace all panels before operating.
- It is recommended that a separate circuit, serving only your appliance be provided. Use receptacles that cannot be turned off by a switch or pull chain.
- Never clean appliance parts with flammable fluids. These fumes can create a fire hazard or explosion. And do not store or use gasoline or other flammable vapors and liquids in the vicinity of this or any other appliance. The fumes can create a fire hazard or explosion.
- Before proceeding with cleaning and maintenance operations, make sure the power line of the unit is disconnected.
- Do not connect or disconnect the electric plug when your hands are wet.
- Unplug the appliance or disconnect power before cleaning or servicing. Failure to do so can result in electrical shock or death.
- Do not attempt to repair or replace any part of your appliance unless it is specifically recommended in this material. All other servicing should be referred to a qualified technician.

### **WARNING**

FOLLOW WARNING CALL OUTS BELOW ONLY WHEN APPLICABLE TO YOUR MODEL

- Use two or more people to move and install appliance. Failure to do so can result in back or other injury.
- To ensure proper ventilation for your appliance, the front of the unit must be completely unobstructed. Choose a well-ventilated area with temperatures above 60°F (16°C) and below 90°F (32°C). This unit must be installed in an area protected from the element, such as wind, rain, water spray or drips.
- The appliance should not be located next to ovens, grills or other sources of high heat.
- The appliance must be installed with all electrical connections in accordance with state and local codes. A standard electrical supply (115 V AC only, 60 Hz), properly grounded in accordance with the National Electrical Code and local codes and ordinances is required.
- Do not kink or pinch the power supply cord of appliance.
- The fuse (or circuit breaker) size should be 15 amperes.
- It is important for the appliance to be leveled in order to work properly. You may need to make several adjustments to level it.
- Never allow children to operate, play with or crawl inside the appliance.
- Although the unit has been tested at the factory, due to long-term transit and storage, the first batch of cubes must be discarded.
- Do not use solvent-based cleaning agents or abrasives on the interior. These cleaners may damage or discolor the interior.
- Do not use this apparatus for other than its intended purpose.

---

## HELP US HELP YOU...

### Read this guide carefully.

It is intended to help you operate and maintain your new Wine Chiller properly.

Keep it handy to answer your questions. If you don't understand something or you need more assistance, please call:

**Avanti Customer Service**  
**800-220-5570**

Keep proof of original purchase date (such as your sales slip) with this guide to establish the warranty period.

### **CAUTION:**

THIS WINE CHILLER IS NOT DESIGNED FOR THE STORAGE OF MEDICINE OR OTHER MEDICAL PRODUCTS.

### Write down the model and serial numbers.

You'll find them on a plate located on the rear outside wall of the Wine Chiller.

Please write these numbers here:

\_\_\_\_\_  
Date of Purchase

\_\_\_\_\_  
Model Number

\_\_\_\_\_  
Serial Number

Use these numbers in any correspondence or service calls concerning your Wine Chiller.

If you received a damaged Wine Chiller, immediately contact the dealer (or builder) that sold you the Wine Chiller.

Save time and money. Before you call for service, check the Troubleshooting Guide. It lists causes of minor operating problems that you can correct yourself.

---

## IF YOU NEED SERVICE

We're proud of our service and want you to be pleased. If for some reason you are not happy with the service you receive, here are some steps to follow for further assistance.

FIRST, contact the people who serviced your Wine Chiller. Explain why you are not pleased. In most cases, this will solve the problem.

NEXT, if you are still not pleased, write all the details, including your telephone number, and send it to:

**Customer Service**  
**Avanti Products**  
**10880 NW 30 Street**  
**Miami, FL 33172 USA**

## PARTS & FEATURES

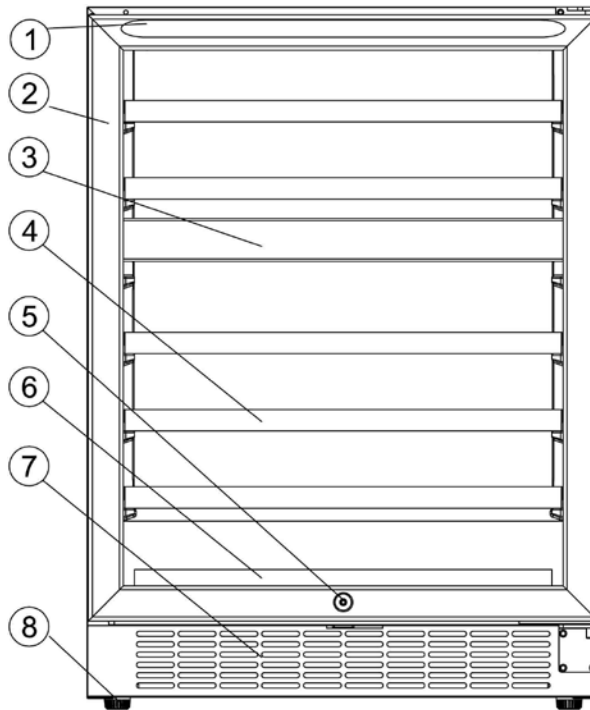

**WCR5450DZ**

1. **STAINLESS STEEL HANDLE**
2. **GLASS DOOR WITH STAINLESS STEEL FRAME**
3. **TEMPERATURE CONTROL PANEL**
4. **ROLL-OUT SHELVES (TOTAL 5)**
5. **SECURITY LOCK**
6. **SMALL BOTTOM SHELF (TOTAL 1)**
7. **FRONT GRILLE**
8. **LEVELING LEGS**
9. **CABINET**

## IMPORTANT SAFETY INSTRUCTIONS

|  |   |
|--|---|
|   | <p>To reduce the risk of fire, electrical shock, or injury when using your appliance, follow these basic precautions:</p> |
| <ul style="list-style-type: none"> <li>• Read all instructions before using the Wine Chiller.</li> <li>• <b>DANGER or WARNING:</b> Risk of child entrapment.<br/>Child entrapment and suffocation are not problems of the past. Junked or abandoned appliances are still dangerous . . . even if they will “just sit in the garage a few days”.</li> <li>• <b>Before you throw away your old Wine Chiller:</b> Take off the door. Leave the shelves in place so that children may not easily climb inside.</li> <li>• Never allow children to operate, play with, or crawl inside the appliance.</li> <li>• Never clean appliance parts with flammable fluids. The fumes can create a fire hazard or explosion.</li> <li>• Do not store or use gasoline or any other flammable vapors and liquids in the vicinity of this or any other appliance. The fumes can create a fire hazard or explosion.</li> </ul> <p style="text-align: center;">-Save these instructions-</p> |   |

## INSTALLATION INSTRUCTIONS

### ➤ BEFORE USING YOUR WINE CHILLER

- Remove the exterior and interior packing.
- Check to be sure you have all of the following parts:
  - 5 Roll-out Shelves
  - 1 Small Bottom Shelf
  - 1 Instruction Manual
- Before connecting the Wine Chiller to the power source, let it stand upright for approximately 2 hours. This will reduce the possibility of a malfunction in the cooling system from handling during transportation.
- Clean the interior surface with lukewarm water using a soft cloth.

### ➤ INSTALLATION OF YOUR WINE CHILLER

- This appliance is designed to be for built-in, recessed or free standing installation.
- Place your Wine Chiller on a floor that is strong enough to support it when it is fully loaded. To level your Wine Chiller, adjust the front leveling legs at the bottom of the Wine Chiller.
- Locate the Wine Chiller away from direct sunlight and sources of heat (stove, heater, radiator, etc.). Direct sunlight may affect the protective coating and heat sources may increase electrical consumption. Extreme cold ambient temperatures may also cause the unit not to perform properly.
- Avoid locating the unit in moist areas.
- Do not let anything cover or obstruct the ventilation grilles.
- Plug the Wine Chiller into an exclusive, properly installed-grounded wall outlet. Do not under any circumstances cut or remove the third (ground) prong from the power cord. Any questions concerning power and/or grounding should be directed toward a certified electrician or an authorized Avanti Products service center.

| Cabinet Opening Dimensions |                                  |             |
|----------------------------|----------------------------------|-------------|
|                            | Inches                           | Centimetres |
| Width                      | 23 <sup>5</sup> / <sub>8</sub> " | 60 cm       |
| Depth                      | 23 <sup>1</sup> / <sub>4</sub> " | 59 cm       |
| Height                     | 34"                              | 86.5 cm     |

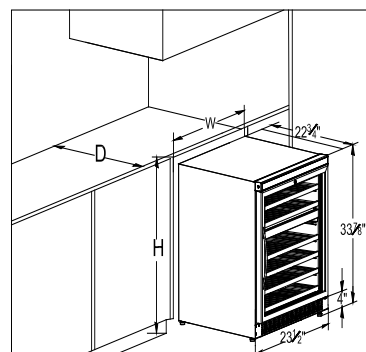

➤ **ELECTRICAL CONNECTION**

**⚡ Warning ⚡**

Improper use of the grounded plug can result in the risk of electrical shock. If the power cord is damaged, have it replaced by an authorized Avanti Products service center.

This appliance should be properly grounded for your safety. The power cord of this appliance is equipped with a three-prong plug which mates with standard three prong wall outlets to minimize the possibility of electrical shock.

Do not under any circumstances cut or remove the third ground prong from the power cord supplied. For personal safety, this appliance must be properly grounded.

This appliance requires a standard 115/120 Volt AC ~/60Hz electrical ground outlet with three-prong. Have the wall outlet and circuit checked by a qualified electrician to make sure the outlet is properly grounded. When a standard 2-prong wall outlet is encountered, it is your responsibility and obligation to have it replaced with a properly grounded 3-prong wall outlet.

The cord should be secured behind the appliance and not left exposed or dangling to prevent accidental injury.

The appliance should always be plugged into its own individual electrical outlet which has a voltage rating that matches the rating label on the appliance. This provides the best performance and also prevent overloading house wiring circuits that could cause a fire hazard from overheated. Never unplug the appliance by pulling the power cord. Always grip the plug firmly and pull straight out from the receptacle. Repair or replace immediately all power cords that have become frayed or otherwise damaged. Do not use a cord that shows cracks or abrasion damage along its length or at either end. When moving the appliance, be careful not to damage the power cord.

➤ **EXTENSION CORD**

Because of potential safety hazards under certain conditions, it is strongly recommended that you do not use an extension cord with this appliance. However, if you must use an extension cord it is absolutely necessary that it be a UL/CUL-Listed, 3-wire grounding type appliance extension cord having a grounding type plug and outlet and that the electrical rating of the cord be 115 volts and at least 10 amperes.

➤ **SURGE PROTECTOR**

Most electrical appliances use a series of electric control boards to operate. These boards are very susceptible to power surges and could be damaged or destroyed.

If the appliance is going to be used in an area or if your city / country is prone to power surges / outages; it is suggested that you use a power surge protector for all electrical devices / appliances you use. The surge protector that you select must have a surge block high enough to protect the appliance it is connected to. If you have any questions regarding the type and size of surge protector needed contact a licensed electrician in your area.

Damages due to power surges are not considered a manufacturer covered defect and will void your product warranty.



## OPERATING YOUR WINE CHILLER

It is recommended you install the Wine Chiller in a place where the ambient temperature is between 72-78 degrees Fahrenheit. If the ambient temperature is above or below recommended temperatures, the performance of the unit may be affected. For example, placing your unit in extreme cold or hot conditions may cause interior temperatures to fluctuate. The range of 40-65 degrees Fahrenheit may not be reached.

Recommended Temperatures for Chilling Wine.

|                   |            |            |
|-------------------|------------|------------|
| Red Wines         | 59 - 65 °F | 15 - 18 °C |
| Dry / White Wines | 50 - 55 °F | 10 - 13 °C |
| Rose Wines        | 49 - 51 °F | 9 – 11 °C  |
| Sparkling Wines   | 40 - 47 °F | 5 - 8 °C   |

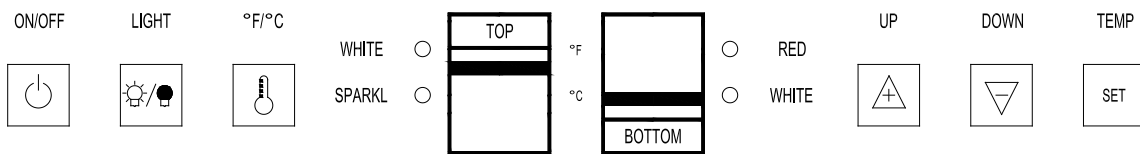



### ➤ ON/OFF POWER

To turn ON or OFF the appliance, press the **ON/OFF** button 







The LED readout will show the original temperature set previously (the preset temperature at the factory for TOP ZONE is 50°F/10°C and for BOTTOM ZONE is 60°F/16°C).

You can select temperature display setting from Fahrenheit to Celsius degree by pushing the **°F/°C**  button. Fahrenheit or Celsius degrees indicators will appear in blue color in the temperature display windows for each zone.

### ➤ SETTING THE TEMPERATURE CONTROL

You can press **UP**  or **DOWN**  buttons to get the desired temperature in each zone.

Before setting temperature, you need to press **SET** button to select the desired temperature zone first. The degrees indicators will appear in the display windows marked TOP ZONE and BOTTOM ZONE.

- **Top Zone.**  
Then press the **UP**  or **DOWN**  buttons to get the desired temperature in the top zone. The LED indicator on the TOP ZONE display will flash
- **Bottom Zone.**  
Then press the **UP**  or **DOWN**  buttons to get the desired temperature in the top zone. The LED indicator on the BOTTOM ZONE display will flash
- The temperature that you desire to set will increase 1°F or 1°C if you push the **UP**  button once, on the contrary the temperature will decrease 1°F or 1°C if you push the **DOWN**  button once.

The temperature range of TOP ZONE is 40 ~ 55°F/ 5 ~ 13°C which is suitable for storing sparkling and white wines. The temperature range of BOTTOM ZONE is 55 ~ 65 °F/13 ~ 18°C which is suitable for storing white and red wines.

- When you store mostly red wines, you should store them in the BOTTOM ZONE, the temperature which you control needs to be set at between 58 to 65°F/15°C to 18°C and the red LED lamp marked “RED” will be lit
- When you store mostly white wines, you can store them in the TOP ZONE or BOTTOM ZONE. When you use the BOTTOM ZONE, the temperature can be set at between 55 to 57°F/13° to 14°C and the green LED lamp marked “WHITE” will be lit. When you use the TOP ZONE, the temperature can be set at between 48 to 55°F/9 to 13°C and the green LED lamp marked “WHITE” will be lit.
- When you store mostly sparkling wines, you should store them in the UPPER ZONE, the temperature needs to be set at between 40 to 47°F/5 to 8°C and the amber LED lamp marked “SPARKL” will be lit.

**NOTE:**

- If the unit is unplugged, power lost, or turned off, you must wait 3 to 5 minutes before restarting the unit. If you attempt to restart before this time delay, the Wine Chiller will not start.
- When you use the wine chiller for the first time or restart the wine chiller after having been shut off for a long time, there could be a few degrees variance between the temperature you select and the one indicated on the LED readout. This is normal and it is due to the length of the activation time. Once the wine chiller is running for a few hours everything will be back to normal.



➤ **STORAGE**

Many bottles may differ in size and dimensions. As such the actual number of bottles you may be able to store may vary.

**NOTE:** You can place 16 standard bottles in the top zone and 30 standard bottles in the bottom zone.

➤ **INTERIOR LIGHT**

The interior lights are controlled automatically when the door is opened and closed. Once the door is opened, the lights will be ON and will turn OFF once the door is closed.

If you would like the light ON even after the door has been closed, press the /  button and the interior light will be turned ON. The light will automatically turn OFF after 10 minutes.

➤ **SHELVES**

This appliance is equipped with a pull-out roller assembly (except for the bottom shelf) and you can move the wooden shelves out and in smoothly.

**Pull-out Roller Shelves (Total 5)**

- To prevent damaging the door gasket, make sure to have the door all the way opened when pulling shelves out of the rail compartment.
- For easy access to the bottles, you must pull the shelves approximately 60% out of the rail compartment.

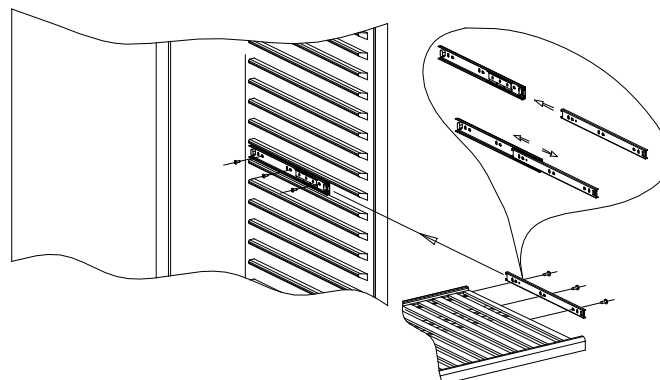

- To remove the shelves out of the rail pull each shelf approximately 60% out. Use a long flat screwdriver to press down the right plastic notch as shown in Figure A and at the same time lift the left plastic notch as shown in Figure B. Then proceed to pull out the shelf slowly. Contact our service department if assistance is needed.

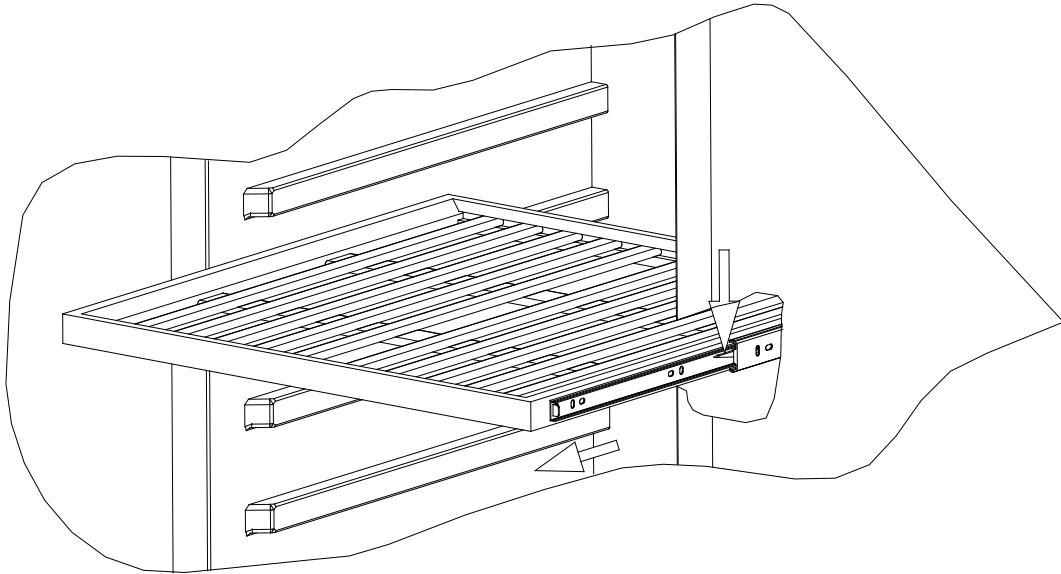

**Figure A**

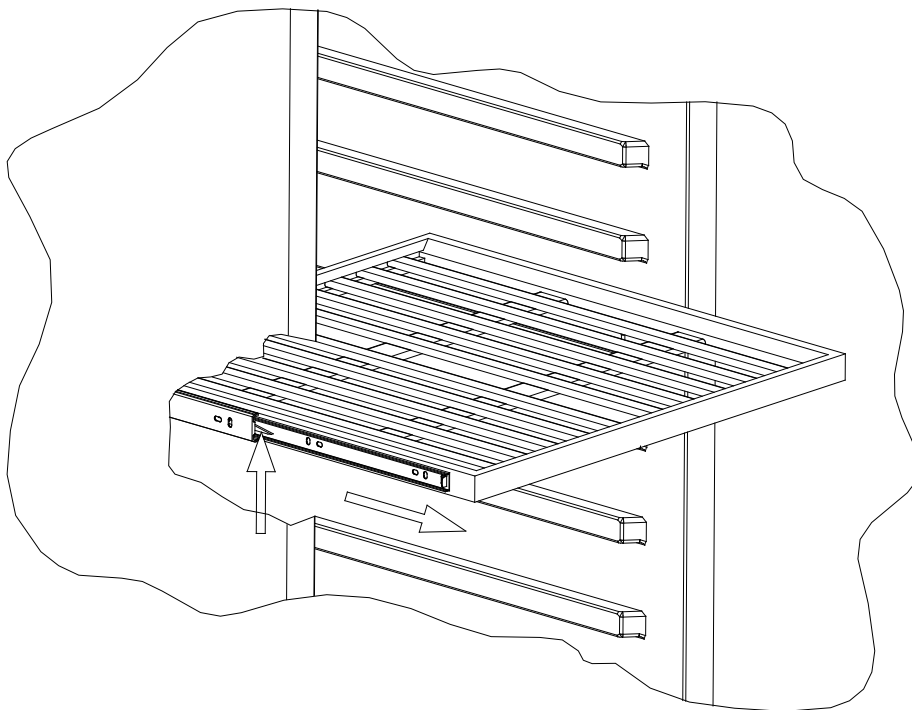

**Figure B**

## CARE AND MAINTENANCE

### ➤ CLEANING YOUR WINE CHILLER

- Turn off the power, unplug the appliance, and remove all items including shelves.
- Wash the inside surfaces with a warm water and baking soda solution. The solution should be about 2 tablespoons of baking soda to a quart of water.
- Wash the shelves with a mild detergent solution.
- Wring excess water out of the sponge or cloth when cleaning area of the controls, or any electrical parts.
- Wash the outside cabinet with warm water and mild liquid detergent or furniture polish.
- Rinse well and wipe dry with a clean soft cloth.
- Do not use steel wool or steel brush on the wooden outside cabinet. These will destroy the surface.

### ➤ POWER FAILURE

- Most power failures are corrected within a few hours and should not affect the temperature of your appliance if you minimize the number of times the door is opened. If the power is going to be off for a longer period of time, you need to take the proper steps to protect your contents.

### ➤ VACATION TIME

- **Short vacations:** Leave the Wine Chiller operating during vacations of less than three weeks.
- **Long vacations:** If the appliance will not be used for several months, remove all items and turn off the appliance. Clean and dry the interior thoroughly. To prevent odor and mold growth, leave the door open slightly: blocking it open if necessary.

### ➤ MOVING YOUR WINE CHILLER

- Remove all items.
- Securely tape down all loose items (shelves) inside your appliance.
- Turn the adjustable legs up to the base to avoid damage.
- Tape the door shut.
- Be sure the appliance stays secure in the upright position during transportation. Also protect outside of appliance with a blanket, or similar item.

### ➤ ENERGY SAVING TIPS

- The Wine Chiller should be located in the coolest area of the room, away from heat producing appliances, and out of the direct sunlight.

## PROBLEMS WITH YOUR WINE CHILLER?

You can solve many common Wine Chiller problems easily, saving you the cost of a possible service call. Try the suggestions below to see if you can solve the problem before calling the servicer.

### TROUBLESHOOTING GUIDE

| PROBLEM  | POSSIBLE CAUSE  |
|--|---|
| Wine Chiller does not operate.                 | Not plugged in.<br>The appliance is turned off.<br>The circuit breaker tripped or a blown fuse.   |
| Wine Chiller is not cold enough.               | Check the temperature control setting.<br>External environment may require a higher setting.<br>The door is opened too often.<br>The door is not closed completely.<br>The door gasket does not seal properly.  |
| Turns on and off frequently.                   | The room temperature is hotter than normal.<br>A large amount of contents has been added to the wine chiller.<br>The door is opened too often.<br>The door is not closed completely.<br>The temperature control is not set correctly.<br>The door gasket does not seal properly.                                      |
| The light does not work.                       | Not plugged in.<br>The circuit breaker tripped or a blown fuse.<br>The light button is "OFF".   |
| Vibrations.                                    | Check to assure that the Wine Chiller is level.   |
| The Wine Chiller seems to make too much noise. | The rattling noise may come from the flow of the refrigerant, which is normal.<br>As each cycle ends, you may hear gurgling sounds caused by the flow of refrigerant in your Wine Chiller.<br>Contraction and expansion of the inside walls may cause popping and crackling noises.<br>The Wine Chiller is not level. |
| The door will not close properly.              | The Wine Chiller is not level.<br>The door was reversed and not properly installed.<br>The gasket is dirty.<br>The shelves are out of position.   |

## SERVICE FOR YOUR WINE CHILLER

We are proud of our customer service organization and the network of professional service technicians that provide service on your Avanti appliances. With the purchase of your Avanti appliance, you can have the confidence that if you ever need additional information or assistance, the Avanti Products Customer Service team will be here for you. Just call us toll-free.

### AVANTI PRODUCTS CUSTOMER SERVICES

|   |  |
|---|--|
| <b>Product Information</b><br>800-323-5029    | Whatever your questions are about our products, help is available.   |
| <b>Part Orders</b><br>800-220-5570            | You may order parts and accessories that will be delivered directly to your home by personal check, money order, Master Card, or Visa.   |
| <b>In-Home Repair Service</b><br>800-220-5570 | An Avanti Products authorized service center will provide expert repair service, scheduled at a time that is convenient for you. Our trained servicers know your appliance inside and out. |

### WIRING DIAGRAM

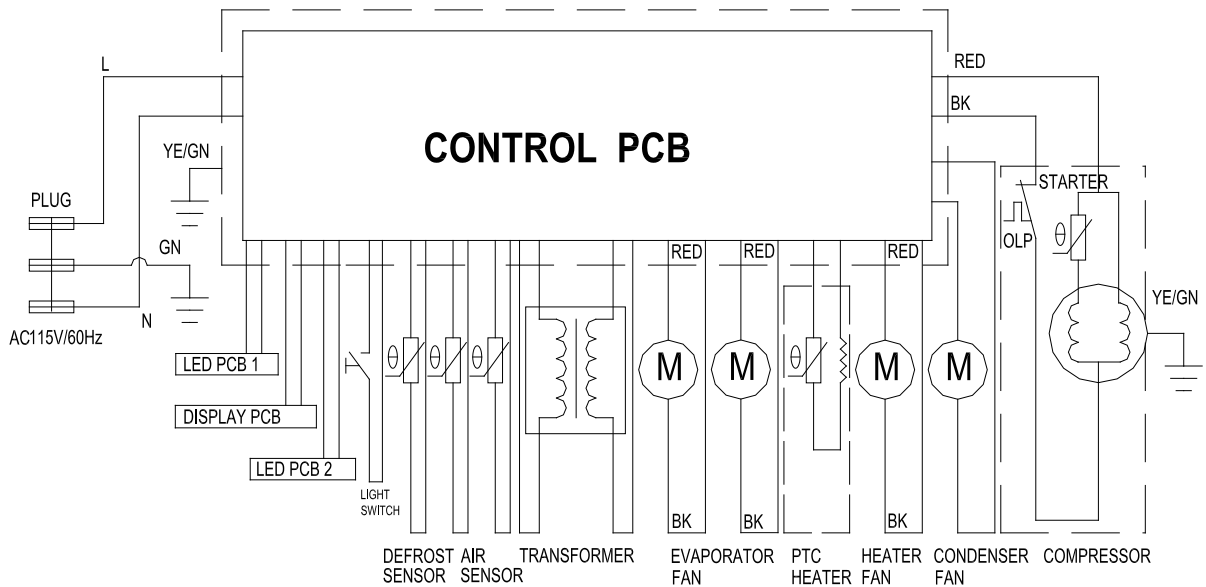

**YOUR Avanti Products WARRANTY**

**Staple your sales receipt here. Proof of original purchase date is needed to obtain service under warranty.**

### **WHAT IS COVERED**

#### **LIMITED ONE-YEAR WARRANTY**

For one year from the date of purchase by the original owner, Avanti Products will, at its option, repair or replace any part of the unit, which proves to be defective in material or workmanship under normal use. During this period Avanti Products will provide all parts and labor necessary to correct such defects free of charge, so long as the unit has been installed and operated in accordance with the written instructions in this manual. In rental or commercial use, the warranty period is 90 days. Avanti Products will provide you with a reasonably similar replacement product that is either new or factory refurbished. All Avanti Appliances of 3.5 cubic feet capacity or less must be brought/sent to the appliance service shop for repair.

#### **LIMITED SECOND THROUGH FIFTH YEAR WARRANTY**

For the second through the fifth year from date of original purchase, Avanti Products will provide a replacement compressor free of charge due to a failure. You are responsible for the service labor and freight charges. In rental or commercial use, the limited compressor warranty is one year and nine months. Cost to move the appliance to the servicers' shop and back to the user's home, as may be required, are the user's responsibility.

---

### **WHAT IS NOT COVERED**

- Content losses of food or other, due to spoilage.
- Incidental or consequential damages.
- Parts and labor costs for the following will not be considered as warranty:
  - Door springs, and/or frames.
  - Inner door panels, door rails and/or door supports.
  - Light bulbs and/or plastic housing.
  - Plastic cabinet liners.
  - Punctured evaporator that voids the warranty on the complete sealed system.
  - Shipping and handling costs associated with the replacement of the unit.
- Repairs performed by unauthorized servicers.
- Service calls that do not involve defects in material or workmanship such as customer education, door reversal, or proper installation.
- Service calls that are related to external problems, such as abuse, misuse, inadequate electrical power, accidents, fire, floods, or acts of God.
- Surcharges including, but not limited to, any after hour, weekend, or holiday service calls, tolls, ferry trip charges, or mileage expenses for service calls to remote areas, including the State of Alaska.
- Replacement of house fuses or resetting circuit breakers.
- Failure of the product if it is used for other than its intended purpose.
- This warranty does not apply outside the Continental USA.

## **INSTRUCCIONES DE SEGURIDAD**

### **ATENCION**

#### **INSTRUCCIONES PARA LA CONEXION A TIERRA**

Este aparato electrodoméstico debe estar conectado a tierra. En caso de un cortocircuito eléctrico, la conexión a tierra reduce el riesgo de choque eléctrico proporcionando un cable a tierra con una enchufe de conexión a tierra. Este enchufe debe estar conectado en un tomacorriente instalado correctamente y conectado a tierra.

**ADVERTENCIA** – El uso inadecuado del enchufe de conexión a tierra puede resultar en un riesgo de choque eléctrico. Consulte con un electricista o persona de reparaciones competente si no comprenden bien las instrucciones de conexión a tierra o si existe alguna duda sobre si el aparato esta conectado a tierra correctamente.

#### **NO USE UN CORDON DE PROLONGACION ELECTRICA**

Use un tomacorriente de pared exclusivo. No conecte su vinera a cordones de prolongación eléctrica o junto a cualquier otro electrodoméstico en el mismo tomacorriente de pared.

#### **ADVERTENCIA IMPORTANTE:**

Una vinera vacía es una atracción muy peligrosa para los niños. Saque todas las juntas, pestillos, tapas o puerta de todo electrodoméstico que no esté en uso, o tome alguna medida para asegurar que no presente peligro.

### **INSTRUCCIONES DE INSTALACION**

Saque los embalajes exteriores, limpie bien el exterior con un paño suave seco, y el interior con un paño húmedo y tibio. Evite colocar la vinera cerca de una fuente de calor, luz de sol directa, o lugar húmedo.

### **UBICACION**

1. Seleccione un lugar con su piso fuerte y nivelado.
2. Evite la luz directa del sol o calor. La luz directa del sol puede afectar la capa de acrílico. Las fuentes de calor en su proximidad provocarán un consumo mayor de electricidad.

### **OPERACION**

Para evitar vibraciones, el compartimiento interior debe estar bien nivelado. La temperatura variará dependiendo de la cantidad de botellas almacenadas y la frecuencia con que se abre la puerta.

Cuando la vinera no se use por un período largo, desconecte el enchufe y deje la puerta entreabierta.

Nota: Espere entre 3 a 5 minutos antes de volver a encender si el funcionamiento ha sido interrumpido.

Se recomienda que Ud coloque su vinera en un lugar donde la temperatura ambiental se mantenga entre 23-25 grados centígrados.

Si la temperatura ambiental oscila afuera de esos límites, pueda afectar la temperatura de la caja.

Por ejemplo, si su unidad está situada en lugares donde hay temperaturas muy frías o calientes también puede afectar la temperatura de la caja.



Temperaturas recomendadas para enfriar vinos:

|                          |            |            |
|--------------------------|------------|------------|
| Vinos tintos             | 58 - 65 °F | 15 – 18 °C |
| Vinos blancos / secos    | 48 - 57 °F | 10 – 13 °C |
| Vinos rosé / Zinfandel   | 49 - 51 °F | 9 – 11 °C  |
| Vinos blanco / espumante | 40 - 47 °F | 5 - 8 °C   |

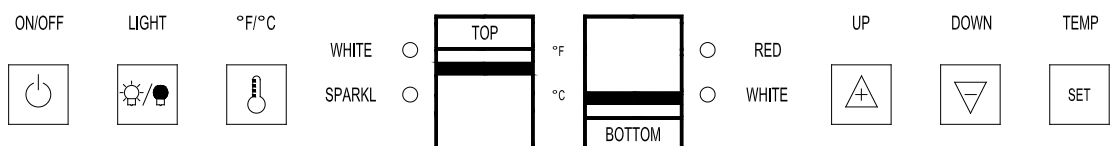





Para encender el electrodoméstico, oprima el botón marcado .



En la fábrica se programa la zona superior a los 50°F (10°C).  
La zona inferior se programa a los 60°F (16°C).

Ud puede cambiar de grados Centígrados a Fahrenheit o viceversa, oprimiendo el botón marcado °F/C . En la pantalla digital para cada zona aparecerán los grados en color azul.

### **OPERACION**

Oprima los botones marcado  y  localizados en el lado derecho del panel de controles para programar la temperatura interna de la zona superior. Repita esa operación pero con los botones localizados en el lado derecho para programar la temperatura interna de la zona inferior. La pantalla mostrará los grados respectivamente para cada zona en color rojo. La temperatura en la zona inferior varía entre 55~65°F (13~18°C) y es la indicada para los vinos rojos o blancos. La temperatura en la zona superior varía entre 40~55°F (5~13°C) y es la indicada para los vinos blancos o espumosos.

Al presionar los botones marcados  o  por primera vez, el indicador en la pantalla mostrará la temperatura programada de fábrica o la más reciente.

Oprima el botón marcado  una vez y la temperatura aumentará un grado. Si Ud oprime el botón marcado  una vez la temperatura bajará un grado.

Si en su mayoría Usted solamente guarda vinos rojos, debe colocarlos en la zona inferior.

El indicador marcado (RED) se alumbrará en color rojo. Ud necesita programar esa temperatura entre los 58~65°F (15~18°C).

Si Ud solamente guarda vinos blancos, usted puede colocarlos en cualquier zona pero tendrá que mantener una temperatura entre 55~57°F (13~14°C) en la zona inferior y una temperatura de 48~55°F (9~13°C) en la zona superior.

El indicador marcado "WHITE" se alumbrará en color verde.

Cuando Ud guarda vinos espumosos, deberá colocar las botellas en la zona superior y marcar la temperatura entre los 40~47°F (5~8°C).

El indicador marcado "SPARKL" se alumbrará en color ámbar.

### **LUZ INTERIOR**

La luz interior para cada zona se controla automáticamente al abrir y cerrar la puerta. Si desea la luz interior encendida aun con la puerta cerrada, oprima el botón marcado () la luz interior encenderá y se apagará automáticamente después de 10 minutos.

## **DESCONGELACION**

Su refrigerador para vinos ha sido diseñado con un sistema de descongelación de “ciclo automático”. Las superficies refrigeradas del compartimiento para vinos se descongela automáticamente, durante el ciclo “apagado” del control de enfriamiento (termostato). El agua descongelada del compartimiento es eliminada automáticamente, encauzándola hacia una bandeja de goteo ubicado en el compresor. La transferencia de calor del compresor evapora el agua.

### **ADVERTENCIA**

Asegúrese de tener la puerta abierta completamente si Ud desea remover los estantes de madera o moverlos hacia adelante para extraer una botella.

### **NOTA:**

Para remover los estantes de madera corredizos, mueva cada uno de ellos aproximadamente una tercera parte fuera de los raíles.

Presione el lado plástico derecho usando un destornillador plano (siga la flecha) como se muestra en el dibujo “A” de la página 11 y a la misma vez haga lo mismo con el plástico del lado izquierdo como se muestra en el dibujo “B” de la página 11.

Saque el estante corredizo suavemente.

## **CUIDADO Y MANTENIMIENTO**

### **LIMPIEZA**

Para limpiar el interior, use un paño suave con una solución de una cucharada de bicarbonato de sodio por cada cuarto de agua, o una solución de espuma de jabón suave, o un detergente suave. Para lavar las rejillas, sáquelas deslizándolas con cuidado, y use una solución de detergente suave; luego séquelas con un paño suave. Limpie el exterior con un paño húmedo suave y un poco de detergente suave o productos de limpieza para electrodomésticos.

### **PERIODO DE VACACIONES**

Para períodos cortos de vacaciones, deje los controles en la posición normal. Durante ausencias más largas;

- (a) saque todas las botellas,
- (b) desconecte la vinera del tomacorriente,
- (c) limpie bien el refrigerador para vinos,
- (d) deje la puerta abierta para evitar la formación de condensación, moho u olores.

### **CORTE DE CORRIENTE**

La mayoría de los cortes de corriente se corrigen en una o dos horas y no afectarán las temperaturas de su vinera. Sin embargo, Ud. deberá reducir la cantidad de veces que abra la puerta cuando la corriente esté apagada.

### **SI UD. SE MUDA**

Saque o asegure todos los artículos dentro de su vinera. Para evitar que los tornillos nivelantes se averíen, gírelos completamente hacia la base.

Algunas reglas importantes para el uso correcto de la vinera.

- Las bebidas se deben guardar en botellas cerradas.
- No sobrecargue el compartimiento interior.
- No abra la puerta a menos que sea necesario.
- Si la vinera se guardara sin uso por períodos largos, se sugiere que, luego de una limpieza cuidadosa, se deje la puerta entreabierta para permitir que el aire circule dentro de la caja y evitar una posible formación de condensación, moho u olores.
- Nunca cubra los estantes del compartimiento para vinos con papel de aluminio o cualquier otro material para cubrir estantes que puedan obstruir la circulación del aire.

## Registration Information

Thank you for purchasing this fine Avanti product. Please fill out this form and return it to the following address within 100 days from the date of purchase and receive these important benefits:

**Avanti Products, A Division of The Mackle Co., Inc.**  
**P.O.Box 520604 – Miami, Florida 33152**

➤ **Protect your product:**

We will keep the model number and date of purchase of your new Avanti product on file to help you refer to this information in the event of an insurance claim such as fire or theft.

➤ **Promote better products:**

We value your input. Your responses will help us develop products designed to best meet your future needs.

------(detach here)-----

---

### Avanti Registration Card

|  |   |                     |
|--|---|---------------------|
| Name   | Model #   | Serial #            |
| Address  | Date Purchased  | Store / Dealer Name |
| City            State            Zip   | E-mail Address  |                     |
| Area Code    Phone Number  | Occupation  |                     |
| Did You Purchase An Additional Warranty  | As your Primary Residence, Do You:  |                     |
| <input type="checkbox"/> Extended<br><input type="checkbox"/> None   | <input type="checkbox"/> Own <input type="checkbox"/> Rent  |                     |
| Reason for Choosing This Avanti Product:<br>Please indicate the most important factors<br>That influenced your decision to purchase<br>this product:   | Your Age:   |                     |
| <input type="checkbox"/> Price<br><input type="checkbox"/> Product Features<br><input type="checkbox"/> Avanti Reputation<br><input type="checkbox"/> Product Quality<br><input type="checkbox"/> Salesperson Recommendation<br><input type="checkbox"/> Other: _____<br><input type="checkbox"/> Friend / Relative Recommendation<br><input type="checkbox"/> Warranty<br><input type="checkbox"/> Other: _____ | <input type="checkbox"/> under 18 <input type="checkbox"/> 18-25 <input type="checkbox"/> 26-30<br><input type="checkbox"/> 31-35 <input type="checkbox"/> 36-50 <input type="checkbox"/> over 50 |                     |
| Comments:  | <u>Marital Status:</u><br><input type="checkbox"/> Married <input type="checkbox"/> Single  |                     |
|  | <u>Is This Product Used In The:</u><br><input type="checkbox"/> Home <input type="checkbox"/> Business  |                     |
|  | <u>How Did You Learn About This Product:</u><br><input type="checkbox"/> Advertising<br><input type="checkbox"/> In-Store Demo<br><input type="checkbox"/> Personal Demo                          |                     |
|  |   |                     |
|  |   |                     |

**VER – WCR5450DZ-02212011**

**PRINTED IN CHINA**