



**CONGRATULATIONS!**

You have just purchased the finest commercial refrigerator available. You can expect many years of trouble-free operation.

**TABLE OF CONTENTS**

**SAFETY INFORMATION**

Safety Precautions \_\_\_\_\_ 1  
Proper Disposal, Connecting Electricity, & Adapter Plugs \_\_\_\_\_ 2

**INSTALLATION**

Ownership & Uncrating \_\_\_\_\_ 3  
Wire Gauge Chart & Electrical Installation \_\_\_\_\_ 3  
Locating and Leveling \_\_\_\_\_ 5  
Installation of Legs or Castors \_\_\_\_\_ 6  
Sealing Cabinet to the Floor \_\_\_\_\_ 8

**SETUP**

Standard Accessories \_\_\_\_\_ 9  
Cabinet Adjustment \_\_\_\_\_ 11

**OPERATION**

Startup \_\_\_\_\_ 13  
Mechanical Temperature Controls Sequence of Operation \_\_\_\_\_ 13  
Electronic Temperature Controls Sequence of Operation \_\_\_\_\_ 19

**MAINTENANCE, CARE, CLEANING**

Cleaning Condenser Coil \_\_\_\_\_ 29  
Important Warranty Information \_\_\_\_\_ 30  
Stainless Steel Equipment Care and Cleaning \_\_\_\_\_ 31  
General Maintenance \_\_\_\_\_ 32

**WARRANTY**

Warranty \_\_\_\_\_ 33



GDM-23



GDM-49



GDM-69



INSTALLATION MANUAL

GDM FREEZER/REFRIGERATOR



## NOTICE TO CUSTOMER

**Loss or spoilage of products in your refrigerator/freezer is not covered by warranty. In addition to following recommended installation procedures you must run the refrigerator/freezer 24 hours prior to usage.**



## SAFETY INFORMATION

How to Maintain Your True Refrigerator to Receive the Most Efficient and Successful Operation.

You have selected one of the finest commercial refrigeration units made. It is manufactured under strict quality controls with only the best quality materials available. Your TRUE cooler when properly maintained will give you many years of trouble-free service.

**WARNING:** Use this appliance for its intended purpose as described in this Owner Manual.

**TO LOCATE REFRIGERANT TYPE, SEE SERIAL LABEL INSIDE CABINET.** This cabinet may contain fluorinated greenhouse gas covered by the Kyoto Protocol (please refer to cabinet's inner label for type and volume, GWP of 134a= 1,300. R404a= 3,800).

### FOR HYDROCARBON REFRIGERATION ONLY (R-290) SEE BELOW:

- **DANGER** - Risk of fire or explosion. Flammable refrigerant used. Do not use mechanical devices to defrost refrigerator. Do not puncture refrigerant tubing.
- **DANGER** - Risk of fire or explosion. Flammable refrigerant used. To be repaired only by trained service personnel. Do not puncture refrigerant tubing.
- **CAUTION** - Risk of fire or explosion. Flammable refrigerant used. Consult repair manual/owner's guide before attempting to service this product. All safety precautions must be followed.
- **CAUTION** - Risk of fire or explosion. Dispose of properly in accordance with federal or local regulations. Flammable refrigerant used.
- **CAUTION** - Risk of fire or explosion due to puncture of refrigerant tubing; follow handling instructions carefully. Flammable refrigerant used.
- **CAUTION** - Keep clear of obstruction all ventilation openings in the appliance enclosure or in the structure for building-in.

## SAFETY PRECAUTIONS

When using electrical appliances, basic safety precautions should be followed, including the following:

- This refrigerator must be properly installed and located in accordance with the Installation Instructions before it is used.
- Do not allow children to climb, stand or hang on the shelves in the refrigerator. They could damage the refrigerator and seriously injure themselves.
- Do not touch the cold surfaces in the freezer compartment when hands are damp or wet. Skin may stick to these extremely cold surfaces.
- Do not store or use gasoline or other flammable vapors and liquids in the vicinity of this or any other appliance. Do not store explosive substances such as aerosol cans with a flammable propellant in this appliance.

- Keep fingers out of the "pinch point" areas; clearances between the doors and between the doors and cabinet are necessarily small; be careful closing doors when children are in the area.
- Unplug the refrigerator before cleaning and making repairs.
- Setting temperature controls to the 0 position does not remove power to the light circuit, perimeter heaters, or evaporator fans.

**NOTE:** We strongly recommend that any servicing be preformed by a qualified technician.

## DANGER!

# RISK OF CHILD ENTRAPMENT

### PROPER DISPOSAL OF THE REFRIGERATOR

Child entrapment and suffocation are not problems of the past. Junked or abandoned refrigerators are still dangerous... even if they will sit for "just a few days." If you are getting rid of your old refrigerator, please follow the instructions below to help prevent accidents.

#### BEFORE YOU THROW AWAY YOUR OLD REFRIGERATOR OR FREEZER:

- Take off the doors.
- Leave the shelves in place so that children may not easily climb inside.

### APPLIANCE DISPOSAL

When recycling appliance please make sure that the refrigerants are handled according to local and national codes, requirements and regulations.

### REFRIGERANT DISPOSAL

Your old refrigerator may have a cooling system that uses "Ozone Depleting" chemicals. If you are throwing away your old refrigerator, make sure the refrigerant is removed for proper disposal by a qualified service technician. If you intentionally release any refrigerants you can be subject to fines and imprisonment under provisions of the environmental regulations.

### USE OF EXTENSION CORDS

**NEVER USE AN EXTENSION CORD!** TRUE will not warranty any refrigerator that has been connected to an extension cord.

### REPLACEMENT PARTS

- Component parts shall be replaced with like components.
- Servicing shall be done by authorized service personnel, to minimize the risk of possible ignition due to incorrect parts or improper service.
- Lamps must be replaced by identical lamps only.
- If the supply cord is damaged, it must be replaced by a special cord or assembly available from the manufacturer or its service agent.

## WARNING!

### HOW TO CONNECT ELECTRICITY

**DO NOT, UNDER ANY CIRCUMSTANCES, CUT OR REMOVE THE GROUND PRONG FROM THE POWER CORD. FOR PERSONAL SAFETY, THIS APPLIANCE MUST BE PROPERLY GROUNDED.**

The power cord from this appliance is equipped with a grounding plug which minimizes the possibility of electric shock hazard.

Have the wall outlet and circuit checked by a qualified electrician to make sure the outlet is properly grounded.

If the outlet is a standard 2-prong outlet, it is your personal responsibility and obligation to have it replaced with the properly grounded wall outlet.

The refrigerator should always be plugged into its own individual electrical circuit, which has a voltage rating that matches the rating plate.

This provides the best performance and also prevents overloading building wiring circuits which could cause a fire hazard from overheated wires.

Never unplug your refrigerator by pulling on the power cord. Always grip plug firmly and pull straight out from the outlet.

Repair or replace immediately all power cords that have become frayed or otherwise damaged. Do not use a cord that shows cracks or abrasion damage along its length or at either end.

When removing the refrigerator away from the wall, be careful not to roll over or damage the power cord.

If supply power cord is damaged it should be replaced with original equipment manufacture parts. To avoid hazard this should be done by a qualified service technician.

### USE OF ADAPTER PLUGS

**NEVER USE AN ADAPTER PLUG!** Because of potential safety hazards under certain conditions, we strongly recommend against the use of an adapter plug.

The incoming power source to the cabinet including any adapters used must have the adequate power available and must be properly grounded. Only adapters listed with UL should be used.

### NORTH AMERICA USE ONLY!

NEMA plugs

TRUE uses these types of plugs. If you do not have the right outlet have a certified electrician install the correct power source.

**NOTE:** International plug configurations vary by voltage and country.



# INSTALLATION

## OWNERSHIP

To ensure that your unit works properly from the first day, it must be installed properly. We highly recommend a trained refrigeration mechanic and electrician install your TRUE equipment. The cost of a professional installation is money well spent.

Before you start to install your TRUE unit, carefully inspect it for freight damage. If damage is discovered, immediately file a claim with the delivery freight carrier.

TRUE is not responsible for damage incurred during shipment.

## UNCRATING

### TOOLS REQUIRED

- Adjustable Wrench
- Phillips Screwdriver
- Level

The following procedure is recommended for uncrating the unit:

- Remove the outer packaging, (cardboard and bubbles or styrofoam corners and clear plastic). Inspect for concealed damage. Again, immediately file a claim with the freight carrier if there is damage.
- Move your unit as close to the final location as possible before removing the wooden skid.
- Remove door bracket on swinging glass door models (see image 1-2). Do not throw the bracket or blocks away. For future cabinet movement the bracket and blocks will need to be installed so the glass door does not receive any damage. (See image for bracket and shipping block removal)

**NOTE: KEYS FOR COOLERS WITH DOOR LOCKS ARE LOCATED IN WARRANTY PACKETS.**

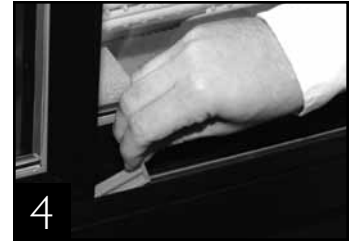

## ELECTRIC INSTALLATION & SAFETY INFORMATION

- If the supply cord is damaged, it must be replaced by a special cord or assembly available from the manufacturer or its service agent.
- Lamps must be replaced by identical lamps only.
- Appliance tested according to the climate classes 5 and 7 temperature and relative humidity.

### ELECTRICAL INSTRUCTIONS

- Before your new unit is connected to a power supply, check the incoming voltage with a voltmeter. If anything less than 100% of the rated voltage for operation is noted, correct immediately.
- All units are equipped with a service cord, and must be powered at proper operating voltage at all times. Refer to cabinet data plate for this voltage.

**TRUE RECOMMENDS THAT A SOLE USE CIRCUIT BE DEDICATED FOR THE UNIT.**

**WARNING:** Compressor warranties are void if compressor burns out due to low voltage.

**WARNING:** Power supply cord ground should not be removed!

**WARNING:** Do not use electrical appliances inside the food storage compartments of the appliances unless they are of the type recommended by the manufacturer.

**NOTE:** To reference wiring diagram, remove front louvered grill, wiring diagram is positioned on the inside cabinet wall.

## WIRE GAUGE CHART

115 Volts Amps	Distance In Feet To Center of Load											
	20	30	40	50	60	70	80	90	100	120	140	160
2	14	14	14	14	14	14	14	14	14	14	14	14
3	14	14	14	14	14	14	14	14	14	14	14	12
4	14	14	14	14	14	14	14	14	14	12	12	12
5	14	14	14	14	14	14	14	12	12	12	10	10
6	14	14	14	14	14	14	12	12	12	10	10	10
7	14	14	14	14	14	12	12	12	10	10	10	8
8	14	14	14	14	12	12	12	10	10	10	8	8
9	14	14	14	12	12	12	10	10	10	8	8	8
10	14	14	14	12	12	10	10	10	10	8	8	8
12	14	14	12	12	10	10	10	8	8	8	8	6
14	14	14	12	10	10	10	8	8	8	6	6	6
16	14	12	12	10	10	8	8	8	8	6	6	6
18	14	12	10	10	8	8	8	8	8	8	8	5
20	14	12	10	10	8	8	8	6	6	6	5	5
25	12	10	10	8	8	6	6	6	6	5	4	4
30	12	10	8	8	6	6	6	6	5	4	4	3
35	10	10	8	6	6	6	5	5	4	4	3	2
40	10	8	8	6	6	5	5	4	4	3	2	2
45	10	8	6	6	6	5	4	4	3	3	2	1
50	10	8	6	6	5	4	4	3	3	2	1	1

230 Volts Amps	Distance In Feet To Center of Load											
	20	30	40	50	60	70	80	90	100	120	140	160
5	14	14	14	14	14	14	14	14	14	14	14	14
6	14	14	14	14	14	14	14	14	14	14	14	12
7	14	14	14	14	14	14	14	14	14	14	12	12
8	14	14	14	14	14	14	14	14	14	14	12	12
9	14	14	14	14	14	14	14	14	14	12	12	10
10	14	14	14	14	14	14	14	14	12	12	10	10
12	14	14	14	14	14	12	12	12	10	10	10	8
14	14	14	14	14	14	12	12	12	10	10	10	8
16	14	14	14	14	12	12	12	10	10	10	8	8
18	14	14	14	12	12	12	10	10	10	8	8	8
20	14	14	14	12	10	10	10	10	10	8	8	8
25	14	14	12	12	10	10	10	10	10	8	8	6
30	14	12	12	10	10	10	8	8	8	6	6	6
35	14	12	10	10	10	8	8	8	8	6	6	5
40	14	12	10	10	8	8	8	6	6	6	5	5
50	12	10	10	8	6	6	6	6	6	5	4	4
60	12	10	8	6	6	6	6	6	6	5	4	3
70	10	10	8	6	6	6	5	5	4	4	2	2
80	10	8	8	6	6	5	5	4	4	3	2	2
90	10	8	6	6	5	5	4	4	3	3	1	1
100	10	8	6	6	5	4	4	3	3	2	1	1

## LOCATING

- Remove louver from the front of cabinet (see page 19 for louver grill removal / reinstallation) and backguard (if applicable) from rear of cabinet.
- Skid bolts are located in each of 4 corners inside cabinet bottom. (See photo A).
- Remove skid bolts. (See photo B).
- Cut straps if applicable. (See photo C).
- Carefully lift cabinet off of skid.
- Appliance tested according to the climate classes 5 and 7 for temperature and relative humidity.

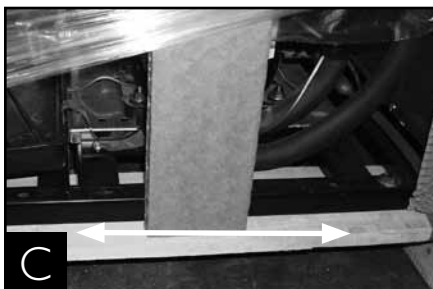
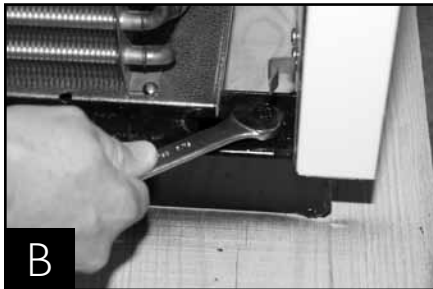

When moving cabinet **DO NOT** push on door hinges.

## LEVELING

- Set unit in its final location. Be sure there is adequate ventilation in your room. Under extreme heat conditions, (100°F+, 38°C+), you may want to install an exhaust fan.

### **WARNING: WARRANTY IS VOID IF VENTILATION IS INSUFFICIENT.**

- Proper leveling of your TRUE cooler is critical to operating success (for non-mobile models). Effective condensate removal and door operation will be effected by leveling.
- The cooler should be leveled front to back and side to side with a level.
- Ensure that the drain hose or hoses are positioned in the pan.
- Free plug and cord from inside the lower rear of the cooler (do not plug in).
- The unit should be placed close enough to the electrical supply so that extension cords are never used.

### **WARNING: CABINET WARRANTIES ARE VOID IF OEM POWER CORD IS TAMPERED WITH. TRUE WILL NOT WARRANTY ANY UNITS THAT ARE CONNECTED TO AN EXTENSION CORD.**

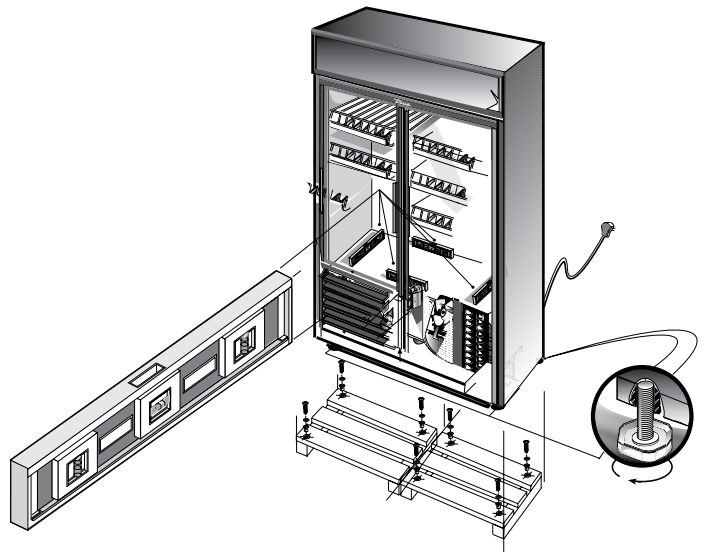

## INSTALLATION OF CASTORS OR OPTIONAL LEGS

Important Safeguard for installation of leg/castor: Images 1-5 demonstrate procedure.

### SECURING CASTORS AND LEGS

To obtain maximum strength and stability of the unit, it is important that you make sure each castor is secure. Optional legs are hand-tightened securely against the lower rail assembly see image 4-5. The bearing race on the castor or the top edge of the leg must make firm contact with the rail.

### LEVELING SHIMS

Four leveling shims have been provided for leveling castored units positioned on uneven floors. Shims must be positioned between rail end and bearing race.

- A. Turn the bearing race counter-clockwise until the cabinet is level. Level front to back and side to side. (diagonally)
- B. Install the desired number of shims, making sure the slot of the shim is in contact with the threaded stem of the castor. See image 2.
- C. If more than one shim is used, turn the slot at a 90° angle so they are not in line.
- D. Turn the bearing race clockwise to tighten and secure the castor by tightening the anchoring bolt with a 3/4 inch open-end wrench or the tool provided. See image 3.

**CAUTION: TO AVOID DAMAGE TO LOWER RAIL ASSEMBLY, SLOWLY RAISE UNIT TO UPRIGHT POSITION.**

**NOTE: OPEN HOLES LOCATED ON THE CROSS MEMBERS OF THE FRAME RAIL SHOULD BE PLUGGED BEFORE UNIT IS IN USE.**



1 Thread castor into the underside of cabinet frame rail.



2 For leveling, insert the shim between castor and frame rail.



3 Use the tool provided to tighten the castor into place.



4 Thread leg into cabinet bottom frame rail.



5 The end of the leg is adjustable for easy leveling.

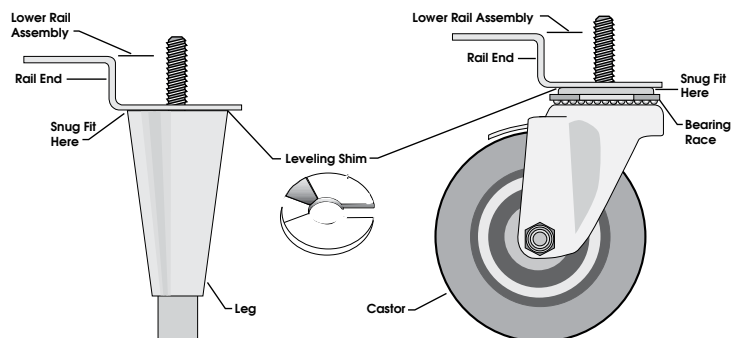

## INSTALLING OPTIONAL CASTORS ON GDM-10 AND GDM-12 MODELS

### FINAL LOCATION

- A. Place Styrofoam corners behind cooler for cushion and carefully tilt unit on it's back.
- B. Remove the louvered grill by removing four phillips-head screws.
- C. Remove the four bolts from the skid with an adjustable wrench, and locate the four castors. Castors are placed inside cooler, within the bubble wrap.
- D. Install one castor in each of the four female threaded areas as indicated.

**NOTE:** Two out of the four castors are designated with an "F" for front. These are provided with hand-brakes. Position these castors in FRONT of the unit.

- E. When all castors have been threaded fully, replace grill and lift unit; positioning it into its final location.
- F. Ensure that the two front castors are positioned FORWARD as illustrated and locked down with the hand-brakes.

**WARNING:** Unit may tip forward if procedure "F" is not strictly followed.

- G. Units final location should be adequately ventilated. Conditions where heat exceeds 100°F require an exhaust fan.
- H. Ensure that the drain hose for hoses are positioned in the pan.
- I. Free plug and cord from inside the lower rear of the cooler (Do Not Plug In.)

**WARNING:** Warranty is VOID if ventilation is insufficient.

- J. The unit should be placed close enough to the electrical supply so that extension cords are NEVER used.

**WARNING:** Cabinet warranties are void if OEM power cord is tampered with. TRUE will not warranty any units that are connected to an extension cord.

- K. Proper leveling of your TRUE cooler is critical to operating success. Effective condensate removal and door operation will be effected by leveling. Adjust castors or add shims.

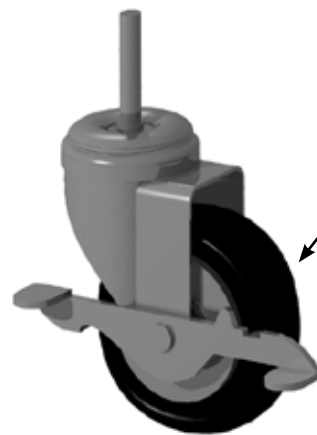

POSITIONING OF THE  
CASTOR IS CRITICAL.  
ORIENT THE CASTOR IN  
THE FORWARD POSITION  
AS SHOWN.



## SEALING CABINET TO FLOOR

**STEP 1** - Position Cabinet - Allow one inch between the wall and rear of the GDM refrigerator to assure proper ventilation. For GDM freezers 3 inches between the wall and rear of the cabinet will assure proper ventilation.

**STEP 2** - Level Cabinet - Cabinet should be level, side to side and front to back. Place a carpenter's level in the interior floor in four places:

- A. Position level in the inside floor of the unit near the doors. (Level should be parallel to cabinet front). Level cabinet.
- B. Position level at the inside rear of cabinet. (Again level should be placed parallel to cabinet back).
- C. Perform similar procedures to steps A & B by placing the level on inside floor (left and right sides - parallel to the depth of the cooler). Level cabinet.

**STEP 3** - Draw an outline on the base on the floor.

**STEP 4** - Raise and block the front side of the cabinet.

**STEP 5** - Apply a bead of "NSF Approved Sealant", (see list below), to floor on half inch inside the outline drawn. The bead must be heavy enough to seal the entire cabinet surface when it is down on the sealant.

**STEP 6** - Raise and block the rear of the cabinet

**STEP 7** - Apply sealant on floor as outlined in Step 5 on other three sides.

**STEP 8** - Examine to see that cabinet is sealed to floor around entire perimeter.

**NOTE:** Asphalt floors are very susceptible to chemical attack. A layer of tape on the floor prior to applying the sealant will protect the floor.

### NSF APPROVED SEALANTS:

1. Minnesota Mining #ECU800 Caulk
2. Minnesota Mining #ECU2185 Caulk
3. Minnesota Mining #ECU1055 Bead
4. Minnesota Mining #ECU1202 Bead
5. Armstrong Cork - Rubber Caulk
6. Products Research Co. #5000 Rubber Caulk
7. G.E. Silicone Sealer
8. Dow Corning Silicone Sealer

# SETUP

## STANDARD ACCESSORIES

### SHELVING INSTALLATION / OPERATION

#### SHELF INSTALLATION:

- Hook shelf clips onto shelf standards.
- Position all four shelf clips equal in distance from the floor for flat shelves.
- Lower front of gravity feed TrueTrac organizers to enable proper feed.
- Place shelves on shelf clips making sure all corners are seated properly.

**WIRE SHELVES:** Wire shelves are oriented so that cross support bars are facing down.

**NOTE:** GDM-5 models include an airflow guard on the rear of shelves to maintain an air space at the rear of the cabinet. (see illustration).

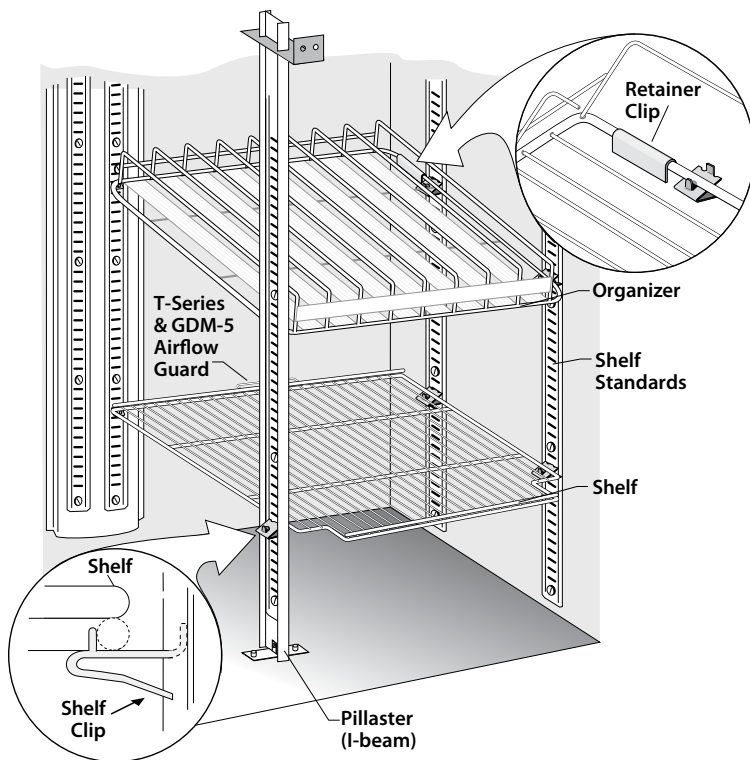

**TRUETRAC ORGANIZERS:** TrueTrac organizers for Glass Door Merchandisers come with a package of shelf retainer clips. Install clip on the side to the rear of organizer (see illustration) to end of organizer that rests against left or right outside wall.

With correct installation, the retainer clip should separate the rear of the organizer from the rear interior wall of the cabinet.

**NOTE:** No retainer clips needed on center organizers of a GDM-69.

### G4SM-23RGS SHELF BRACKET ASSEMBLY

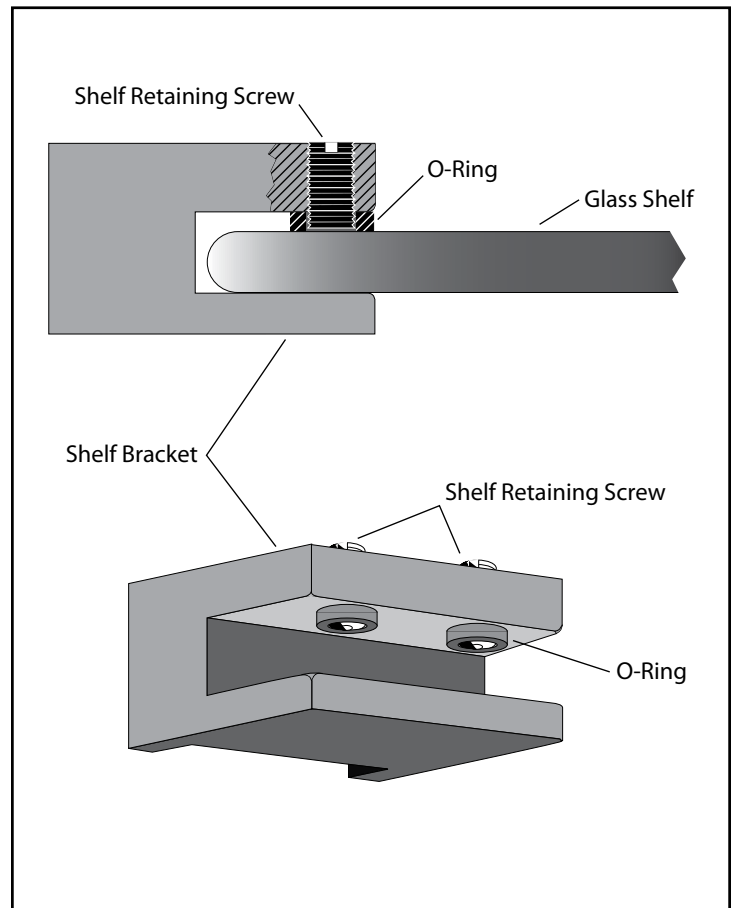

**WARNING!**

Do not use pliers or any crimping tools when installing shelf clips. Altering shelf clips in any way can lead to shelving instability.

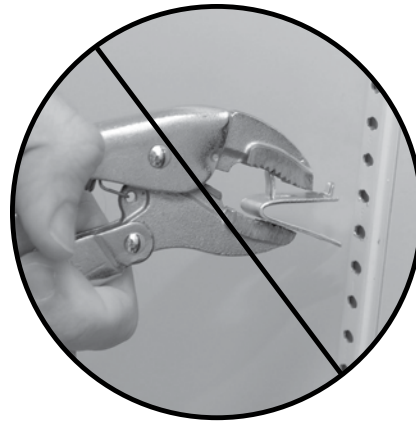

**SHELF INSTALLATION:**

For Proper Shelf Clip Installation Please Read The Following Instructions.

**STEP 1**

Install the top tab of the shelf clip into the proper hole. Push up on the bottom of the clip. (See image 1).

**STEP 2**

Bottom tab of the shelf clip will fit tightly. You may need to squeeze or twist the bottom of the shelf clip to install. (See image 2 & 3).

**STEP 3**

After installation, the shelf clip will fit snug into the shelf standard. The shelf clip should not be loose or able to wiggle out of the shelf standard.

**SHELF INSTALLATION TIPS**

1. Install all the shelf clips before installing the shelves.
2. Start at the bottom in terms of shelf installation and work your way up.
3. Always lay the back of each shelf down on the rear clips before the front.

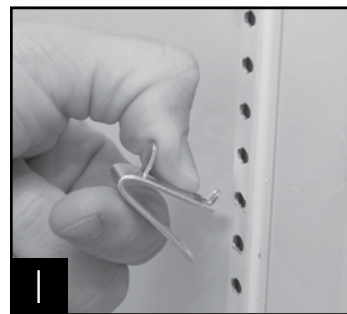

1 Installing top tab of shelf clip

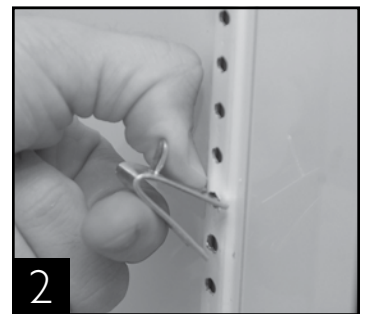

2 Installing bottom of the shelf clip

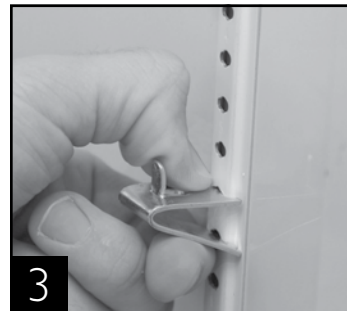

3 You may need to squeeze or twist the bottom of the shelf clip to install



4 Shelf clip installation complete



**INSTALLING SHELVES  
(GDM-30 ONLY)**

Tape door handles back to the cabinet when installing shelves

## SLIDE DOOR OPERATION (CABINET ADJUSTMENT)

**STEP 1** - Before removing slide door do not use the side latch. Tension on the door cord is needed to execute these operation instructions. Doors can not be removed unless placed in specific locations stated in these instructions.

### STEP 2

**Two Door Units:** Slide the front door so it is centered on the cabinet. The door can not be removed unless it is centered. See image 1 for door channel openings and image 2 for centering door.

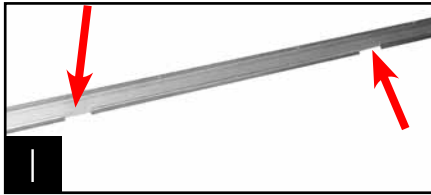

(Two Door Units ONLY)



(Two Door Units ONLY)

**Three Door Units:** Slide the middle door to the right so it is centered with the left edge of the right door. See image 3.



(Three Door Units ONLY)

**STEP 3** - After centering the door lift it up and tilt top of door towards the back of the unit so the rollers are out of the top channel. Swing the bottom of the door out of the bottom channel. Then remove the door and set it down. See image 4.



(TWO DOOR UNITS SKIP TO STEP 6)

**STEP 4** - Slide right door to the left so left edge lines up with the left edge of TRUE Logo located above the door. See image 5. Then lift door out of track same way as image 4.

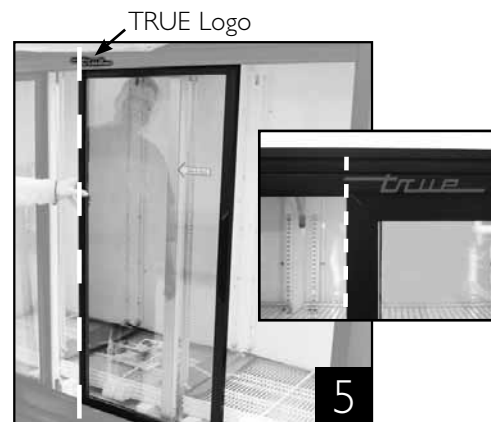

(Three Door Units ONLY)

**STEP 5** - Slide left door to the right so right edge lines up with the end of the TRUE Logo located at the top of the door frame. See image 6. Then lift door out of track same way as image 4.

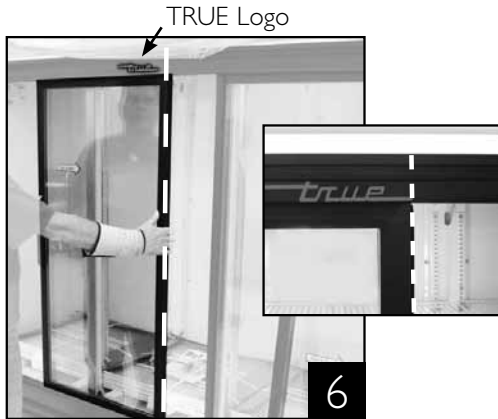

(Three Door Units ONLY)

### TO ADJUST SLIDE DOOR

**STEP 1** - After cabinet is installed in a final location and correctly leveled check for any openings when the slide doors are completely closed. If there are any gaps/openings between the closed doors and cabinet, the doors will need to be adjusted.

**STEP 2** - Using a 7/16" wrench or adjustable wrench and 1/8" Allen wrench loosen roller and move along slotted hole. After adjustment has been made tighten the roller into place. See image 10.



**NOTE:** Door cord will either be nylon cord or metal cable.

**STEP 6** - Remove door cord from roller bracket. The black plastic tab holding the door cord slides out the back. See images 7 & 8.



Door roller bracket with metal cable.



Door roller bracket with nylon cord.

**STEP 7** - Let the door cord slowly retract back into the door side channel.

**STEP 8** - When reinstalling door, make sure door cord grommet attaches to roller slot closest to pulley. See image 9.



Door closing to the left

### SLIDE DOOR UNITS WITH HOLD OPEN FEATURE

These instructions explain how to keep door in open position.

- A. Slide the door open.
- B. Latch the door in the open position from the back side of door (notch in track).
- C. Door latch in image 1 is in the open position.
- D. Door latch in image 2 is in the closed position.



Rear view of door & track

## OPERATION

### STARTUP

- A. The compressor is ready to operate. Plug in the cooler.
- B. Temperature controls are factory-set to give refrigerators an approximate temperature of 35°F (1.7°C) and freezers an approximate temperature of -10°F (-23.3°C). Allow unit to function several hours, completely cooling cabinet before changing the control setting.  
Temperature Control Location and Settings.
  - Electronic temperature control is located on rear of unit or behind access grill.
  - LAE temperature control is located on the front of cabinet countertop or in/behind louvered grill.
  - Mechanical temperature control is located inside of unit.

See website for adjustments, sequence of operation, and more information.
- C. Excessive tampering with the control could lead to service difficulties. Should it ever become necessary to replace temperature control, be sure it is ordered from your TRUE dealer or recommended service agent.
- D. Good air flow in your TRUE unit is critical. Be careful to load product so that it neither presses against the back wall, nor comes within four inches of the evaporator housing. Refrigerated air off the coil must circulate down the back wall.

**NOTE:** If the unit is disconnected or shut off, wait five minutes before starting again.

**RECOMMENDATION** - Before loading product we recommend you run your TRUE unit empty for two to three days. This allows you to be sure electrical wiring and installation are correct and no shipping damage has occurred. Remember, our factory warranty does not cover product loss!

**LIGHT SWITCH LOCATION:** Light switch location depends upon the GDM model. Most GDM models will have the light switch located on the right side of the ceiling inside the unit. Most instances the switch is located next to the temperature control. GDM-49's and 72's have the switch located on the right side of the evaporator housing along the interior ceiling. GDM-9's, 5's, and GDM-5PT's have the switch located on the left side of the ceiling. Some convenience store GDM's have the switch located behind the sliding doors above the light bulb for example the GDM-33SSL-54 and the GDM-33CPT-54. G4SM-23 models have an additional switch for the rotating display shelves. The switch for the rotating shelves in the G4SM-23 models is located under the sign frame.

## MECHANICAL TEMPERATURE CONTROLS

### COIL SENSING

An evaporator coil sensing temperature control ensures that the evaporator coil will remain clear of frost and ice by not allowing the compressor to restart until the coil temperature is above the freezing temperature. This is considered an **off cycle defrost**.



### AIR SENSING

An air sensing temperature control used in a freezer application will require a defrost cycle with heaters to ensure that the evaporator coil is kept clear of frost and ice.



## MECHANICAL TEMPERATURE CONTROL GENERAL SEQUENCE OF OPERATION

### MECHANICAL CONTROL REFRIGERATOR GENERAL SEQUENCE OF OPERATION

1. Cabinet is plugged in.
  - a. Interior lights will illuminate on Glass Door Models only. If lights do not come on verify the light switch is in the "ON" position. Solid door cabinets may or may not have lights that may be controlled by the door switch.
2. The compressor and evaporator fans will start if the temperature control is calling for cooling. (If the compressor does not start, verify that the temperature control is not in the "OFF" or "0" position.)
3. The temperature control may cycle the compressor and evaporator fan(s) on and off together:
  - a. The temperature control is sensing the evaporator coil temperature.
  - b. The temperature control should be set on the #4 or #5.
  - c. The warmest setting is #1, the coldest is #9, and #0 is the off position.
  - d. The thermometer is designed to read and display a cabinet temperature not a product temperature. The thermometer may reflect the refrigeration cycle swings of up and down temperatures. The most accurate temperature on a cabinet's operation is to verify the product temperature.
4. There is not a defrost timer as the temperature control will initiate the off-cycle defrost during each refrigeration cycle.
  - a. At this time, the compressor will and the evaporator fan(s) may turn off. Defrost heaters are not installed on refrigerators and therefore will not be energized.
  - b. After the evaporator coil temperature has been reached, as determined by the temperature control, the compressor will restart.
5. There may be a timer located on the condensing unit base. This timer is not used for a defrost event. The timer will change the rotation of the reversing condenser fan motor.

### MECHANICAL CONTROL FREEZER GENERAL SEQUENCE OF OPERATION

1. Cabinet is plugged in.
  - a. Interior lights will illuminate on glass door models only. If lights do not come on, verify the light switch is in the "ON" position. Solid door cabinets may or may not have lights that may be controlled by the door switch.
2. The compressor only will start if the temperature control is calling for cooling. (If the compressor does not start, verify that the temperature control is not in the "OFF" or "0" position or the cabinet is not in a defrost event.)
  - a. The evaporator fan(s) will remain off until a specific temperature of the evaporator coil is reached.
3. The temperature control may cycle the compressor and evaporator fan(s) on and off together:
  - a. The temperature control is sensing the air temperature.
  - b. The temperature control should be set on the #4 or #5.
  - c. The warmest setting is #1, the coldest is #9, and #0 is the off position.
  - d. The thermometer is designed to read and display a cabinet temperature not a product temperature. The thermometer may reflect the refrigeration cycle swings of up and down temperatures. The most accurate temperature on a cabinet's operation is to verify the product temperature.
4. The defrost timer will initiate defrost during specific times of day.
  - a. At this time, the compressor and evaporator fan(s) will turn off and the evaporator coil heater and drain tube heater will be energized. Some cabinets may also change the rotation of the reversing condenser fan motor.
  - b. After the predetermined evaporator coil temperature has been reached or duration for defrost has expired, the compressor will restart and the evaporator fan(s) will remain off until a specific temperature of the evaporator coil is reached.

## WHEN TO MAKE AN ADJUSTMENT TO A MECHANICAL TEMPERATURE CONTROL

We advise to make a mechanical temperature control adjustment only for a high altitude location.



## HOW TO ADJUST A MECHANICAL TEMPERATURE CONTROL

### OPERATION INSTRUCTIONS:

#### REQUIRED TOOLS:

- Jewelers Screw Driver (Small Screw Driver)

### GE CONTROL INSTRUCTIONS:

The scale to the right may be used as a guide for measuring degrees of rotation required for altitude correction. See Figure 1. The arrows indicate direction of screw rotation. Turn calibration screw clockwise to obtain warmer operating temperatures.

**NOTE:** Each 1/4 turn of the calibration screw is equal to approximately 2 degrees F. Do not make more than 3/4 turn. After making adjustment, measure temperature during three cycles before adjusting again.

**NOTE:** Only adjust the screw (small flathead) on the face of the control (next to the cam). See Figure 3. Follow the Altitude Correction Table to the right.

ALTITUDE CORRECTION TABLE: CALIBRATION SCREW ADJUSTS BOTH CUT-IN AND CUT-OUT	
Altitude (Feet)	Clockwise Turns
2000	7/60
3000	1 1/60
4000	15/60
5000	19/60
6000	23/60
7000	27/60
8000	30/60
9000	34/60
10,000	37/60

Scale Guide for Measuring

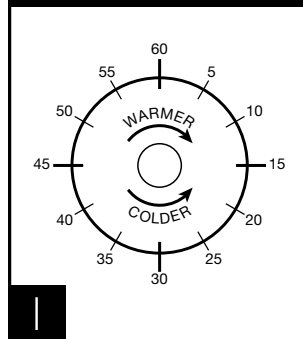

Back of Temperature Control

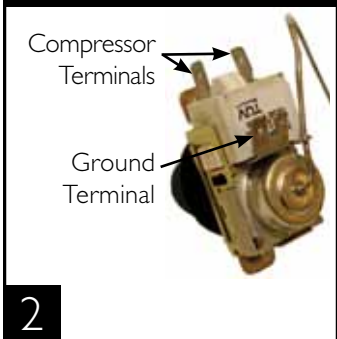

Altitude Correction

Front of Temperature Control

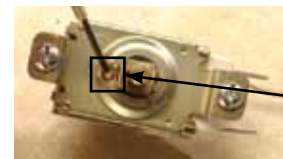

Calibration Screw

To adjust the temperature control take the control knob off to view the cut-in screw. (See Photo Above)

### INSTALLATION INSTRUCTIONS

#### DANFOSS TEMPERATURE CONTROL ADJUSTMENT FOR HIGH ALTITUDE APPLICATIONS:

#### REQUIRED TOOLS:

- Allen Wrench (5/64")
- Torx Screw (T-7)

#### TERMS:

**Cut-out** - Temperature sensed by the controller that shuts the compressor off.

**Cut-in** - Temperature sensed by the controller that turns the compressor on.

Bottom of Temperature Control

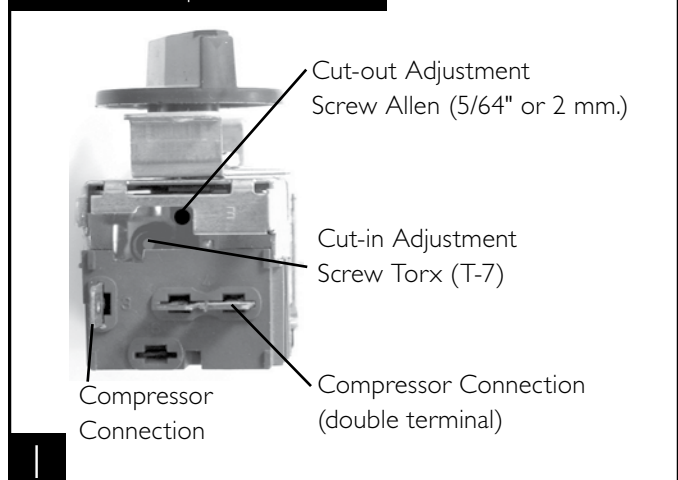



### INSTRUCTIONS: DANFOSS TEMPERATURE CONTROL ADJUSTMENT FOR HIGH ALTITUDE APPLICATIONS

**STEP 1** - Unplug cooler.

**STEP 2** - Remove the screws that secure the temperature control to the inset box.

**STEP 3** - To make these adjustments it may be necessary to remove the temperature control from the housing.

**NOTE:** You may have to remove the wires attached to the control. Take note as to which wire is on which spade terminal.

**STEP 4** - Pull out gently from cabinet.

**NOTE:** Mechanical temperature controllers are affected when functioning at high altitude. The cut-in and cut-out temperatures will be colder than when the controller functions closer to sea level.

**STEP 5** - For high elevation installations, it may be necessary to “warm-up” the set points. To make the adjustment, insert the appropriate tool in each adjustment screw and turn 1/4 of a revolution clockwise (to the right). This procedure will adjust both the cut-in and cut-out about 2°F warmer.

**STEP 6** - Make sure to reconnect the wires to the proper spade terminal when reinstalling.

### INSTALLATION INSTRUCTIONS TEMPERATURE CONTROL ALTITUDE ADJUSTMENT:

#### REQUIRED TOOLS:

- Allen Wrench (5/64")
- Torx Screw (T-7)

The scale to the right may be used as a guide for measuring degrees of rotation required for altitude correction. The arrows indicate direction of screw rotation. See Figure 1.

**IMPORTANT:** Upright models ordered with “High Altitude” temperature controls are pre-calibrated and do not require adjustment.

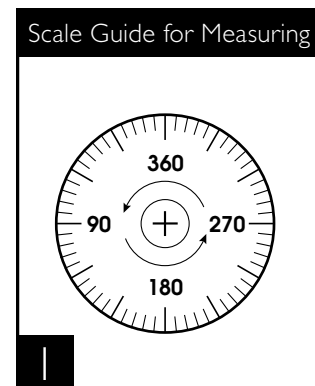

### INSTRUCTIONS: CUTLER HAMMER TEMPERATURE CONTROL ALTITUDE ADJUSTMENT

**STEP 1** - Unplug cooler.

**STEP 2** - Turn the temperature control to the “9” position.

**STEP 3** - Remove the screws that secure the mounting plate to the evaporator top. See Figure 2.

**STEP 4** - Pull control down gently from housing.

**STEP 5** - Turn screws counterclockwise (CCW).

**STEP 6** - Reassemble to cooler housing and return the temperature control to the “5” position.

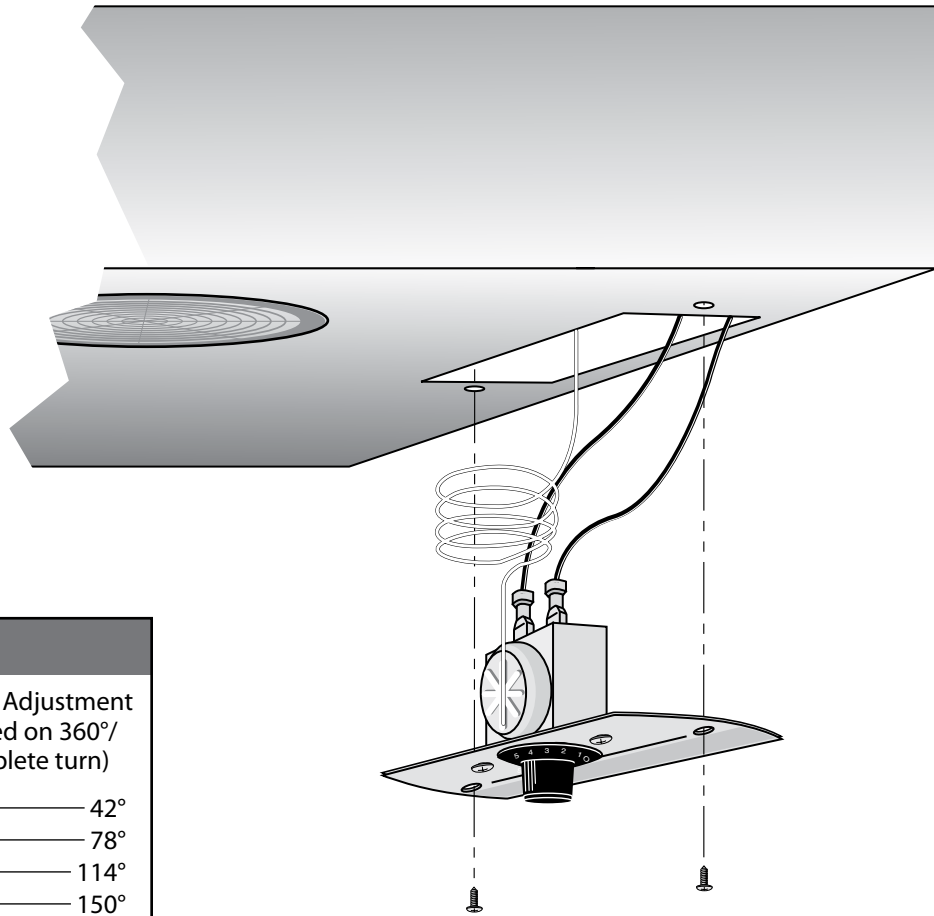

### CHART

Height	CCW Adjustment (based on 360°/ complete turn)
2000'	42°
3000'	78°
4000'	114°
5000'	150°
6000'	186°
7000'	222°
8000'	258°
9000'	294°
10,000'	330°

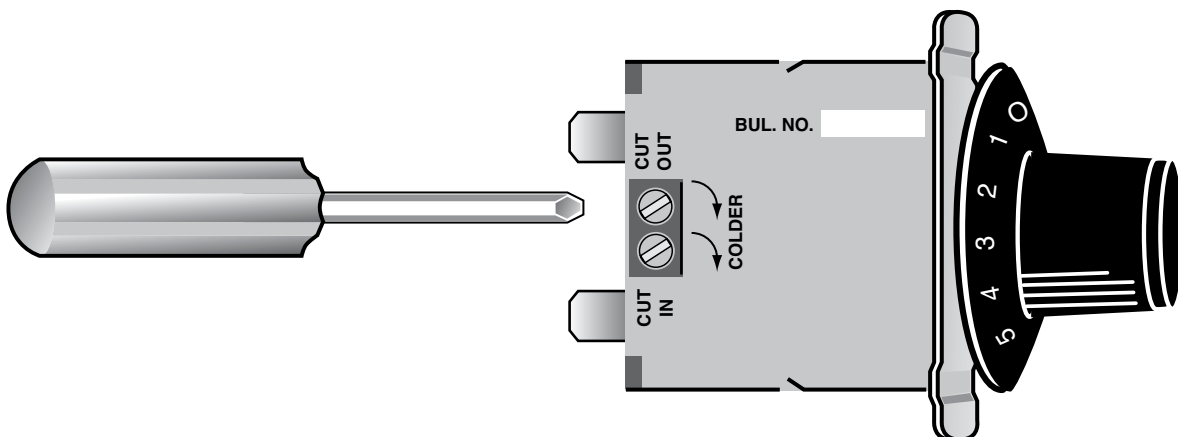

## DEFROST TIMER

### DEFROST TIME CLOCK OPERATION FOR UNITS WITH MECHANICAL CONTROL

#### RECOMMENDED DEFROST SETTINGS:

TRUE Manufacturing has factory set your defrost time clock to a recommended time and duration defrost scenario. All refrigeration equipment operating below 30°F will accumulate frost on the evaporator coil and will require routine defrost. Your TRUE equipment has been designed for three defrost periods (6:00 a.m., 2:00 p.m. and 10:00 p.m.). If you decide to deviate from these defrost time settings please follow the procedures for adjustment below.

#### TOOLS REQUIRED

- Phillips Head Screwdriver
- 1/4" Nut Driver or Socket

#### SETTING THE TIMER:

UNPLUG UNIT FROM POWER SUPPLY! DO NOT SET THE TIME BY ROTATING THE "OUTER" DIAL.

Turn the minute hand clockwise until the time of day on the outer dial is aligned with the triangle marker on the inner dial (two o'clock position).

#### ADJUSTING THE DEFROST TIMER:

Your TRUE freezer contains a defrost system that is temperature terminated, however the time clock has been designed with a time termination back-up so that the defrost period will not exceed thirty minutes. While TRUE requires a minimum 3 defrost periods not to exceed 30 minutes the procedure on this page should be followed to customize your specific needs.

**NOTICE:** If timer is not set for a minimum of 3 defrost per day for 30 minutes each, the coil may develop excessive frost. This may lead to system failure and product loss, which is not covered under warranty.

The following procedure may be followed to customize your needs.

High usage, high temperature, and high humidity may require 4 defrost settings per day.

**WARNING:** Always follow the manufacturer's recommended settings when programming the amount and duration of the defrost cycles.

**STEP 1:** The white tabs located on the outmost area of the time clock have been factory set for (6:00 a.m., 2:00 p.m., and 10:00 p.m.). Each tab represents 15 minutes of defrost time. Notice that at each defrost time two white tabs are set for 15 minutes each for a total of 30 minutes of defrost.

**STEP 2:** In order to program the time to begin the defrost cycle, flip the white tabs out to set the defrost time. To eliminate a defrost time flip the white tabs back toward the center of the Defrost Timer.

**STEP 3:** TRUE recommends a 30 minute defrost cycle three times per day.

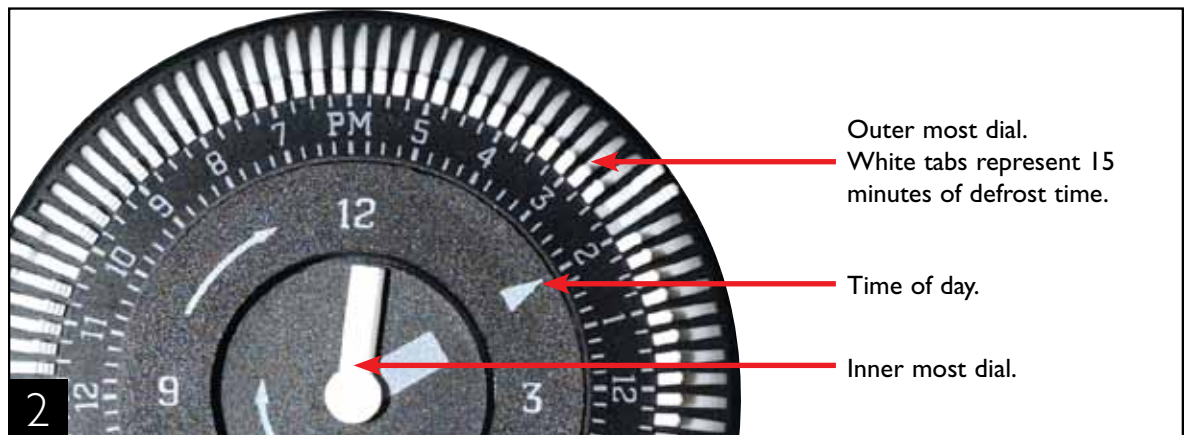

# ELECTRONIC TEMPERATURE CONTROLS

## LAE ELECTRONIC TEMPERATURE CONTROL GENERAL SEQUENCE OF OPERATION

- t1 = supply air / return air\* (thermostat)      \* STA, STG, STM, STR Models.  
 t2 = coil / copper line (defrost)  
 t3 = return air / supply air\* (display)

t3 probe is not installed and / or activated in all applications  
 with t3 is not installed and / or activated, the display probe is t1.



## LAE ELECTRONIC CONTROL GENERAL SEQUENCE OF OPERATION

1. Cabinet is plugged in.
  - a. Display will illuminate.
  - b. Interior light will illuminate on Glass Door Models only. Solid door cabinet lights are controlled by the door switch.
2. After the LAE control preprogrammed time delay of up to 6 minutes, the compressor and evaporator fan(s) will start if the control is calling for cooling.
  - a. Control or condenser fans may be already pre-programmed from the factory so at the start of every compressor cycle or during a defrost cycle, the condenser fan(s) will reverse for 30 seconds to blow dirt off the condensing coil.
3. The LAE control will cycle the compressor but may also cycle evaporator fan(s) on and off determined by the Set-Point and Differential temperatures.
  - a. The Set-Point is the adjustable preprogrammed temperature which shuts off the compressor and evaporator fan(s). This is not the programmed cabinet temperature.
  - b. The Differential is the non adjustable preprogrammed temperature that is added to the Set-Point temperature that will restart the compressor and evaporator fan(s).
  - c. The LAE control is designed to read and display a cabinet temperature **not a product temperature**. This cabinet temperature may reflect the refrigeration cycle of the Set-Point and it's Differential. The most accurate temperature on a cabinets operation is to verify the product temperature.

**Example: If the Set-Point is -9°F/-23°C and the Differential is 10°F/5°C  
 (Set-Point) -9°F + 10 (Differential) = 1°F**

Or

**(Set-Point) -23°C + 5 (Differential) = -18°C  
 The compressor and evaporator fan(s) will cycle off -9°F/-23°C and back on at 1°F/-18°C**

4. The LAE control may be preprogrammed to initiate defrost by interval or at specific times of day.
  - a. At this time the "dEF" will appear on the display and compressor will turn off until a preprogrammed temperature or duration is reached. During this time for freezers only, evaporator fan(s) will also turn off and the coil heater and drain tube heaters will also be energized. Some cabinets may also change the rotation of the reversing condenser fan motor.
  - b. After the preprogrammed temperature or duration for defrost has been reached there may be a short delay for both the compressor and evaporator fans to restart. At this time "dEF" may still appear on the display for a short time.

## HOW TO DIAGNOSE AN LAE ELECTRONIC CONTROL

Indicator lights for Refrigeration/Heating Mode, Fan Operation, Defrost Mode.

LAE Control	LAE Control Icons
 <p data-bbox="147 716 282 810">Info / Set Point Button</p> <p data-bbox="391 716 542 810">Manual Defrost / Down Button</p> <p data-bbox="651 716 813 810">Manual Activation Up Button</p> <p data-bbox="932 716 1013 810">Stand-By Button</p>	<ul style="list-style-type: none"> <li data-bbox="1149 449 1414 491"> Compressor Running</li> <li data-bbox="1149 516 1438 558"> Evaporator Fan Running</li> <li data-bbox="1149 583 1390 625"> Cabinet in Defrost</li> <li data-bbox="1149 651 1511 693"> Activation of 2nd Parameter Set</li> <li data-bbox="1149 718 1281 760"> Alarm</li> </ul>

## USING THE LAE ELECTRONIC CONTROL



### LOCKING AND UNLOCKING THE LAE CONTROLLER:

**WHY:** Locking of control is necessary to prevent changes to program that may affect cabinet operation.

#### HOW TO LOCK AND UNLOCK LAE CONTROLLER:

**STEP 1** - To change lock setting press and release the Info button . "tl" will appear. See image 1.

**STEP 2** - Press the Down button  until "Loc" appears. See image 2.

**STEP 3** - While pressing and holding the Info button  press the Up  or Down  button to change the lock settings. If "no" appears, the controller is unlocked. If "yes" appears, the controller is locked. See images 3 and 4.

**STEP 4** - Once the lock setting has been set correctly release the info button . Wait 5 seconds for the display to show temperature. See image 5.



Image 3: If "no" appears on screen, the controller is unlocked.



Image 4: If "yes" appears on screen, the controller is locked.



LAE Control



  
Info / Set Point  
Button

  
Manual Defrost /  
Down Button

  
Manual Activation  
Up Button

  
Stand-By  
Button

**HOW TO TURN OFF THE LAE ELECTRONIC CONTROL:**

May need to unlock control.

**WHY:** Turning off the control will deactivate all electrical components.

**CAUTION:** Turning off the control will not shut off power to the cabinet. Cabinet must be unplugged prior to any repair.

**HOW TO TURN OFF THE LAE ELECTRONIC CONTROL:**

**STEP 1** - To turn off control, press and hold the Stand-by button  until "OFF" appears. Release Stand-by button. See Image 2.

**STEP 2** - To turn on control, repeat prior steps and a temperature will appear.



**TURNING THE GLASS DOOR MODEL LIGHTS ON AND OFF:**

May need to unlock control.

**WHY:** Light may be controlled by LAE Controller or interior light switch.

**HOW TO TURN THE GLASS DOOR MODEL LIGHT ON AND OFF:**

**STEP 1** - To control interior / sign lights by the LAE Controller, press and release the Manual Activation button .

**STEP 2** - To control interior / sign lights by the interior door switch, depress the rocker switch to the "ON" position. Light switch is located on inside top right of the ceiling.

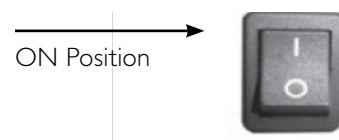

(Solid Door model lights are controlled by a door switch)

LAE Control

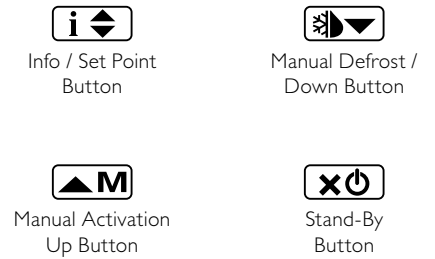

**CHANGING THE "SET POINT":**



May need to unlock control.

**WHY:** The set point is the temperature at which the compressor will shut off.

**NOTE:** The "set point" *IS NOT* the cabinet holding temperature.

**HOW TO CHANGE THE "SET POINT":**

**STEP 1** - To see the set point, press and hold the Info button . See image 1.

**STEP 2** - While still holding the Info button , press the Up  or Down  button to change the "set point".

**STEP 3** - Once the "set point" has been set correctly release the Info button . The display will show temperature. See image 2.



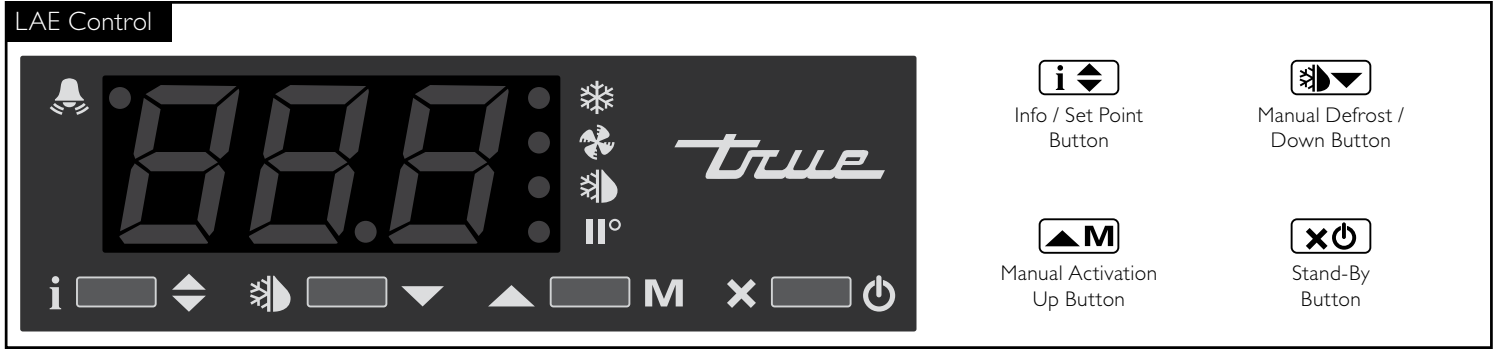

**INITIATE A MANUAL DEFROST:**

May need to unlock control.

**WHY:** A one time additional defrost may be necessary to clear accumulated frost / ice from evaporator coil.



**HOW TO INITIATE A MANUAL DEFROST:**

*The method to initiate a manual defrost is determined by the Defrost Mode Parameter "DTM" preprogrammed in the controller.*

**REGULAR TIME DEFROST (TIM)**

If controller is preprogrammed for "TIM", press and release the Manual Defrost button  until "dEF" appears.

**REAL TIME CLOCK (RTC)**

If controller is preprogrammed for "RTC" press the and hold the Manual Defrost button  for 5 seconds until "dh1" appears. Release the Manual Defrost button  and then press and hold for an additional 5 seconds until "dEF" appears.

**NOTE:** Defrost will only terminate once a specific preset temperature or a preset time duration is reached.



LAE Control

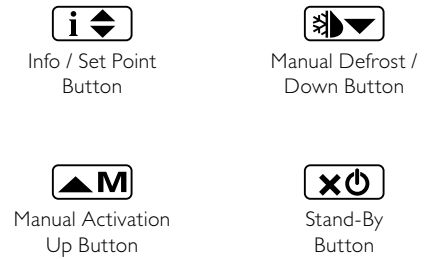

**CHANGING “DEFROST INTERVALS”:**

May need to unlock control.

This can only be changed if defrost mode parameter “DFM” is set for “TIM”.

**WHY:** The defrost interval is the time duration between defrost cycles. The defrost interval time starts when the cabinet is supplied power or after a manual defrost.

**HOW TO CHANGE “DEFROST INTERVALS”:**

**STEP 1** - To see the set point, press and hold the Info button (i with up/down arrows) and the Stand-by button (X with power symbol) at the same time.

**NOTE:** Depending on the version of control, one of three parameters will appear: “ScL” image 1a, “SPL” image 1b, “MdL” image 1c.

**STEP 2** - Push the Up button (M with up arrow) until “dFt” appears. See image 2.

**STEP 3** - Press and hold the Info button (i with up/down arrows) to see the defrost interval time. See image 3.

**STEP 4** - While pressing and holding the Info button (i with up/down arrows), press the Up (M with up arrow) or Down (snowflake with down arrow) button to change the defrost interval times (higher the number the less frequent the cabinet will defrost).

**STEP 5** - Once the defrost interval time has been changed, release the Info button (i with up/down arrows).

**STEP 6** - Wait 30 seconds for the display to show temperature. See image 4.



LAE Control



Info / Set Point Button



Manual Defrost / Down Button



Manual Activation Up Button



Stand-By Button



**HOW TO CHANGE DISPLAY READOUT FROM FAHRENHEIT TO CELSIUS:**

May need to unlock control.

*This can only be changed with the LAE model BRL version of the control.*



**WHY:** Changing readout will assist with customer application.

**HOW TO CHANGE DISPLAY READOUT FROM FAHRENHEIT TO CELSIUS:**

**STEP 1** - To change the display, press and hold the Info button  and the Stand-by button  at the same time. "Mdl" will appear. See image 1.

**STEP 2** - Push the Down button  until "ScL" appears. See image 2.

**STEP 3** - Press and hold the Info button  to see the "readout scale". See image 3.

**STEP 4** - While pressing and holding the Info button , press the up  or down  button to change the "readout scale". See image 4.

**STEP 5** - Once the "readout scale" has been changed, release the info button .

**STEP 6** - Wait 30 seconds for the display to show temperature. See image 5.



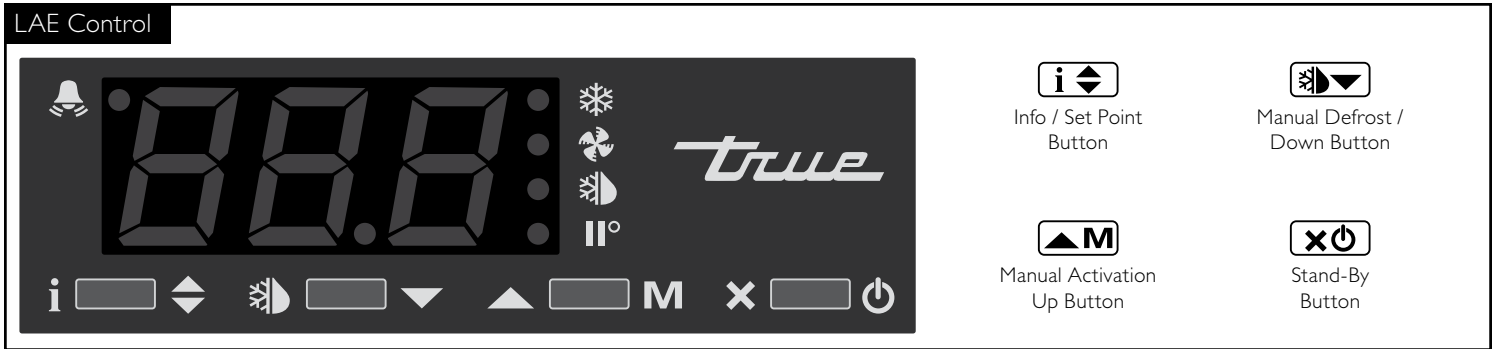

### DISPLAYING TEMPERATURE PROBES, T1, T2, T3:



**WHY:** To display temperature probe readings in different locations of the cabinet.

#### HOW TO DISPLAY PROBE TEMPERATURES:

**STEP 1** - To display T1 temperature, press and release the info button . "t1" will appear. See image 1.

**STEP 2** - Press and hold the info button . This is the temperature of the T1 Probe. See image 2.

**STEP 3** - By releasing the info button , "t2" will appear. Press and hold the info button  to display the temperature of the T2 probe.

**STEP 4** - By releasing the info button  again, "t3" will appear. Press and hold the info button  to display the temperature of the T3 probe. (If probe T3 is not activated, "t3" will not appear of the display.)



### DISPLAY CODES

DISPLAY			
dEF	Defrost in progress	hi	Room high temperature alarm
oFF	Controller in stand-by	Lo	Room low temperature alarm
do	Door open alarm	E1	Probe T1 failure
t1	Instant Probe 1 temperature	E2	Probe T2 failure
t2	Instant Probe 2 temperature	E3	Probe T3 failure
t3	Instant Probe 3 temperature	thi	Maximum probe 1 temperature recorded
nin	Minutes of the Real Time Clock	tLo	Minimum probe 1 temperature recorded
hrs	Hours of the Real Time Clock	Loc	Keypad state lock

### LAE Controller Parameter Settings for Celsius

For every model / version of the LAE controller,

**ALL** parameters with a formula shown need to be

converted for Celsius applications.

#### **EXCEPT MODEL: BR1**

EXAMPLE:

If current SPL is set for 20 degrees F,  
the formula is  $(X-32) / 1.8$

$$(20-32) / 1.8 = -6.7 \text{ Celcius}$$

AR2-28	
SCL	1C
SPL	$(X-32) / 1.8$
SPH	$(X-32) / 1.8$
SP	$(X-32) / 1.8$
C-H	
HYS	$(X) / 1.8$
CRT	
CT1	
CT2	
CSD	
DFM	
DFT	
DH1	
DH2	
DH3	
DH4	
DH5	
DH6	
DLI	$(X-32) / 1.8$
DTO	
DTY	
DPD	
DRN	
DDM	
DDY	
FID	
FDD	$(X-32) / 1.8$
FTO	
FCM	
FDT	$(X) / 1.8$
FDH	$(X) / 1.8$
FT1	
FT2	
FT3	
ATM	
ALA	$(X-32) / 1.8$
AHA	$(X-32) / 1.8$
ALR	$(X) / 1.8$
AHR	$(X) / 1.8$
ATI	
ATD	

BIT25	
SPL	$(X-32) / 1.8$
SPH	$(X-32) / 1.8$
SP	$(X-32) / 1.8$
HYS	$(X) / 1.8$
CT1	
CT2	
CSD	
DFM	
DFT	
DFB	
DLI	$(X-32) / 1.8$
DTO	
DTY	
DPD	
DRN	
DDM	
DDY	
FID	
FDD	$(X-32) / 1.8$
FTO	
FCM	
FDT	$(X) / 1.8$
FDH	$(X) / 1.8$
FT1	
FT2	
FT3	
ATM	
ALA	$(X-32) / 1.8$
AHA	$(X-32) / 1.8$
ALR	$(X) / 1.8$
AHR	$(X) / 1.8$
ATI	
ATD	

BIT25 Heating	
SPL	$(X-32) / 1.8$
SPH	$(X-32) / 1.8$
SP	$(X-32) / 1.8$
CM	
HYS	$(X) / 1.8$
TON	
TOF	
PB	
IT	
DT	
AR	
CT	
PF	
HSD	
ATM	
ALA	$(X-32) / 1.8$
AHA	$(X-32) / 1.8$
ALR	$(X) / 1.8$
AHR	$(X) / 1.8$
ATD	

ADO	
AHM	
AHT	$(X-32) / 1.8$
ACC	
IISL	$(X-32) / 1.8$
IISH	$(X-32) / 1.8$
IISP	$(X-32) / 1.8$
IIHY	$(X) / 1.8$
IIFC	
IIDF	
SB	
DI1	
DI2	
T3M	
OS3	$(X) / 1.8$
PSL	$(X-32) / 1.8$
PSR	$(X-32) / 1.8$
POF	
LSM	
OA1	
OA2	
OS1	$(X) / 1.8$
T2	
OS2	$(X) / 1.8$
TLD	
SCL	1C
SIM	
ADR	

## SOLLATEK ELECTRONIC TEMPERATURE CONTROL GENERAL SEQUENCE OF OPERATION

control probe = return air

defrost probe = coil



## SOLLATEK ELECTRONIC TEMPERATURE CONTROL GENERAL SEQUENCE OF OPERATION

1. Cabinet is plugged in.
  - a. Interior lights will illuminate on glass door models only. If the lights do not come on verify the light switch is in the "ON" position. Solid door cabinets may or may not have lights that may be controlled by the door switch.
2. The compressor and evaporator fans will start if the temperature control is calling for cooling. (If the compressor does not start verify that the temperature control is not in the "off" or "0" position.)
  - a. Control or condenser fan(s) may be already preprogrammed from the factory so at the start of every compressor cycle, the condenser fan(s) will reverse for 30 seconds to blow dirt off the condensing coil.
3. The Sollatek control will cycle the compressor and the evaporator fan(s) on and off together.
  - a. The temperature control is sensing the discharge air temperature.
  - b. The temperature control should be set on the #4 or #5.
  - c. The warmest setting is #1, the coldest is #9, and #0 is the off position.
  - d. The thermometer is designed to read and display a cabinet temperature not a product temperature. This cabinet temperature may reflect the refrigeration cycle determined by the temperature control. The most accurate temperature on a cabinets operation is to verify the product temperature.
4. The Sollatek control is preprogrammed to initiate defrost every 4 hours of compressor run time. If deemed necessary by the Sollatek control additional defrost may occur at unspecified times.
  - a. At this time, the evaporator fans will continue to run but the compressor will turn off. Some cabinets may also change the rotation of the reversing condenser fan motor.
  - b. Once a preprogrammed temperature of the evaporator coil is reached, the Defrost Cycle will terminate and the 2 minute delay will start.
  - c. After the 2 minute delay the compressor will restart.

# MAINTENANCE, CARE, CLEANING

## CLEANING THE CONDENSER COIL

When using electrical appliances, basic safety precautions should be followed, including the following:

### TOOLS REQUIRED

- Phillips Screwdriver
- Stiff Bristle Brush
- Adjustable Wrench
- Air Tank or CO<sub>2</sub> Tank
- Vacuum Cleaner

**STEP 1** - Disconnect power to unit.

### STEP 2

#### SLIDE DOOR MODELS:

Remove louver grill by removing Phillips screw located on either side of the louver grill. (See image 1). Pull the louver grill out from the cabinet front. (See image 2). (To reinstall grill, place louver grill back into brackets located at the base of the unit (See image 3). Snap top of louver grill into place. Replace screws).

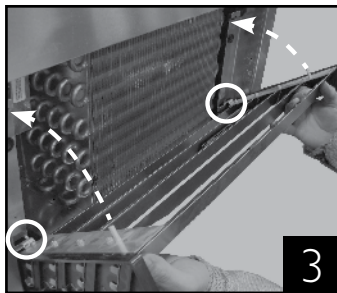
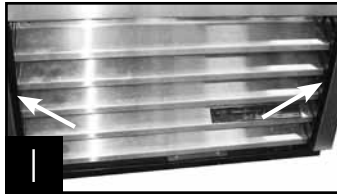

#### SWING DOOR MODELS:

Take off lower grill assembly by removing four (4) screws.

(See images 4 & 5.)



Loosen but do not remove 4 Phillips screws inside the grill frame.



Lift the grill up until it clears the screw key hole slots.

**STEP 3** - Remove bolts anchoring compressor assembly to frame rails and carefully slide out. (tube connections are flexible)

**STEP 4** - Clean off accumulated dirt from condensing coil with a stiff bristle brush.

**STEP 5** - Lift cardboard cover above fan at plastic plugs and carefully clean condenser coil and fan blades.

### STEP 6

#### INDOOR LOCATION:

After brushing condenser coil vacuum dirt from coil, and interior floor:

#### OUTDOOR LOCATION:

(GDM-33, GDM-47, and GDM-49 only) After brushing condenser coil blow CO<sub>2</sub> through condenser from fin side to fan.

**STEP 7** - Replace cardboard cover. Carefully slide compressor assembly back into position and replace bolts.

**STEP 8** - Reinstall louver assembly onto unit with appropriate fasteners and clips. Tighten all screws.

**STEP 9** - Connect unit to power and check to see if condenser is running.

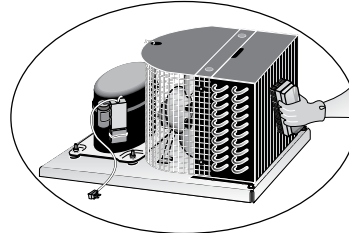

Indoor Location

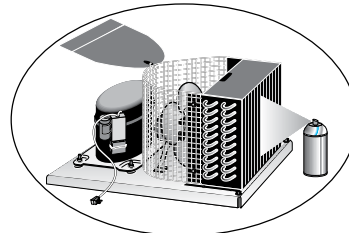

Outdoor Location

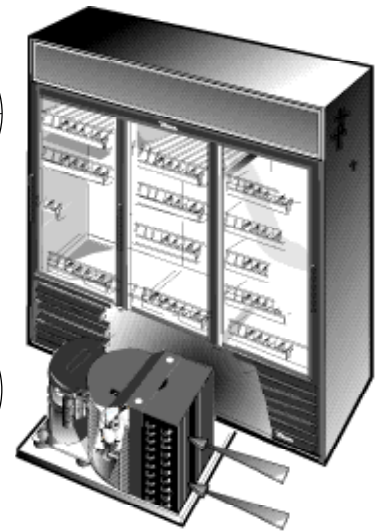

## IMPORTANT WARRANTY INFORMATION

Condensers accumulate dirt and require cleaning every 30 days. Dirty condensers result in compressor failure, product loss, and lost sales, which are not covered by warranty.

If you keep the Condenser clean you will minimize your service expense and lower your electrical costs. The Condenser requires scheduled cleaning every thirty days or as needed.

Air is pulled through the Condenser continuously, along with dust, lint, grease, etc.

A dirty Condenser can result in NON-WARRANTEED part & Compressor Failures, Product Loss, and Lost Sales.

Proper cleaning involves removing dust from the Condenser. By using a soft brush, or vacuuming the Condenser with a shop vac, or using CO<sub>2</sub>, nitrogen, or pressurized air.

If you cannot remove the dirt adequately, please call your refrigeration service company.

On most of the reach-in units the condenser is accessible in the rear of the unit. You must remove the cabinet grill to expose the Condenser.

The Condenser looks like a group of vertical fins. You need to be able to see through the condenser for the unit to function at maximum capacity. Do not place filter material in front of condensing coil. This material blocks air-flow to the coil similar to having a dirty coil.

## THE CLEANING OF THE CONDENSER IS NOT COVERED BY THE WARRANTY!

### HOW TO CLEAN THE CONDENSER:

1. Disconnect the electrical power to the unit.
2. Remove the louvered grill.
3. Vacuum or brush the dirt, lint, or debris from the finned condenser coil.
4. If you have a significant dirt build up you can blow out the condenser with compressed air.

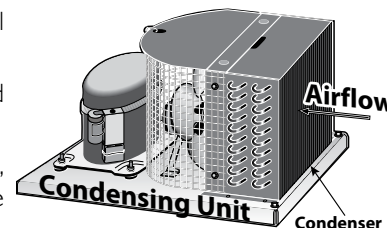

### (CAUTION MUST BE USED TO AVOID EYE INJURY. EYE PROTECTION IS RECOMMENDED.)

5. When finished be sure to replace the louvered grill. The grill protects the condenser.
6. Reconnect the electrical power to the unit.

If you have any questions, please call TRUE Manufacturing at 636-240-2400 or 800-325-6152 and ask for the Service Department. Direct to Service Department 1 (855)372-1368. Service Department Availability Monday-Thursday 7:00 a.m. to 7:00 p.m., Friday 7:00 a.m. to 6:00 p.m. and Saturday 8:00 a.m. to 12:00 p.m. CST.

## STAINLESS STEEL EQUIPMENT CARE AND CLEANING

**CAUTION:** Do not use any steel wool, abrasive or chlorine based products to clean stainless steel surfaces.

### STAINLESS STEEL OPPONENTS

There are three basic things which can break down your stainless steel's passivity layer and allow corrosion to rear its ugly head.

1. Scratches from wire brushes, scrapers, and steel pads are just a few examples of items that can be abrasive to stainless steel's surface.
2. Deposits left on your stainless steel can leave spots. You may have hard or soft water depending on what part of the country you live in. Hard water can leave spots. Hard water that is heated can leave deposits if left to sit too long. These deposits can cause the passive layer to break down and rust your stainless steel. All deposits left from food prep or service should be removed as soon as possible.
3. Chlorides are present in table salt, food, and water. Household and industrial cleaners are the worst type of chlorides to use.

### RECOMMENDED CLEANERS FOR CERTAIN SITUATIONS / ENVIRONMENTS OF STAINLESS STEEL

- A. Soap, ammonia and detergent medallion applied with a cloth or sponge can be used for routine cleaning.
- B. Arcal 20, Lac-O-Nu Ecoshine applied provides barrier film for fingerprints and smears.
- C. Cameo, Talc, Zud First Impression is applied by rubbing in the direction of the polished lines for stubborn stains and discoloring.
- D. Easy-off and De-Grease It oven aid are excellent for removals on all finishes for grease-fatty acids, blood and burnt-on foods.
- E. Any good commercial detergent can be applied with a sponge or cloth to remove grease and oil.
- F. Benefit, Super Sheen, Sheila Shine are good for restoration / passivation.

**NOTE:** The use of stainless steel cleaners or other such solvents is not recommended on plastic parts. Warm soap and water will suffice.

## 8 STEPS THAT CAN HELP PREVENT RUST ON STAINLESS STEEL:

### 1. USING THE CORRECT CLEANING TOOLS

Use non-abrasive tools when cleaning your stainless steel products. The stainless steel's passive layer will not be harmed by soft cloths and plastic scouring pads. Step 2 tells you how to find the polishing marks.

### 2. CLEANING ALONG THE POLISH LINES

Polishing lines or "grain" are visible on some stainless steels. Always scrub parallel to visible lines on some stainless steels. Use a plastic scouring pad or soft cloth when you cannot see the grain.

### 3. USE ALKALINE, ALKALINE CHLORINATED OR NON-CHLORIDE CONTAINING CLEANERS

While many traditional cleaners are loaded with chlorides, the industry is providing an ever increasing choice of non-chloride cleaners. If you are not sure of your cleaner's chloride content contact your cleaner supplier. If they tell you that your present cleaner contains chlorides, ask if they have an alternative. Avoid cleaners containing quaternary salts as they can attack stainless steel, causing pitting and rusting.

### 4. WATER TREATMENT

To reduce deposits, soften the hard water when possible. Installation of certain filters can remove corrosive and distasteful elements. Salts in a properly maintained water softener can be to your advantage. Contact a treatment specialist if you are not sure of the proper water treatment.

### 5. MAINTAINING THE CLEANLINESS OF YOUR FOOD EQUIPMENT

Use cleaners at the recommended strength (alkaline chlorinated or non-chloride). Avoid build-up of hard stains by cleaning frequently. When boiling water with your stainless steel equipment, the single most likely cause of damage is chlorides in the water. Heating any cleaners containing chlorides will have the same damaging effects.

### 6. RINSE

When using chlorinated cleaners you must rinse and wipe dry immediately. It is better to wipe standing cleaning agents and water as soon as possible. Allow the stainless steel equipment to air dry. Oxygen helps maintain the passivity film on stainless steel.

### 7. HYDROCHLORIC ACID (MURIATIC ACID) SHOULD NEVER BE USED ON STAINLESS STEEL

### 8. REGULARLY RESTORE/PASSIVATE STAINLESS STEEL



## GENERAL MAINTENANCE

### LIGHT BULB REPLACEMENT (IDL) INTEGRATED DOOR LIGHTING

**WARNING:** When replacing a light bulb make sure power to the unit is either turned off or unplugged.

#### IDL (INTEGRATED DOOR LIGHTING):

- Squeeze the plastic lampshield together and pull away from the door (See Image 1).
- Push the bulb down while pulling the spring activated lampholder up. This will give you enough clearance to take the bulb out (See Image 2).



Remove the lampshield to reveal the bulb. Squeeze the sides of the lampshield at the same time pulling it away from the bulb.



The lamp holders are spring activated. Pull the top lamp holder up and push the bulb down at the same time. This will leave enough clearance to remove the bulb.

### LIGHT COVER INSTALLATION FOR GDM-10F & GDM-12F

#### IMPORTANT

Before installing lamp cover turn cabinet on and allow it to reach temperature.

#### STEP 1

Locate rubber gasket behind lamp holder mounted to evaporator housing. (See Image 1).

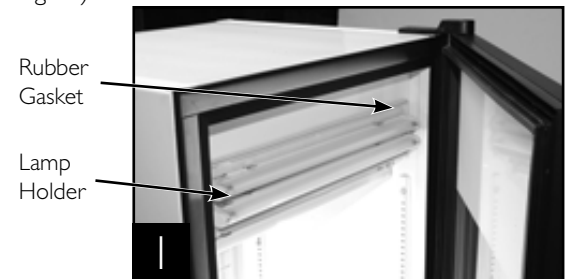

#### STEP 2

Fit the bottom edge of the lamp cover into the bottom groove of the rubber gasket and rotate upwards while working the edges into the rest of the rectangular groove. (See Images 2-3). (slide fingers underneath top edges of rubber gasket and push rubber over the top lip of the lamp shield).

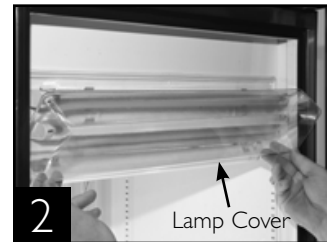

#### STEP 3

Be sure lamp cover is seated properly in rubber gasket.

#### NOTE

If cabinet is turned off and interior allowed to warm up lamp cover may become loose and require reinstallation. Follow directions above.

**FOR ADDITIONAL MAINTENANCE INSTRUCTION,  
PLEASE VISIT THE MEDIA CENTER AT  
WWW.TRUEMFG.COM**



# WARRANTY INFORMATION (U.S.A & CANADA ONLY!)

**THIS WARRANTY ONLY APPLIES TO UNITS SHIPPED FROM TRUE'S MANUFACTURING FACILITIES AFTER JULY 1, 2014.**

## THREE YEAR PARTS & LABOR WARRANTY

TRUE warrants to the original purchaser of every new TRUE refrigerated unit, the cabinet and all parts thereof, to be free from defects in material or workmanship, under normal and proper use and maintenance service as specified by TRUE and upon proper installation and start-up in accordance with the instruction packet supplied with each TRUE unit. TRUE's obligation under this warranty is limited to a period of three (3) years from the date of original installation or 39 months after shipment date from TRUE, whichever occurs first.

Any part covered under this warranty that are determined by TRUE to have been defective within three (3) years of original installation or thirty-nine (39) months after shipment date from manufacturer, whichever occurs first, is limited to the repair or replacement, including labor charges, of defective parts or assemblies. The labor warranty shall include standard straight time labor charges only and reasonable travel time, as determined by TRUE.

Warranty does not cover standard wear parts which include door gaskets, incandescent bulbs or fluorescent bulbs. Warranty also does not cover issues caused by improper installation or lack of basic preventative maintenance which includes regular cleaning of condenser coils.

## ADDITIONAL TWO YEAR COMPRESSOR WARRANTY

In addition to the Three (3) year warranty stated above, TRUE warrants its hermetically and semi-hermetically sealed compressor to be free from defects in both material and workmanship under normal and proper use and maintenance service for a period of two (2) additional years from the date of original installation but not to exceed five (5) years and three (3) months after shipment from the manufacturer.

Compressors determined by TRUE to have been defective within this extended time period will, at TRUE's option, be either repaired or replaced with a compressor or compressor parts of similar design and capacity.

The two (2) year extended compressor warranty applies only to hermetically and semi-hermetically sealed parts of the compressor and does not apply to any other parts or components, including, but not limited to: cabinet, paint finish, temperature control, refrigerant, metering device, driers, motor starting equipment, fan assembly or any other electrical component, etcetera.

## 404A/134A COMPRESSOR WARRANTY

The two year compressor warranty detailed above will be voided if the following procedure is not carefully adhered to:

1. This system contains R404A or R134A refrigerant and polyol ester lubricant. The polyol ester lubricant has rapid moisture absorbing qualities. If long exposure to the ambient conditions occur, the lubricant must be removed and replaced with new. For oil amounts and specifications please call TRUE technical service department (855-372-1368). Failure to comply with recommended lubricant specification will void the compressor warranty.
2. Drier replacement is very important and must be changed when a system is opened for servicing. A drier using XH-7 desiccant or an exact replacement solid core drier must be used. The new drier must also be the same capacity as the drier being replaced.
3. Micron level vacuums must be achieved to insure low moisture levels in the system. 500 microns or lower must be obtained.

## WARRANTY CLAIMS

All claims for labor or parts must be made directly through TRUE. All claims should include: model number of the unit, the serial number of the cabinet, proof of purchase, date of installation, and all pertinent information supporting the existence of the alleged defect.

In case of warranty compressor, the compressor model tag must be returned to TRUE along with above listed information.

Any action or breach of these warranty provisions must be commenced within one (1) year after that cause of action has occurred.

## WHAT IS NOT COVERED BY THIS WARRANTY

TRUE's sole obligation under this warranty is limited to either repair or replacement of parts, subject to the additional limitations below. This warranty neither assumes nor authorizes any person to assume obligations other than those expressly covered by this warranty.

**NO CONSEQUENTIAL DAMAGES.** TRUE IS NOT RESPONSIBLE FOR ECONOMIC LOSS; PROFIT LOSS; OR SPECIAL, INDIRECT, OR CONSEQUENTIAL DAMAGES, INCLUDING WITHOUT LIMITATION, LOSSES OR DAMAGES ARISING FROM FOOD OR PRODUCT SPOILAGE CLAIMS WHETHER OR NOT ON ACCOUNT OF REFRIGERATION FAILURE. **WARRANTY IS NOT TRANSFERABLE.** This warranty is not assignable and applies only in favor of the original purchaser/user to whom delivered. ANY SUCH ASSIGNMENT OR TRANSFER SHALL VOID THE WARRANTIES HEREIN MADE AND SHALL VOID ALL WARRANTIES, EXPRESS OR IMPLIED, INCLUDING ANY WARRANTY OF MERCHANTABILITY OR FITNESS FOR A PARTICULAR PURPOSE.

**IMPROPER USAGE.** TRUE ASSUMES NO LIABILITY FOR PARTS OR LABOR COVERAGE FOR COMPONENT FAILURE OR OTHER DAMAGES RESULTING FROM IMPROPER USAGE OR INSTALLATION OR FAILURE TO CLEAN AND/OR MAINTAIN PRODUCT AS SET FORTH IN THE WARRANTY PACKET PROVIDED WITH THE UNIT.

**RELOCATION OF CABINET FOR REPAIR:** True is not responsible for the cost to move a cabinet for any reason from its position of operation on the customer's premises to make a warranty repair.

**RESIDENTIAL APPLICATIONS:** TRUE assumes no liability for parts or labor coverage for component failure or other damages resulting from installation in non-commercial or residential applications.

**ALTERATION, NEGLIGENCE, ABUSE, MISUSE, ACCIDENT, DAMAGE DURING TRANSIT OR INSTALLATION, FIRE, FLOOD, ACTS OF GOD.** TRUE is not responsible for the repair or replacement of any parts that TRUE determines have been subjected after the date of manufacture to alteration, neglect, abuse, misuse, accident, damage during transit or installation, fire, flood, or act of God.

**IMPROPER ELECTRICAL CONNECTIONS.** TRUE IS NOT RESPONSIBLE FOR THE REPAIR OR REPLACEMENT OF FAILED OR DAMAGED COMPONENTS RESULTING FROM INCORRECT SUPPLY VOLTAGE, THE USE OF EXTENSION CORDS, LOW VOLTAGE, OR UNSTABLE SUPPLY VOLTAGE. **NO IMPLIED WARRANTY OF MERCHANTABILITY OR FITNESS FOR A PARTICULAR PURPOSE:** THERE ARE NO OTHER WARRANTIES, EXPRESSED, IMPLIED OR STATUTORY, EXCEPT THE THREE (3) YEAR PARTS & LABOR WARRANTY AND THE ADDITIONAL TWO (2) YEAR COMPRESSOR WARRANTY AS DESCRIBED ABOVE. THESE WARRANTIES ARE EXCLUSIVE AND IN LIEU OF ALL OTHER WARRANTIES, INCLUDING IMPLIED WARRANTY AND MERCHANTABILITY OR FITNESS FOR A PARTICULAR PURPOSE. THERE ARE NO WARRANTIES WHICH EXTEND BEYOND THE DESCRIPTION ON THE FACE HEREOF.

**OUTSIDE U.S./Canada:** This warranty does not apply to, and TRUE is not responsible for, any warranty claims made on products sold or used outside the United States/Canada. This warranty only applies to units shipped from True's manufacturing facilities after July 1, 2014.