

Features

- Vitreous china.
- Two-piece toilet.
- Comfort Height® Elongated bowl.
- AquaPiston® flushing system.
- Includes left-hand polished chrome trip lever.
- 1.28 gpf (4.8 lpf).
- 2-1/8" (54 mm) fully glazed trapway.
- 12" (305 mm) rough-in.
- Less seat and supply.
- 11-1/2" (292 mm) x 8-3/4" (222 mm) water area.
- 29-1/4" (743 mm) x 17-1/4" (438 mm) x 30-3/4" (781 mm).
- Floor mount / Floor outlet.

Optional Accessories

- K-9167-L Trip Lever
- K-4650 Toilet Seat
- K-7637 Angle Supply with Stop (single)

Components

Product includes:

- K-4397 Toilet Bowl
- K-4438 Toilet Tank

Additional included component/s: Tank cover, Trip lever, Bolt cap accessory pack, and Tank accessory pack.



ADA **CSA B651** **OBC**

Codes/Standards











ASME A112.19.2/CSA B45.1
DOE - Energy Policy Act 1992
EPA WaterSense®
California Energy Commission (CEC)
ADA
ICC/ANSI A117.1
CSA B651
OBC

KOHLER® One-Year Limited Warranty

See website for detailed warranty information.

Available Color/Finishes

Color tiles intended for reference only.

| Color | Code | Description |
|--|------|---------------|
|  | 0 | White |
|  | 96 | Biscuit |
|  | 47 | Almond |
|  | NY | Dune |
|  | 95 | Ice™ Grey |
|  | G9 | Sandbar |
|  | 33 | Mexican Sand™ |
|  | K4 | Cashmere |
|  | 58 | Thunder™ Grey |
|  | 7 | Black Black™ |

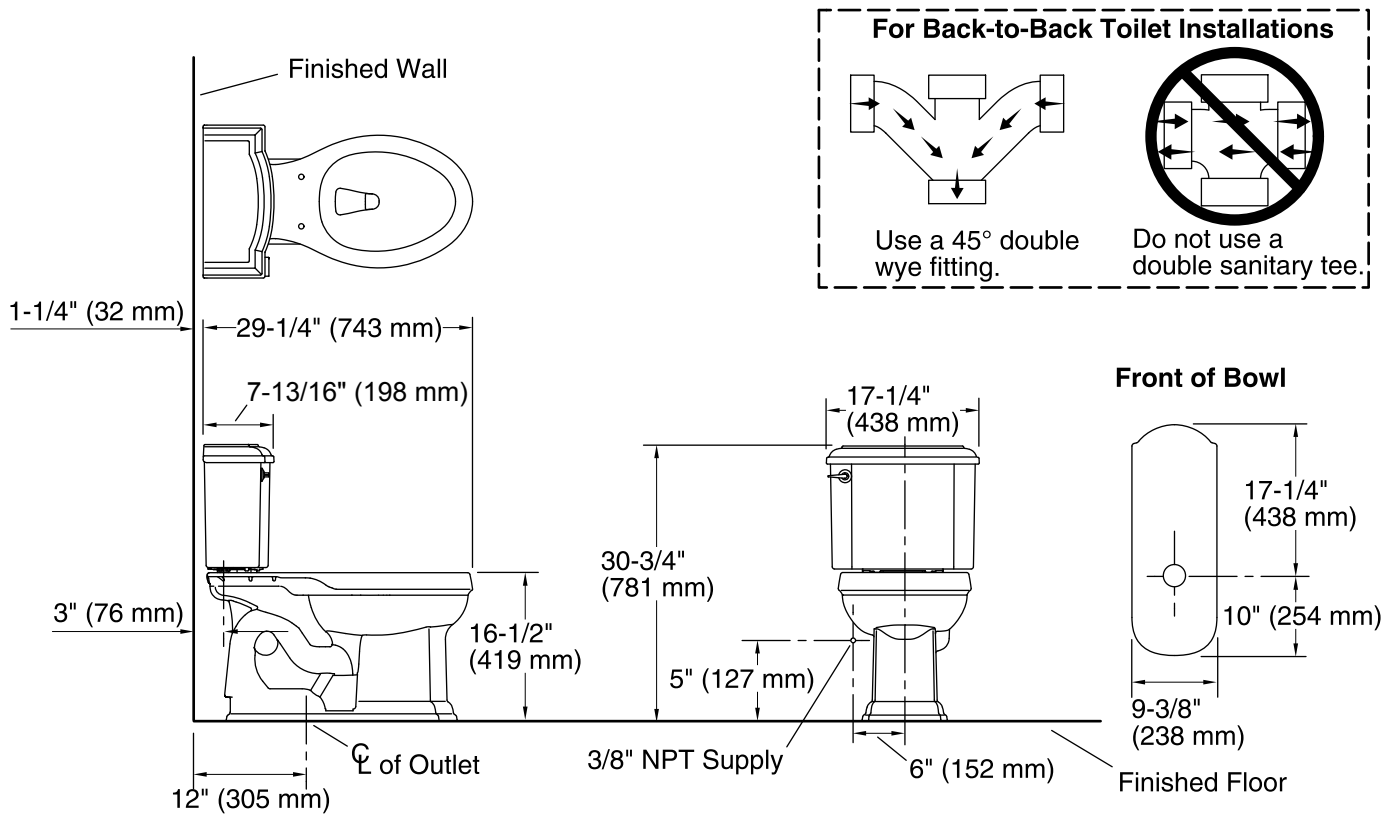

Technical Information

All product dimensions are nominal.

| | |
|-----------------------|------------------------------------|
| Toilet type: | Two-piece, Floor-mount |
| Waste Outlet: | Floor |
| Bowl shape: | Elongated front |
| Flush type: | AquaPiston |
| Trap passageway: | 2-1/8" (54 mm) |
| Water Consumption | |
| Full: | 1.28 gpf (4.8 lpf) |
| Water surface size: | 11-1/2" x 8-3/4" (292 mm x 222 mm) |
| Rim to water surface: | 5-1/2" (140 mm) |
| Rough-in: | 12" (305 mm) |
| Seat-mounting holes: | 5-1/2" (140 mm) |

Notes

Install this product according to the installation instructions.

For back-to-back toilet installations: Use only a 45° double wye fitting.

ADA, OBC, CSA B651 compliant when installed to the specific requirements of these regulations.

Plumbing Codes require elongated toilets and elongated, open-front toilet seats in public bathrooms.

Accessibility standards require controls to be located on the open side of the toilet.