

CLASSIC SERIES W2084W

FEATURES

Heavy-duty construction

Large-capacity stainless steel drum

Active Drum™ technology

Quattro Construction™ technology

Spin speed up to 1400 rpm

Steel Seal™ technology

LCD display

Quiet operation—51 dB(A) wash/75 dB(A) spin

Auto program

Remaining time and program end indicator

Stacked or side by side installation

HIDDEN HELPERS™ ACCESSORIES

Retractable ironing board system

Single and double retractable shelves

Pull-out utility basket

Platform

Accessories available through an authorized Asko dealer. For local dealer information, visit the where to buy section of our website, askona.com.

PROGRAMS

- Everyday Wash
- Standard Cotton
- Mix/Synthetic
- Wool/Hand Wash
- Dark Wash
- Time Program
- Auto
- Quick
- Heavy
- Rinse
- Spin
- Drain
- Easy Care
- Drum Cleaning
- Quick Pro

PRODUCT SPECIFICATIONS

White	W2084W
Dimensions	23 1/2"W x 33 1/2"H x 22 1/2"D
Door Clearance	16"
Door Swing	Left-Hinge
Weight	170 lb
Drum Capacity	2.1 cu ft
Max Spin Speed	1400 rpm
Plumbing Supply	1/2" ID min (cold only)
Pressure	15-146 psi
Power Cord	6'

A separate electrical service is not required. A receptacle for the washer is located on the back of the dryer.

DIMENSIONS

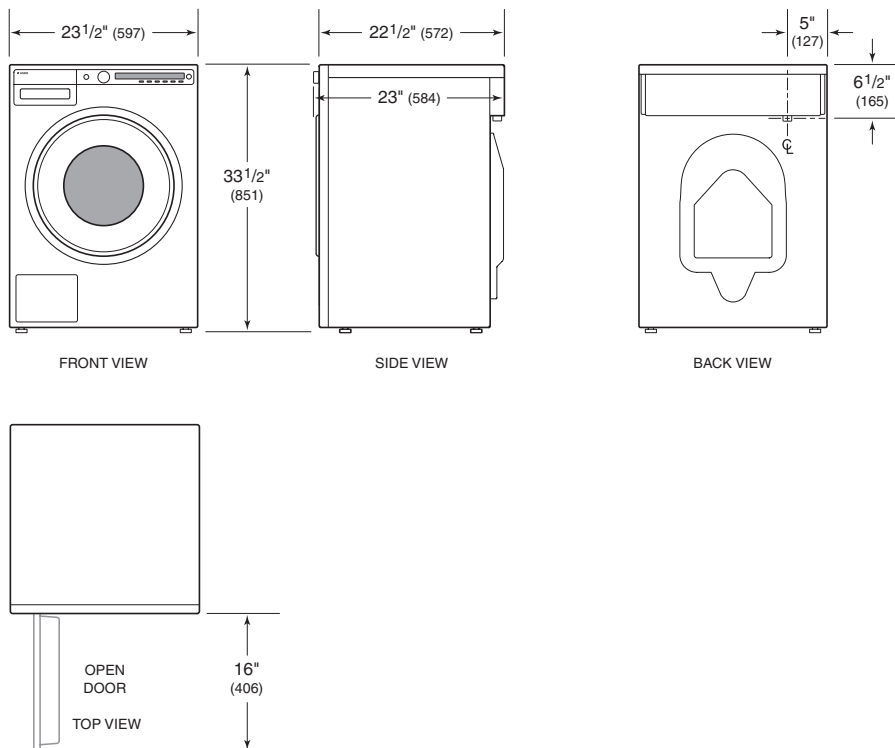

INSTALLATION

INSTALLATION WITH DRYER

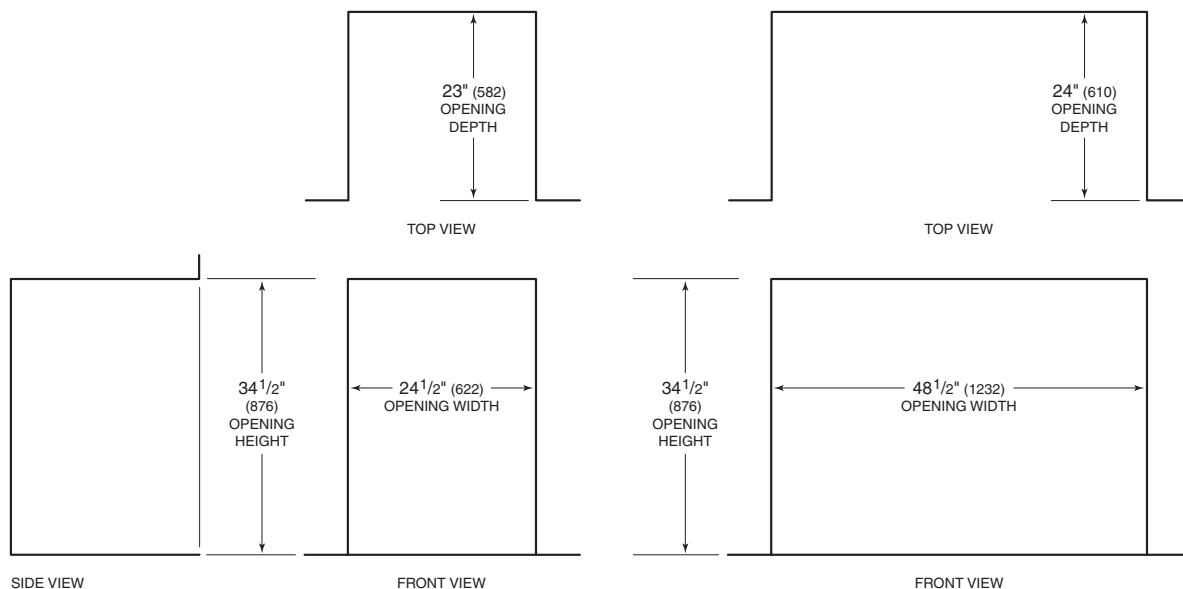

NOTE: Dimensions provide minimum reveals.

CLASSIC SERIES T208VW

FEATURES

Heavy-duty construction

Large-capacity stainless steel drum

Butterfly™ drying system

Soft Drum™ technology

LCD display

Quiet operation—65 dB(A)

Auto program

Remaining time and program end indicator

Stacked or side by side installation

Stack kit included

HIDDEN HELPERS™ ACCESSORIES

Retractable ironing board system

Single and double retractable shelves

Pull-out utility basket

Platform

Accessories available through an authorized Asko dealer. For local dealer information, visit the where to buy section of our website, askona.com.



PROGRAMS

- Auto Extra Dry
- Auto Dry
- Auto Normal Dry
- Auto Iron Dry
- Synthetic
- Bedding
- Quick Pro
- Time
- Airing

PRODUCT SPECIFICATIONS

White	T208VV
Dimensions	23 1/2"W x 33 1/2"H x 23 1/2"D
Door Clearance	19"
Door Swing	Right-Hinge
Weight	88 lb
Drum Capacity	4.1 cu ft
Electrical Supply	240/208 VAC, 60 Hz
Electrical Service	30 amp circuit
Receptacle	NEMA 14-30R grounding-type
Power Cord	4'

DIMENSIONS

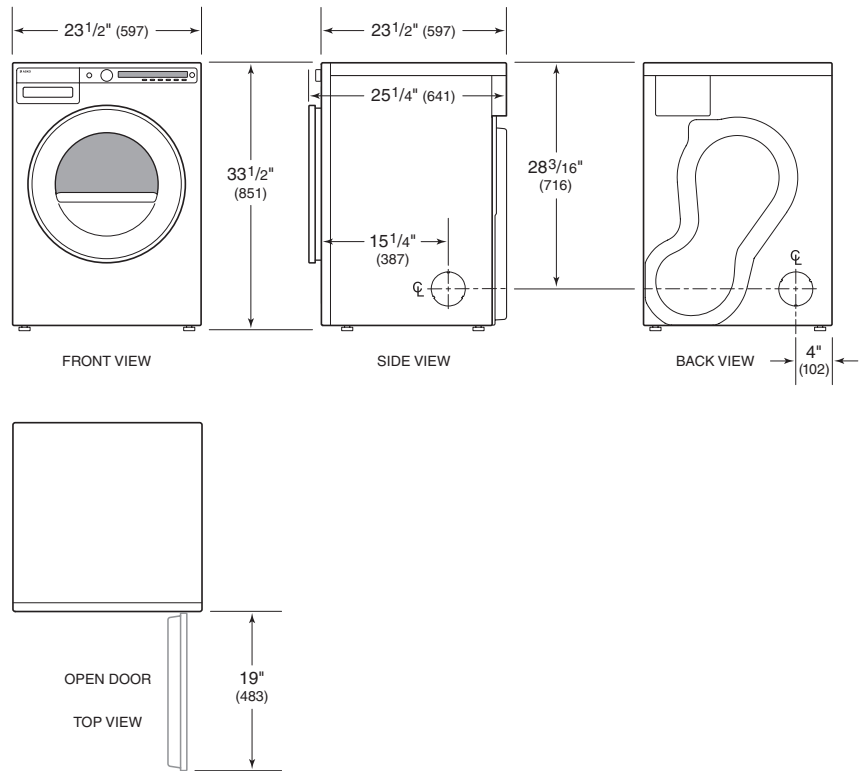

INSTALLATION

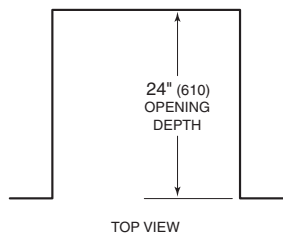

TOP VIEW

INSTALLATION WITH WASHER

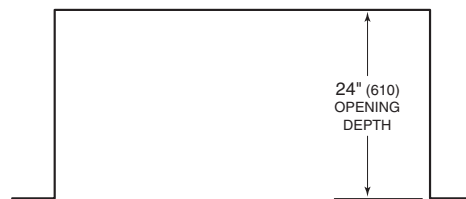

TOP VIEW

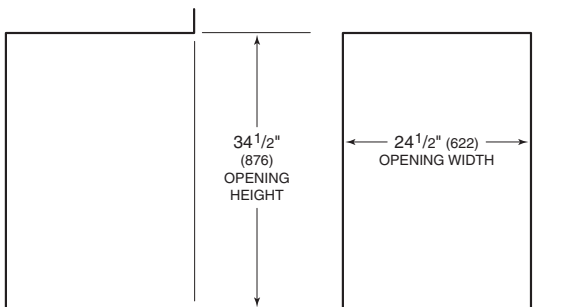

SIDE VIEW

FRONT VIEW

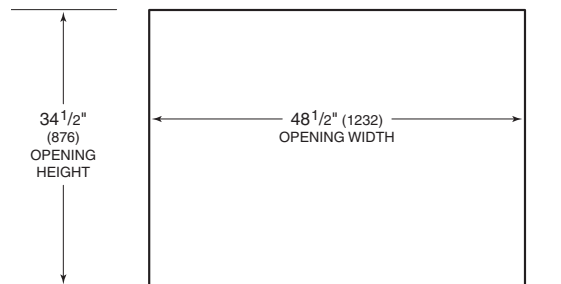

FRONT VIEW

NOTE: Dimensions provide minimum reveals.