



6,000 BTU/H CEILING MOUNTED IDU

SUBMITTAL COVER SHEET

PROJECT NAME _____

LOCATION _____

ARCHITECT _____

ENGINEER _____

CONTRACTOR _____

REFERENCE _____

SUBMITTED BY _____ DATE _____

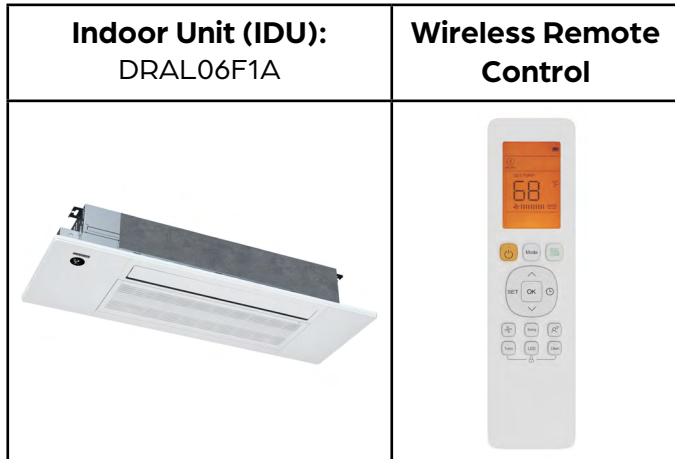

PRODUCT FEATURES

- Single or multi-zone compatible
- Wireless Remote Control with "Follow Me" Technology
- Slim design for easy install between 16" joists
- Serviceable from below
- Washable filter
- Humidity sensor
- Built in drain pump
- Sleep Mode
- Turbo Mode
- 24-Hour Timer Feature
- Quiet operation as low as 32.5 dB
- High efficiency up to 22 SEER2

SPECIFICATIONS		
Cooling Capacity (BTU/hr)	6500	
Heating Capacity (BTU/hr)	7100	
Voltage/Phase/Frequency	208-230V, 1 Phase, 60 Hz	
Voltage Range	187-253V	
Indoor Unit Air Flow (CFM)	Low	235
	Medium	259
	High	294
Drain Port O.D.	1"	
Drain Port Lift	20.8	
Recommended Breaker (Amps)	15	
Sound Pressure (dB(A))	Low	32.5
	Medium	35.5
	High	37.5
Refrigerant	R410A	

LINE SET REQUIREMENTS	
Connection Type	Flare
Liquid	Ø1/4" (Ø6.35mm)
Gas	Ø3/8" (Ø9.52mm)

DIMENSIONS AND WEIGHT		
Unit Dimensions	Width	50-5/16"
	Depth	13-3/16"
	Height	9"
Carton Dimensions	Width	57-5/8"
	Depth	22-1/2"
	Height	22-1/2"
Net Weight	58.4 lbs.	
Gross Weight	81.3 lbs.	





6,000 BTU/H CEILING MOUNTED IDU

IDU DIMENSIONS - DRAL06F1A

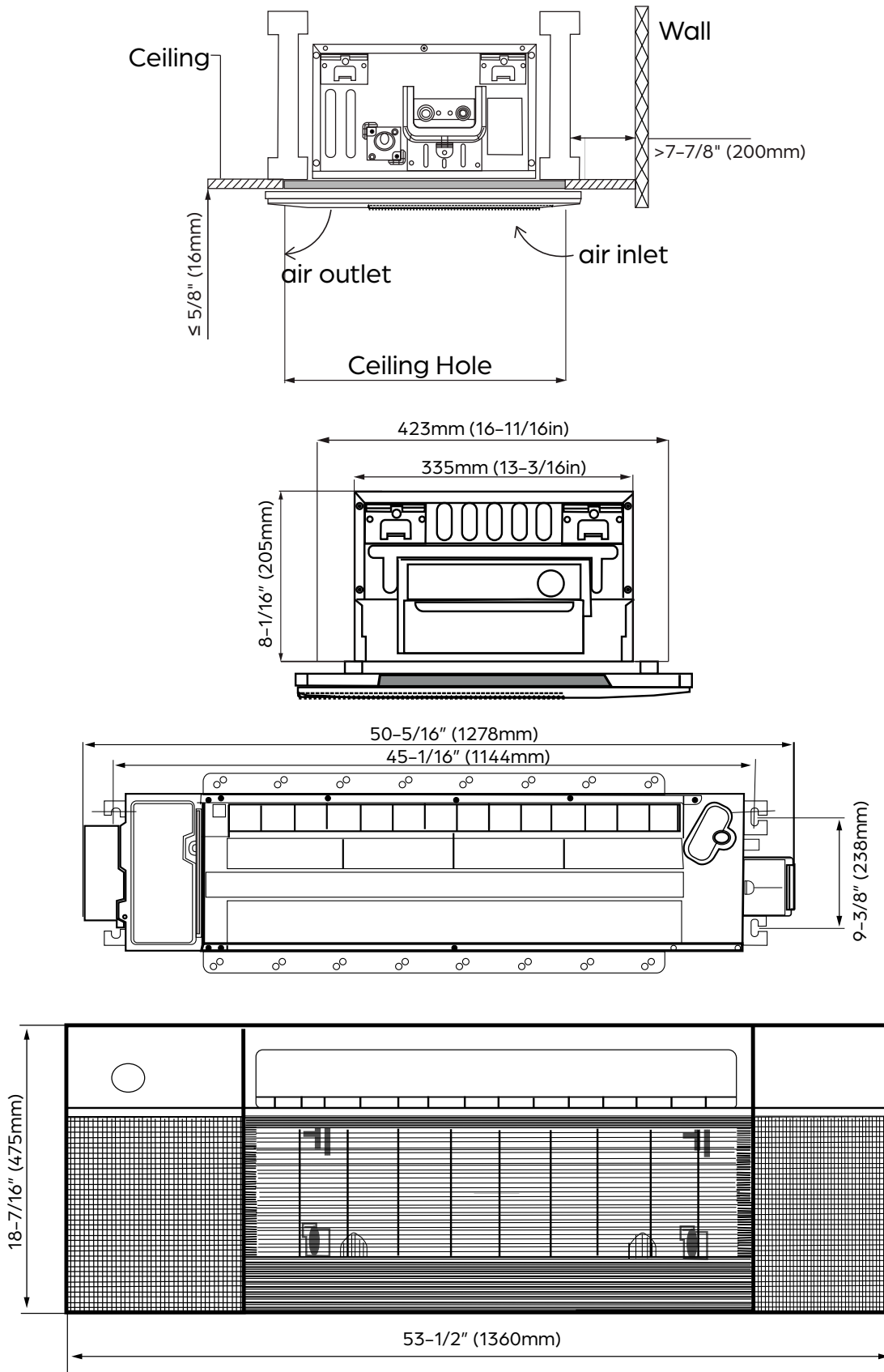



9,000 BTU/H WALL MOUNTED IDU

SUBMITTAL COVER SHEET

PROJECT NAME _____

LOCATION _____

ARCHITECT _____

ENGINEER _____

CONTRACTOR _____

REFERENCE _____

SUBMITTED BY _____ DATE _____

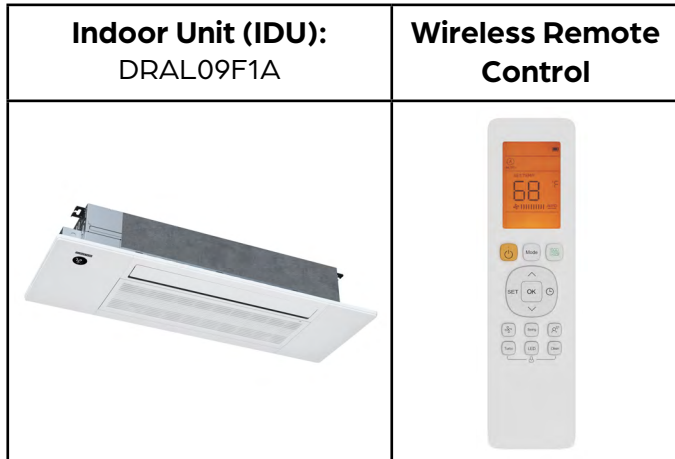

PRODUCT FEATURES

- Single or multi-zone compatible
- Wireless Remote Control with "Follow Me" Technology
- Slim design for easy install between 16" joists
- Serviceable from below
- Washable filter
- Humidity sensor
- Built in drain pump
- Sleep Mode
- Turbo Mode
- 24-Hour Timer Feature
- Quiet operation as low as 31 dB
- High efficiency up to 24 SEER2

SPECIFICATIONS		
Cooling Capacity (BTU/hr)	9000	
Heating Capacity (BTU/hr)	11000	
Voltage/Phase/Frequency	208-230V, 1 Phase, 60 Hz	
Voltage Range	187-253V	
Indoor Unit Air Flow (CFM)	Low	235
	Medium	259
	High	294
Drain Port O.D.	1"	
Drain Port Lift	20.8	
Recommended Breaker (Amps)	15	
Sound Pressure (dB(A))	Low	33
	Medium	36
	High	38
Refrigerant	R410A	

LINE SET REQUIREMENTS	
Connection Type	Flare
Liquid	Ø1/4" (Ø6.35mm)
Gas	Ø3/8" (Ø9.52mm)

DIMENSIONS AND WEIGHT		
Unit Dimensions	Width	50-5/16"
	Depth	13-3/16"
	Height	9"
Carton Dimensions	Width	57-5/8"
	Depth	22-1/2"
	Height	22-1/2"
Net Weight	58.4 lbs.	
Gross Weight	81.3 lbs.	





9,000 BTU/H WALL MOUNTED IDU

IDU DIMENSIONS - DRAL09F1A

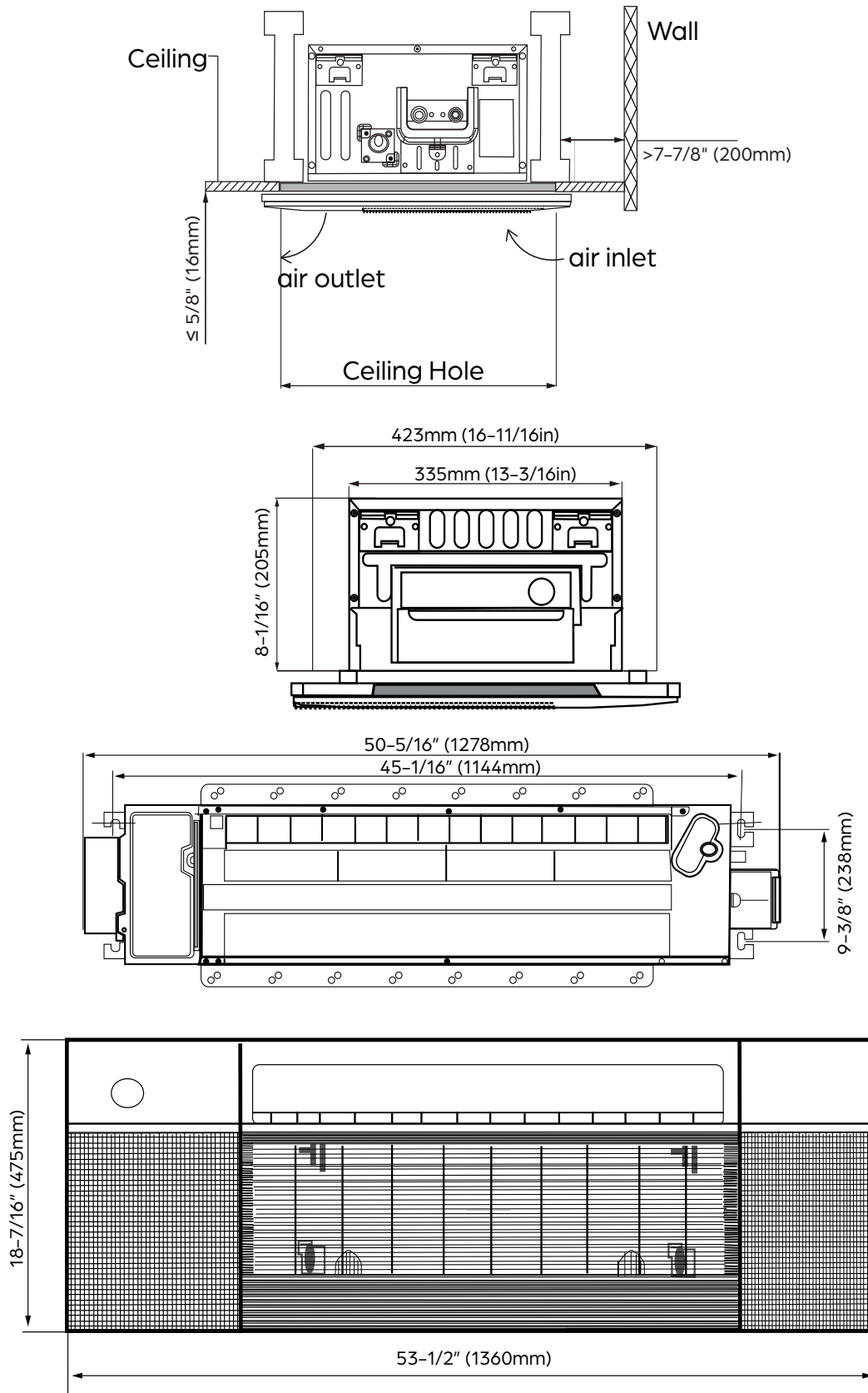



28,000 BTU/H MULTI-ZONE HEAT PUMP SYSTEM

SUBMITTAL COVER SHEET

PROJECT NAME _____

LOCATION _____

ARCHITECT _____

ENGINEER _____

CONTRACTOR _____

REFERENCE _____

SUBMITTED BY _____ DATE _____

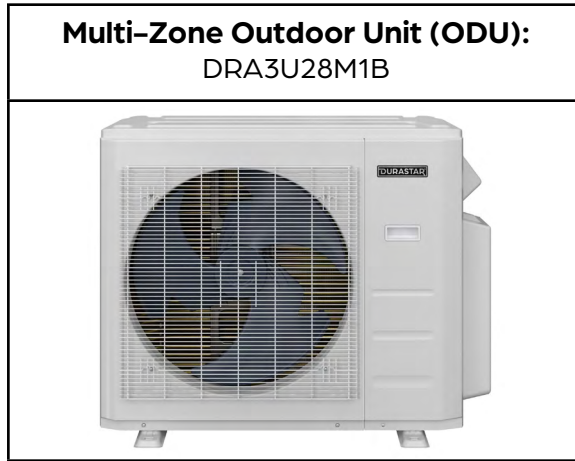

PRODUCT FEATURES

- Variable speed inverter compressor
- Quiet operation
- Low ambient heating down to -13 °F
- Low ambient cooling down to 5 °F
- Included base pan heater
- Auto restart
- Anti-corrosive coil coating
- Port adaptors included

SYSTEM DATA	
Refrigerant Type	R-410A
Refrigerant Charge (oz.)	91.7
Design Pressure (PSIG)	550/340
Outdoor Coil Coating	Golden Fin Coating

CAPACITIES		DUCTLESS	MIXED	DUCTED
Cooling (BTU/hr)	Rated ¹	27000	27000	28000
	at 5 °F ³	21010	21615	22220
	Minimum	8500	8888	9277
	Maximum	32000	31388	30776
Heating (BTU/hr)	Rated ²	28000	28000	28000
	at 5 °F ⁴	17680	16590	15500
	Minimum	8200	8264	8388
	Maximum	35000	31934	28869
Nominal IDU Capacity ⁵ (Min/Max)		15000/36000		

EFFICIENCY DATA	DUCTLESS	MIXED	DUCTED
SEER2	23.50	22.25	21.00
EER2	12.20	11.95	11.70
HSPF2	9.20	9.20	9.20
SEER	22.50	21.75	21.00
EER	12.00	11.60	11.20
HSPF	10.20	10.20	10.20
COP at 47 °F	3.70	3.68	3.66
COP at 5 °F	1.93	1.78	1.62

Specifications are subject to change without notice.
© 2022 Ferguson Enterprises LLC
www.durastar.com





28,000 BTU/H MULTI-ZONE HEAT PUMP SYSTEM

SPECIFICATIONS - DRA3U28M1B

LINE SET REQUIREMENTS	
Connection Type	Flare
Liquid	3 x Ø1/4" (Ø6.35mm)
Gas	3 x Ø3/8" (Ø9.52mm)
Refrigeration Adaptors Included	3 x 3/8"--1/2"
Minimum Indoor Units Connected	2
Pre-Charge Length	22.5'
Maximum Length (combined IDUs)	197'
Maximum Length (per IDU)	98'
Minimum Length (per IDU)	10'
Max. Height Differential between IDU and ODU	49'
Additional Refrigerant for Ø1/4" Liquid Pipe (oz./ft)	0.161

ELECTRICAL DATA	DUCTLESS	DUCTED
Voltage/Phase/Frequency	208-230V, 1 Phase, 60 Hz	
Voltage Range	187-253V	
Recommended Breaker (Amps)	30	
Minimum Circuit Ampacity (Amps)	24.5	
Communication Wire Size	14*4 AWG Stranded	
Rated Current - Cooling (Amps) ¹	11.0	11.5
Rated Current - Heating (Amps) ²	11.0	10.5

¹ Measured at 95 °F.

² Measured at 47 °F.

³ Sensible Capacity: Indoor 80 °F DB, 67 °F WB // Outdoor 5 °F DB, 4 °F WB

⁴ Maximum Capacity: Indoor 70 °F DB, 67 °F WB // Outdoor 5 °F DB, 4 °F WB

⁵ If the total indoor unit load exceeds the nominal capacity of the outdoor unit, the practical output capacity of each indoor unit will be correspondingly reduced. This situation is very evident during heating mode.

OUTDOOR UNIT DATA		
Unit Dimensions	Width	37 1/4"
	Depth	16 1/8"
	Height	31 7/8"
Carton Dimensions	Width	42 15/16"
	Depth	19 11/16"
	Height	34 13/16"
Net Weight	139.8 lbs.	
Gross Weight	150.6 lbs.	
Cooling Operating Temperature	5 °F - 122 °F	
Heating Operating Temperature	-13 °F - 75 °F	
Airflow (CFM)	2129.4	
Sound Pressure (dB(A))	61	
Fan Speed (r/min)	Low	850
	Medium	900
	High	1050
Fan Motor Current Type	DC	

COMPRESSOR	
Type	DC Inverter Twin Cylinder Rotary
Oil Type	VG74
Oil Charge (oz.)	21 (620 ml)



28,000 BTU/H MULTI-ZONE HEAT PUMP SYSTEM

ODU DIMENSIONS - DRA3U28M1B

Clearances

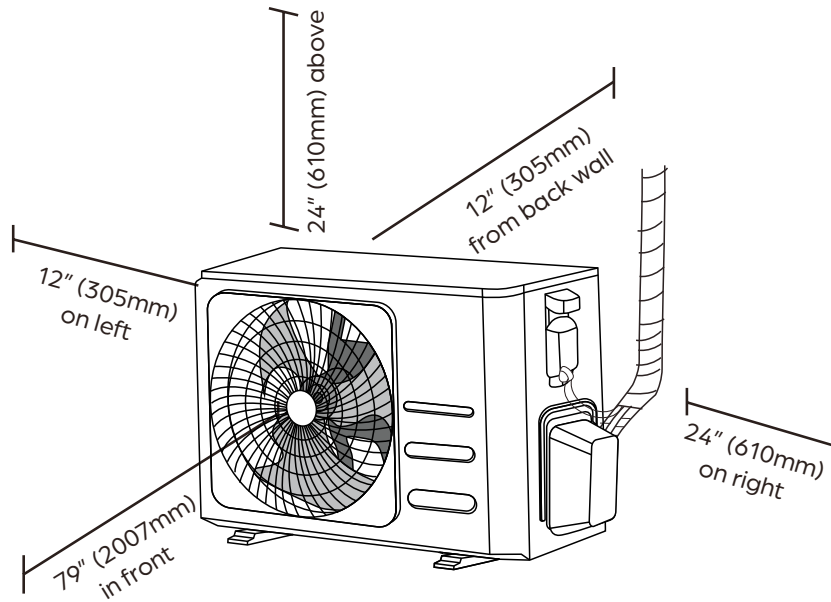

Dimensions

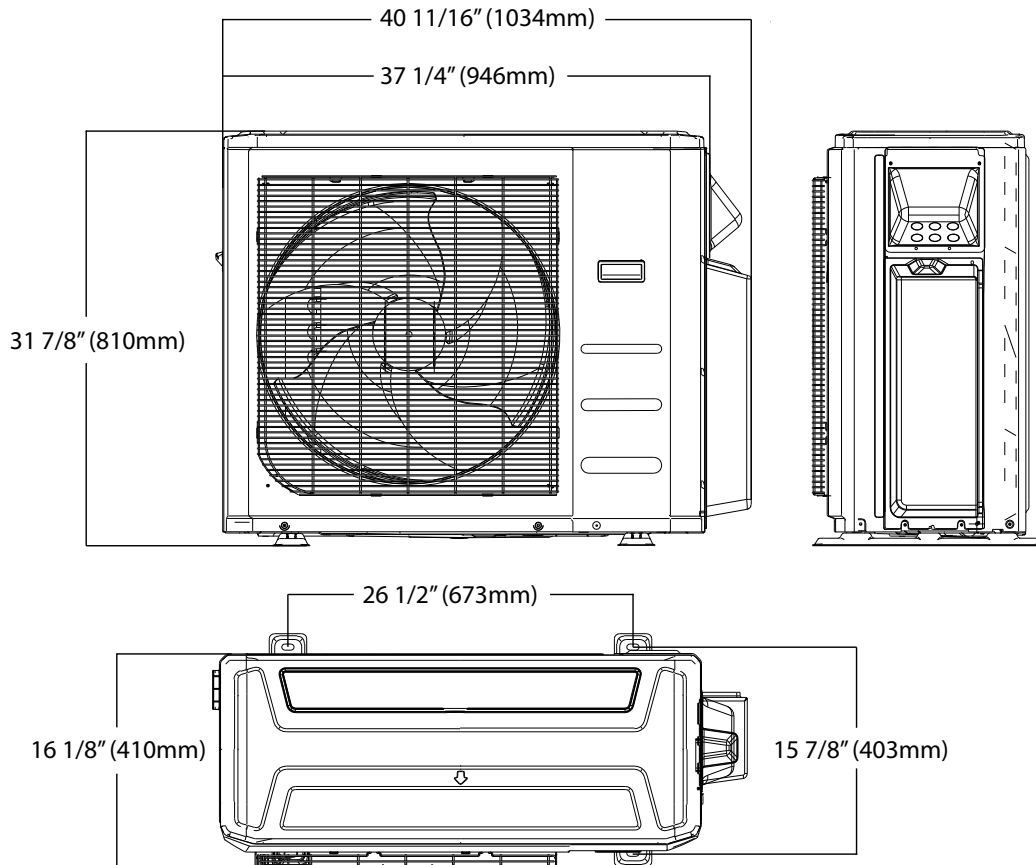

NOTE

Illustrations in this document are for explanatory purposes. The actual shape of your mini-split equipment may vary slightly.