



9,000 BTU/H WALL MOUNTED IDU

SUBMITTAL COVER SHEET

PROJECT NAME _____

LOCATION _____

ARCHITECT _____

ENGINEER _____

CONTRACTOR _____

REFERENCE _____

SUBMITTED BY _____ DATE _____

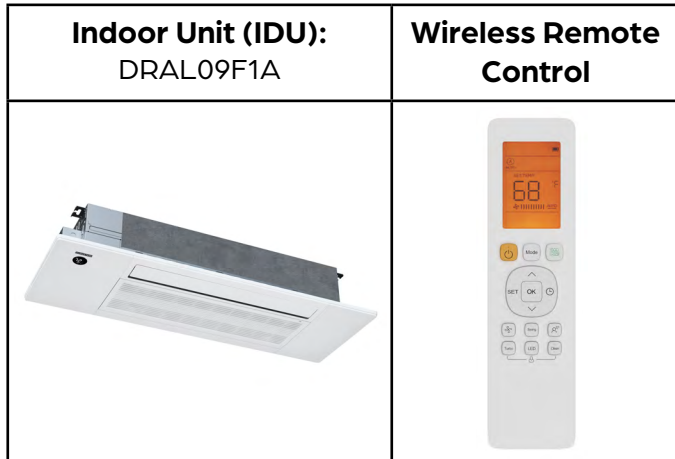

PRODUCT FEATURES

- Single or multi-zone compatible
- Wireless Remote Control with "Follow Me" Technology
- Slim design for easy install between 16" joists
- Serviceable from below
- Washable filter
- Humidity sensor
- Built in drain pump
- Sleep Mode
- Turbo Mode
- 24-Hour Timer Feature
- Quiet operation as low as 31 dB
- High efficiency up to 24 SEER2

SPECIFICATIONS		
Cooling Capacity (BTU/hr)	9000	
Heating Capacity (BTU/hr)	11000	
Voltage/Phase/Frequency	208-230V, 1 Phase, 60 Hz	
Voltage Range	187-253V	
Indoor Unit Air Flow (CFM)	Low	235
	Medium	259
	High	294
Drain Port O.D.	1"	
Drain Port Lift	20.8	
Recommended Breaker (Amps)	15	
Sound Pressure (dB(A))	Low	33
	Medium	36
	High	38
Refrigerant	R410A	

LINE SET REQUIREMENTS	
Connection Type	Flare
Liquid	Ø1/4" (Ø6.35mm)
Gas	Ø3/8" (Ø9.52mm)

DIMENSIONS AND WEIGHT		
Unit Dimensions	Width	50-5/16"
	Depth	13-3/16"
	Height	9"
Carton Dimensions	Width	57-5/8"
	Depth	22-1/2"
	Height	22-1/2"
Net Weight	58.4 lbs.	
Gross Weight	81.3 lbs.	





9,000 BTU/H WALL MOUNTED IDU

IDU DIMENSIONS - DRAL09F1A

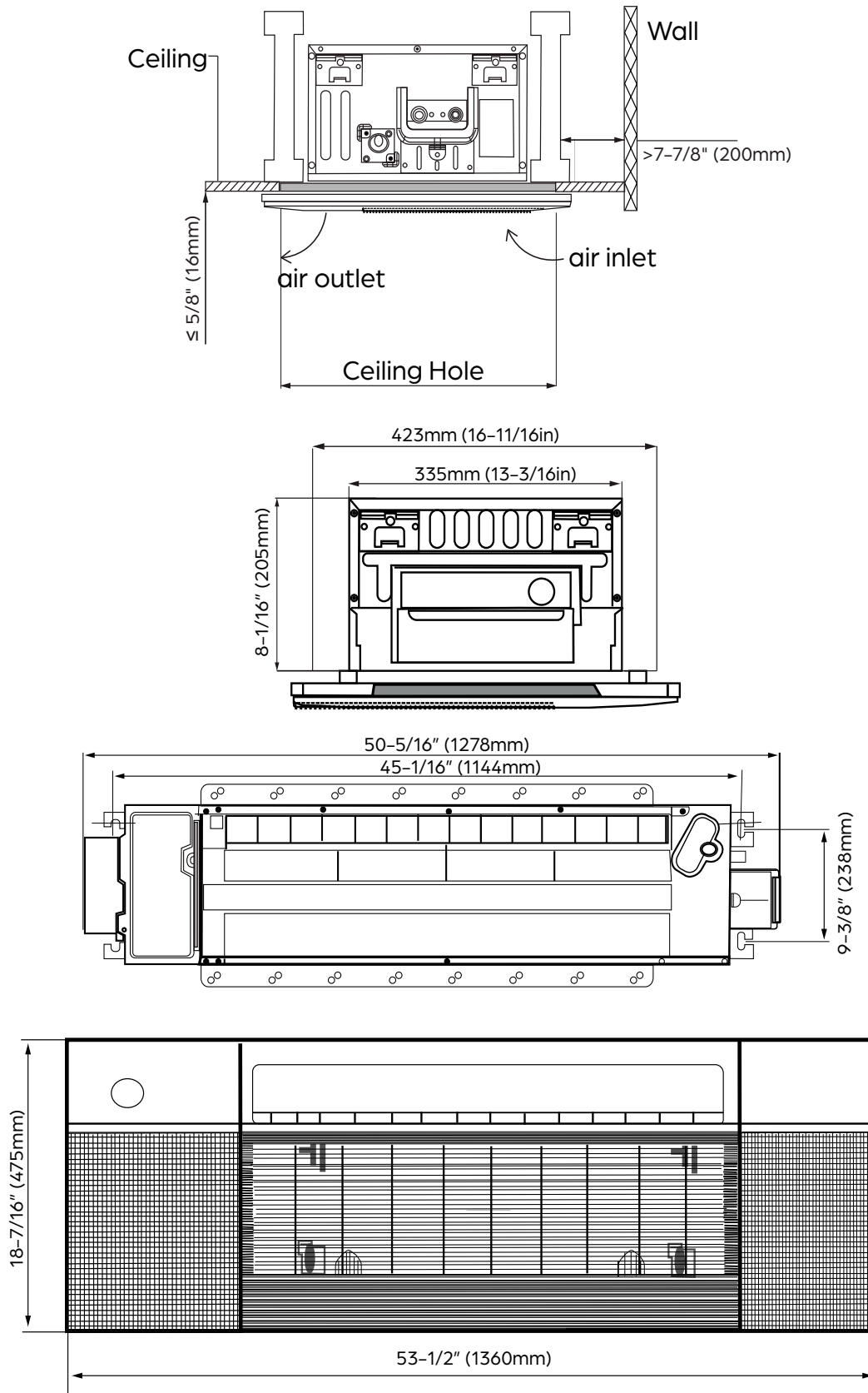



18,000 BTU/H WALL MOUNTED IDU

SUBMITTAL COVER SHEET

PROJECT NAME _____

LOCATION _____

ARCHITECT _____

ENGINEER _____

CONTRACTOR _____

REFERENCE _____

SUBMITTED BY _____ DATE _____

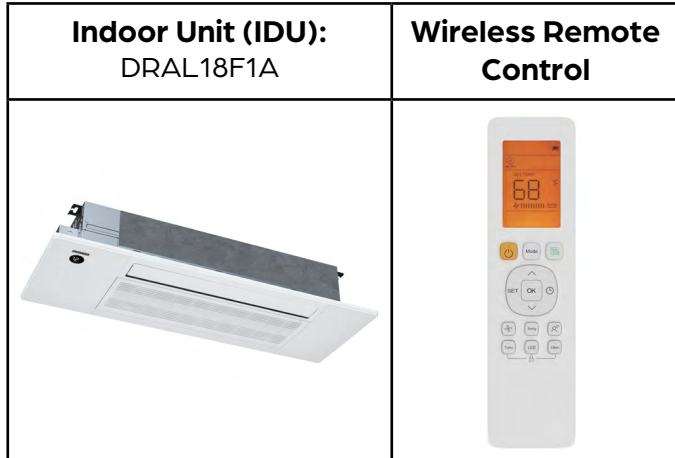

PRODUCT FEATURES

- Single or multi-zone compatible
- Wireless Remote Control with "Follow Me" Technology
- Slim design for easy install between 16" joists
- Serviceable from below
- Washable filter
- Humidity sensor
- Built in drain pump
- Sleep Mode
- Turbo Mode
- 24-Hour Timer Feature
- Quiet operation as low as 35 dB
- High efficiency up to 21 SEER2

SPECIFICATIONS		
Cooling Capacity (BTU/hr)	18000	
Heating Capacity (BTU/hr)	19000	
Voltage/Phase/Frequency	208-230V, 1 Phase, 60 Hz	
Voltage Range	187-253V	
Indoor Unit Air Flow (CFM)	Low	207
	Medium	300
	High	352
Drain Port O.D.	1"	
Drain Port Lift	20.8	
Recommended Breaker (Amps)	15	
Sound Pressure (dB(A))	Low	34
	Medium	41
	High	44
Refrigerant	R410A	

LINE SET REQUIREMENTS	
Connection Type	Flare
Liquid	Ø1/4" (Ø6.35mm)
Gas	Ø1/2" (Ø12.7mm)

DIMENSIONS AND WEIGHT		
Unit Dimensions	Width	50-5/16"
	Depth	13-3/16"
	Height	9"
Carton Dimensions	Width	57-5/8"
	Depth	22-1/2"
	Height	22-1/2"
Net Weight	60.7 lbs.	
Gross Weight	82.9 lbs.	





18,000 BTU/H WALL MOUNTED IDU

IDU DIMENSIONS - DRAL18F1A

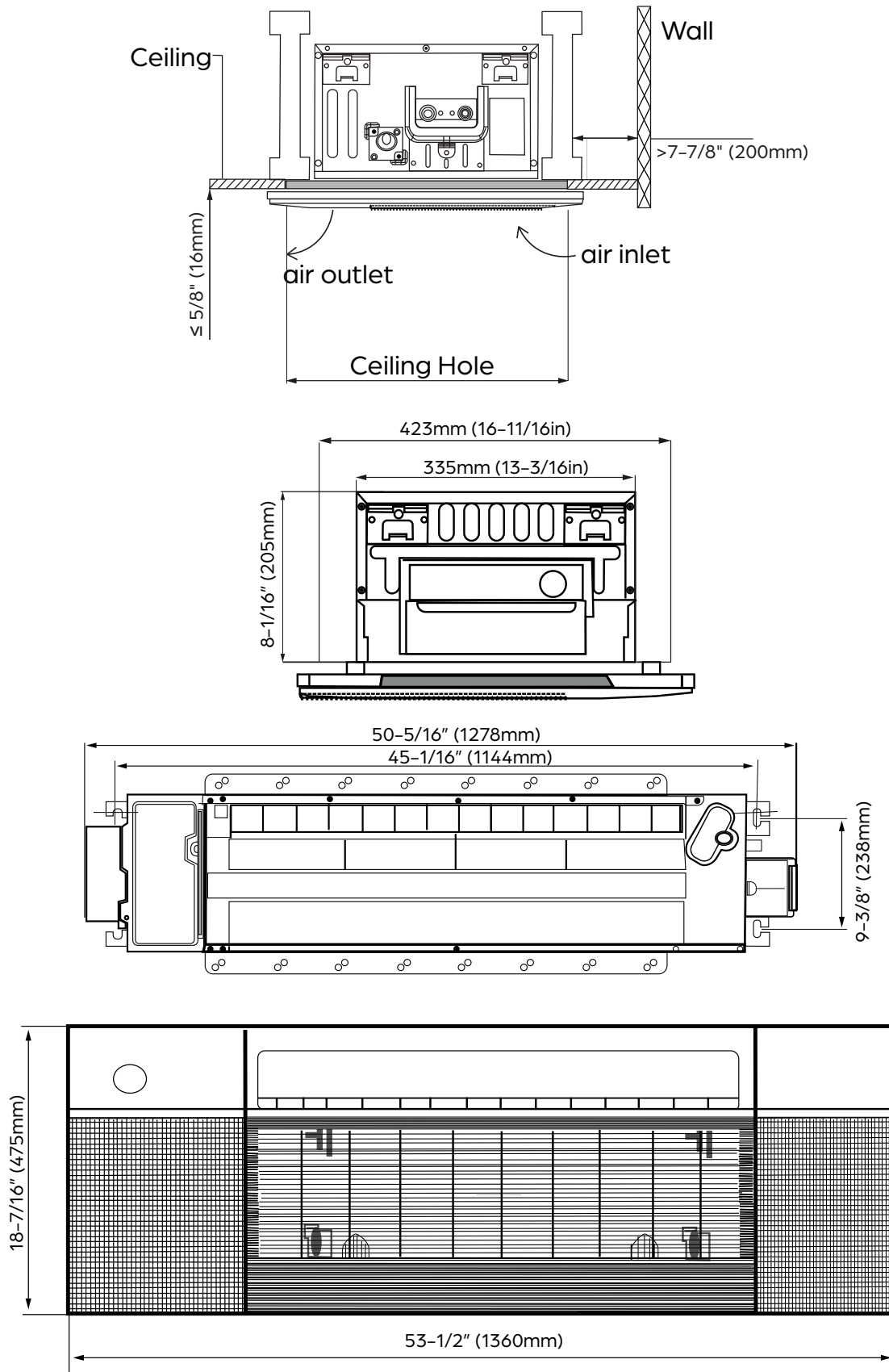



36,000 BTU/H MULTI-ZONE HEAT PUMP SYSTEM

SUBMITTAL COVER SHEET

PROJECT NAME _____

LOCATION _____

ARCHITECT _____

ENGINEER _____

CONTRACTOR _____

REFERENCE _____

SUBMITTED BY _____ DATE _____

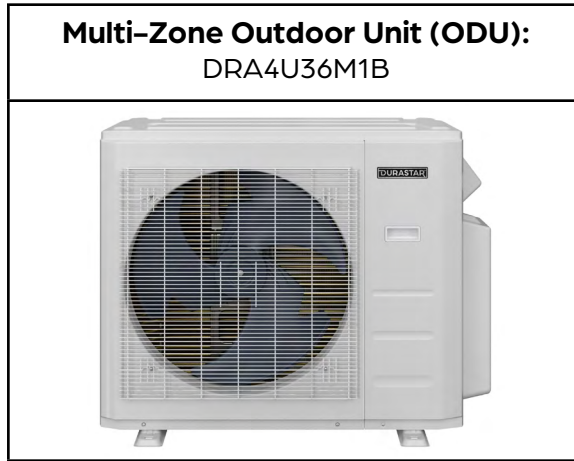

PRODUCT FEATURES

- Variable speed inverter compressor
- Quiet operation
- Low ambient heating down to -13 °F
- Low ambient cooling down to 5 °F
- Included base pan heater
- Auto restart
- Anti-corrosive coil coating
- Port adaptors included

SYSTEM DATA	
Refrigerant Type	R-410A
Refrigerant Charge (oz.)	134.04
Design Pressure (PSIG)	550/340
Outdoor Coil Coating	Golden Fin Coating

CAPACITIES		DUCTLESS	MIXED	DUCTED
Cooling (BTU/hr)	Rated ¹	36000	36000	36000
	at 5 °F ³	29370	29000	28630
	Minimum	9200	8994	8789
	Maximum	40160	40224	40288
Heating (BTU/hr)	Rated ²	37000	37000	37000
	at 5 °F ⁴	24670	24390	24110
	Minimum	8500	7700	6900
	Maximum	46600	46612	46624
Nominal IDU Capacity ⁵ (Min/Max)		18000/48000		

EFFICIENCY DATA	DUCTLESS	MIXED	DUCTED
SEER2	23.10	21.55	20.00
EER2	10.60	10.80	11.00
HSPF2	9.60	9.40	9.20
SEER	21.80	20.65	19.50
EER	10.50	10.75	11.00
HSPF	11.50	11.10	10.70
COP at 47 °F	3.00	3.30	3.60
COP at 5 °F	1.77	1.73	1.68

Specifications are subject to change without notice.
 © 2022 Ferguson Enterprises LLC
 www.durastar.com





36,000 BTU/H MULTI-ZONE HEAT PUMP SYSTEM

SPECIFICATIONS - DRA4U36M1B

LINE SET REQUIREMENTS	
Connection Type	Flare
Liquid	4 x Ø1/4" (Ø6.35mm)
Gas	3 x Ø3/8" (Ø9.52mm) 1 x Ø1/2" (Ø12.7mm)
Refrigeration Adaptors Included	3 x 3/8" -- 1/2" 1 x 1/2" -- 3/8" 1 x 1/4" -- 3/8" 1 x 1/2" -- 5/8"
Minimum Indoor Units Connected	2
Pre-Charge Length	30'
Maximum Length (combined IDUs)	262'
Maximum Length (per IDU)	115'
Minimum Length (per IDU)	10'
Max. Height Differential between IDU and ODU	49'
Additional Refrigerant for Ø1/4" Liquid Pipe (oz./ft)	0.161
Additional Refrigerant for Ø3/8" Liquid Pipe (oz./ft)	0.322

OUTDOOR UNIT DATA		
Unit Dimensions	Width	37 1/4"
	Depth	16 1/8"
	Height	31 7/8"
Carton Dimensions	Width	42 15/16"
	Depth	19 11/16"
	Height	34 13/16"
Net Weight	169 lbs.	
Gross Weight	181 lbs.	
Cooling Operating Temperature	5 °F - 122 °F	
Heating Operating Temperature	-13 °F - 75 °F	
Airflow (CFM)	2147	
Sound Pressure (dB(A))	63	
Fan Speed (r/min)	Low	750
	Medium	900
	High	1000
Fan Motor Current Type	DC	

ELECTRICAL DATA	DUCTLESS		DUCTED	
	Voltage/Phase/Frequency	208-230V, 1 Phase, 60 Hz		
Voltage Range	187-253V			
Recommended Breaker (Amps)	40			
Minimum Circuit Ampacity (Amps)	25			
Communication Wire Size	14*4 AWG Stranded			
Rated Current - Cooling (Amps) ¹	15.4		14.8	
Rated Current - Heating (Amps) ²	15.4		13.0	

COMPRESSOR	
Type	DC Inverter Twin Cylinder Rotary
Oil Type	VG74
Oil Charge (oz.)	33.8 (1000 ml)

¹ Measured at 95 °F.

² Measured at 47 °F.

³ Sensible Capacity: Indoor 80 °F DB, 67 °F WB // Outdoor 5 °F DB, 4 °F WB

⁴ Maximum Capacity: Indoor 70 °F DB, 67 °F WB // Outdoor 5 °F DB, 4 °F WB

⁵ If the total indoor unit load exceeds the nominal capacity of the outdoor unit, the practical output capacity of each indoor unit will be correspondingly reduced. This situation is very evident during heating mode.



38,000 BTU/H MULTI-ZONE HEAT PUMP SYSTEM

ODU DIMENSIONS - DRA4U36M1B

Clearances

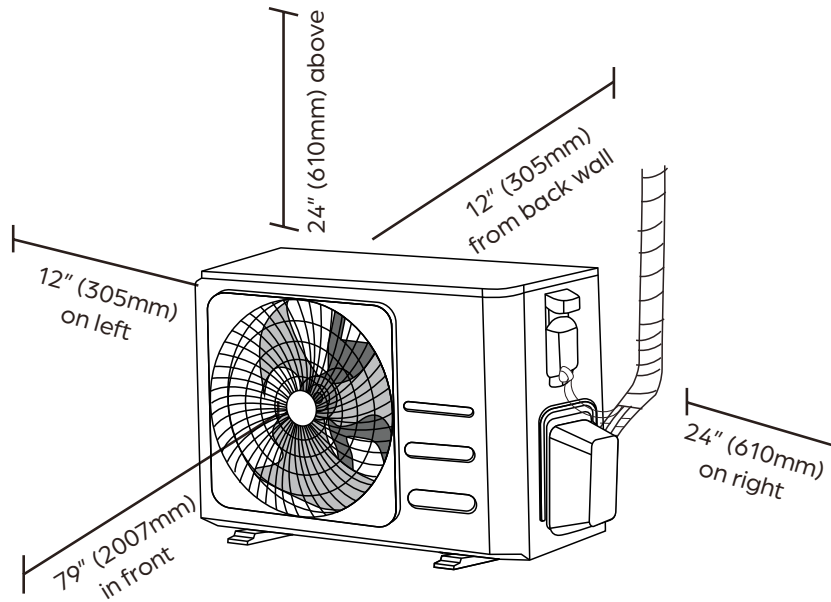

Dimensions

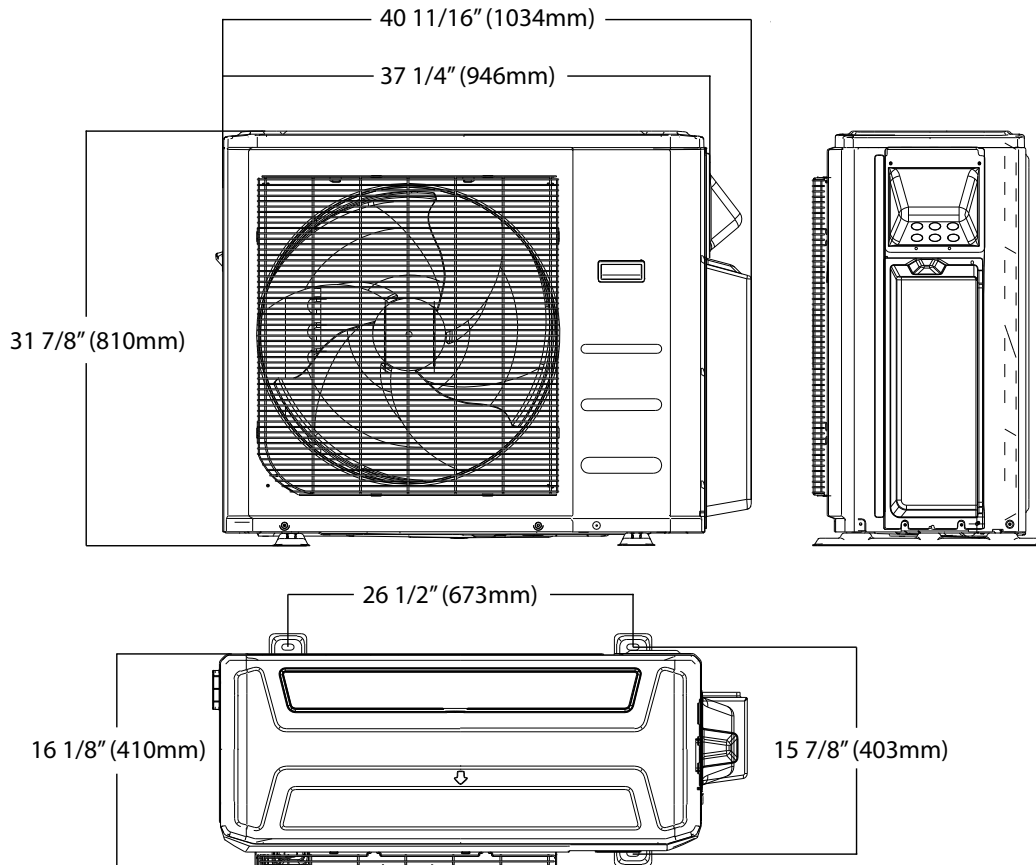

NOTE

Illustrations in this document are for explanatory purposes. The actual shape of your mini-split equipment may vary slightly.