



# 6,000 BTU/H CEILING MOUNTED IDU

SUBMITTAL COVER SHEET

PROJECT NAME \_\_\_\_\_

LOCATION \_\_\_\_\_

ARCHITECT \_\_\_\_\_

ENGINEER \_\_\_\_\_

CONTRACTOR \_\_\_\_\_

REFERENCE \_\_\_\_\_

SUBMITTED BY \_\_\_\_\_ DATE \_\_\_\_\_

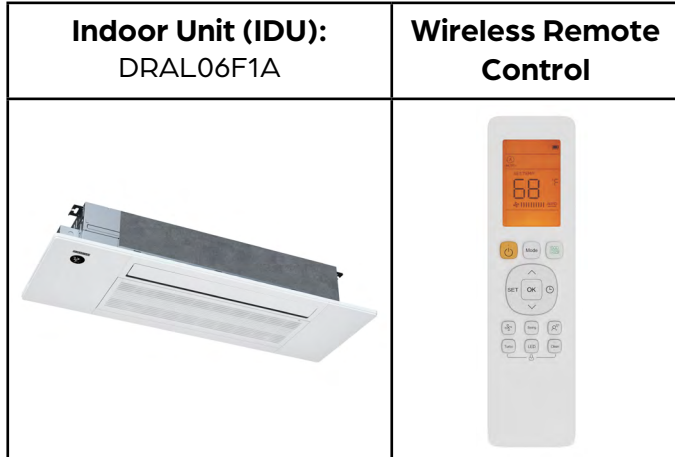

### PRODUCT FEATURES

- Single or multi-zone compatible
- Wireless Remote Control with "Follow Me" Technology
- Slim design for easy install between 16" joists
- Serviceable from below
- Washable filter
- Humidity sensor
- Built in drain pump
- Sleep Mode
- Turbo Mode
- 24-Hour Timer Feature
- Quiet operation as low as 32.5 dB
- High efficiency up to 22 SEER2

SPECIFICATIONS		
Cooling Capacity (BTU/hr)	6500	
Heating Capacity (BTU/hr)	7100	
Voltage/Phase/Frequency	208-230V, 1 Phase, 60 Hz	
Voltage Range	187-253V	
Indoor Unit Air Flow (CFM)	Low	235
	Medium	259
	High	294
Drain Port O.D.	1"	
Drain Port Lift	20.8	
Recommended Breaker (Amps)	15	
Sound Pressure (dB(A))	Low	32.5
	Medium	35.5
	High	37.5
Refrigerant	R410A	

LINE SET REQUIREMENTS	
Connection Type	Flare
Liquid	Ø1/4" (Ø6.35mm)
Gas	Ø3/8" (Ø9.52mm)

DIMENSIONS AND WEIGHT		
Unit Dimensions	Width	50-5/16"
	Depth	13-3/16"
	Height	9"
Carton Dimensions	Width	57-5/8"
	Depth	22-1/2"
	Height	22-1/2"
Net Weight	58.4 lbs.	
Gross Weight	81.3 lbs.	





# 6,000 BTU/H CEILING MOUNTED IDU

IDU DIMENSIONS - DRAL06F1A

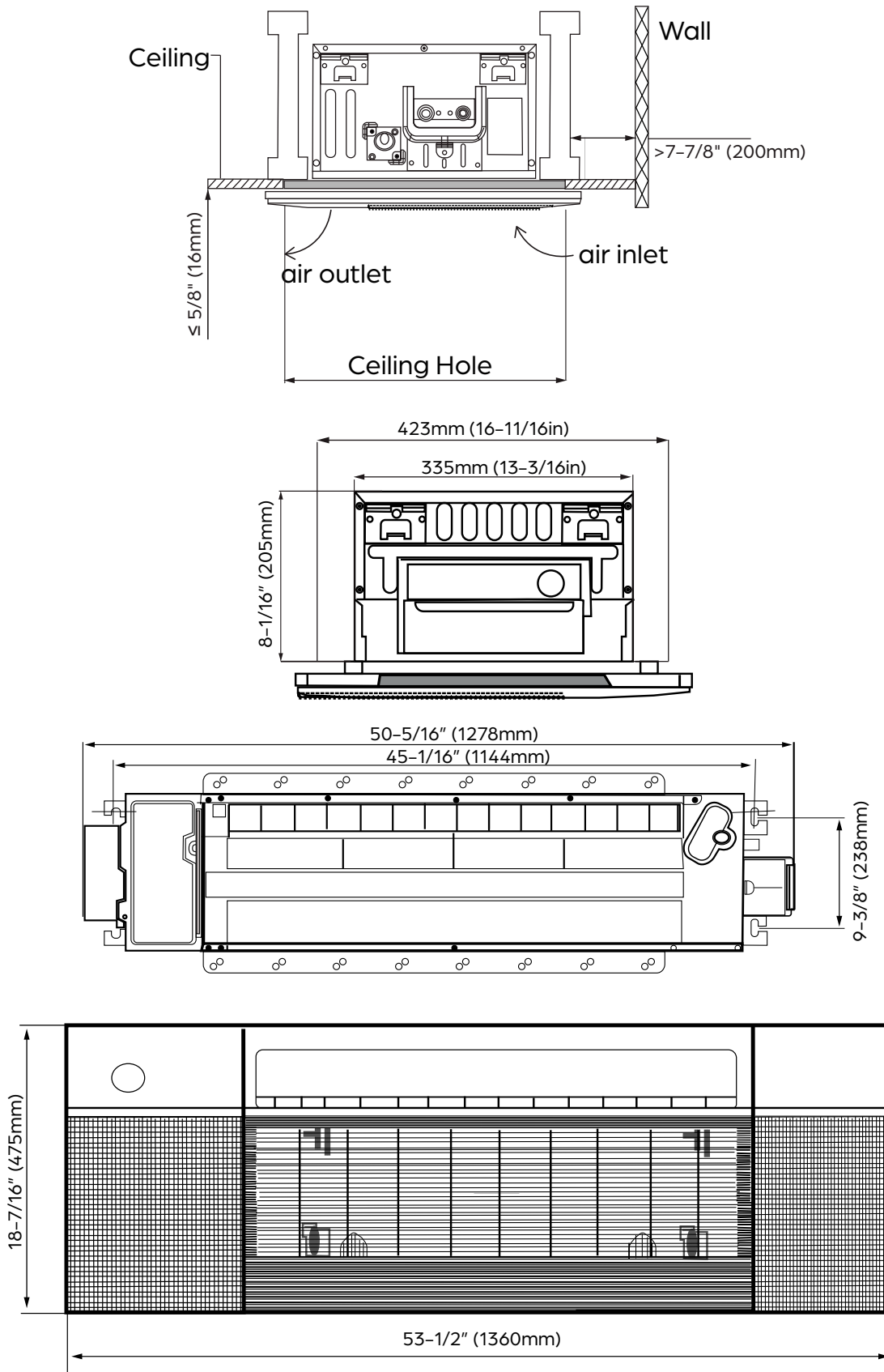



# 9,000 BTU/H WALL MOUNTED IDU

SUBMITTAL COVER SHEET

PROJECT NAME \_\_\_\_\_

LOCATION \_\_\_\_\_

ARCHITECT \_\_\_\_\_

ENGINEER \_\_\_\_\_

CONTRACTOR \_\_\_\_\_

REFERENCE \_\_\_\_\_

SUBMITTED BY \_\_\_\_\_ DATE \_\_\_\_\_

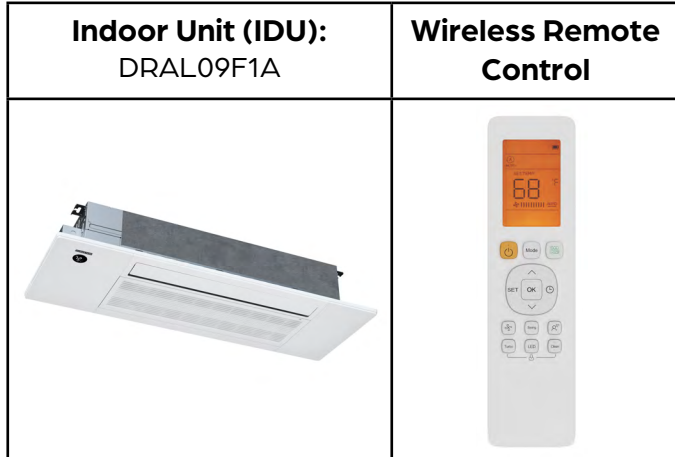

### PRODUCT FEATURES

- Single or multi-zone compatible
- Wireless Remote Control with "Follow Me" Technology
- Slim design for easy install between 16" joists
- Serviceable from below
- Washable filter
- Humidity sensor
- Built in drain pump
- Sleep Mode
- Turbo Mode
- 24-Hour Timer Feature
- Quiet operation as low as 31 dB
- High efficiency up to 24 SEER2

SPECIFICATIONS		
Cooling Capacity (BTU/hr)	9000	
Heating Capacity (BTU/hr)	11000	
Voltage/Phase/Frequency	208-230V, 1 Phase, 60 Hz	
Voltage Range	187-253V	
Indoor Unit Air Flow (CFM)	Low	235
	Medium	259
	High	294
Drain Port O.D.	1"	
Drain Port Lift	20.8	
Recommended Breaker (Amps)	15	
Sound Pressure (dB(A))	Low	33
	Medium	36
	High	38
Refrigerant	R410A	

LINE SET REQUIREMENTS	
Connection Type	Flare
Liquid	Ø1/4" (Ø6.35mm)
Gas	Ø3/8" (Ø9.52mm)

DIMENSIONS AND WEIGHT		
Unit Dimensions	Width	50-5/16"
	Depth	13-3/16"
	Height	9"
Carton Dimensions	Width	57-5/8"
	Depth	22-1/2"
	Height	22-1/2"
Net Weight	58.4 lbs.	
Gross Weight	81.3 lbs.	





# 9,000 BTU/H WALL MOUNTED IDU

IDU DIMENSIONS - DRAL09F1A

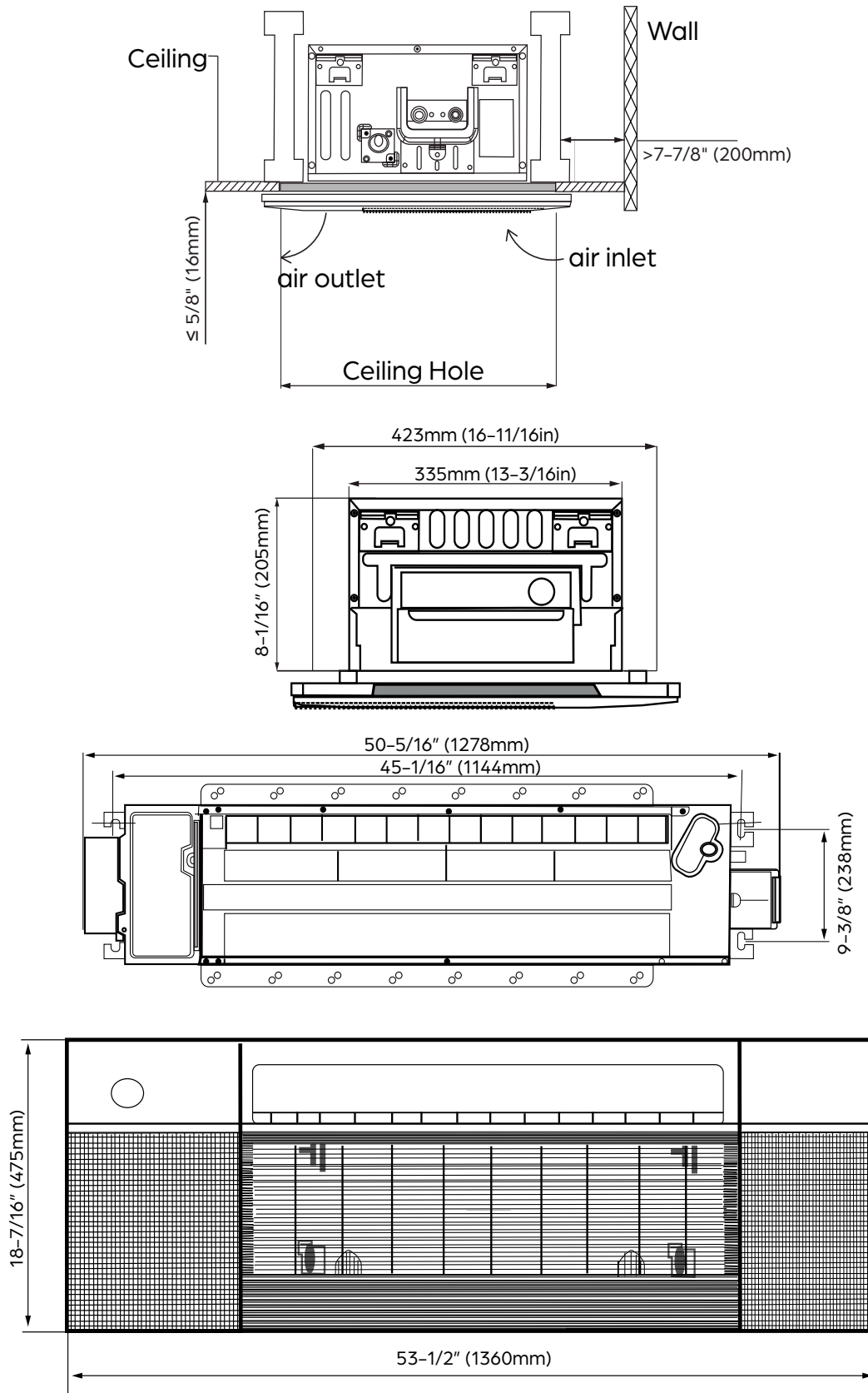



# 12,000 BTU/H WALL MOUNTED IDU

SUBMITTAL COVER SHEET

PROJECT NAME \_\_\_\_\_

LOCATION \_\_\_\_\_

ARCHITECT \_\_\_\_\_

ENGINEER \_\_\_\_\_

CONTRACTOR \_\_\_\_\_

REFERENCE \_\_\_\_\_

SUBMITTED BY \_\_\_\_\_ DATE \_\_\_\_\_

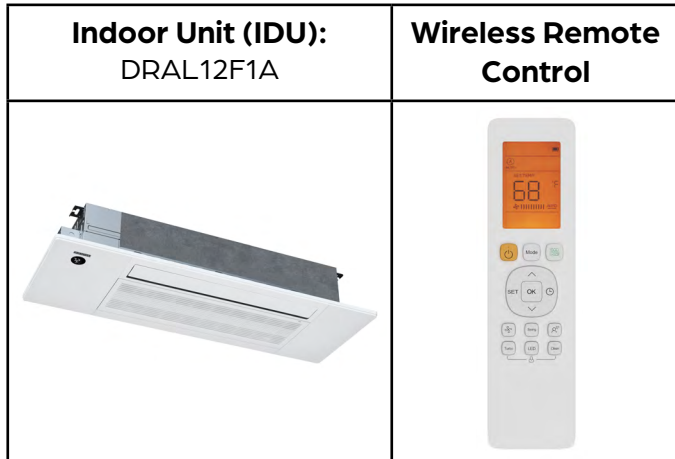

### PRODUCT FEATURES

- Single or multi-zone compatible
- Wireless Remote Control with "Follow Me" Technology
- Slim design for easy install between 16" joists
- Serviceable from below
- Washable filter
- Humidity sensor
- Built in drain pump
- Sleep Mode
- Turbo Mode
- 24-Hour Timer Feature
- Quiet operation as low as 32.5 dB
- High efficiency up to 23 SEER2

SPECIFICATIONS		
Cooling Capacity (BTU/hr)	12000	
Heating Capacity (BTU/hr)	12500	
Voltage/Phase/Frequency	208-230V, 1 Phase, 60 Hz	
Voltage Range	187-253V	
Indoor Unit Air Flow (CFM)	Low	247
	Medium	282
	High	312
Drain Port O.D.	1"	
Drain Port Lift	20.8	
Recommended Breaker (Amps)	15	
Sound Pressure (dB(A))	Low	34.5
	Medium	38.5
	High	40.5
Refrigerant	R410A	

LINE SET REQUIREMENTS	
Connection Type	Flare
Liquid	Ø1/4" (Ø12.70mm)
Gas	Ø1/2" (Ø9.52mm)

DIMENSIONS AND WEIGHT		
Unit Dimensions	Width	50-5/16"
	Depth	13-3/16"
	Height	9"
Carton Dimensions	Width	57-5/8"
	Depth	22-1/2"
	Height	22-1/2"
Net Weight	60.7 lbs.	
Gross Weight	82.9 lbs.	





# 12,000 BTU/H WALL MOUNTED IDU

IDU DIMENSIONS - DRAL12F1A

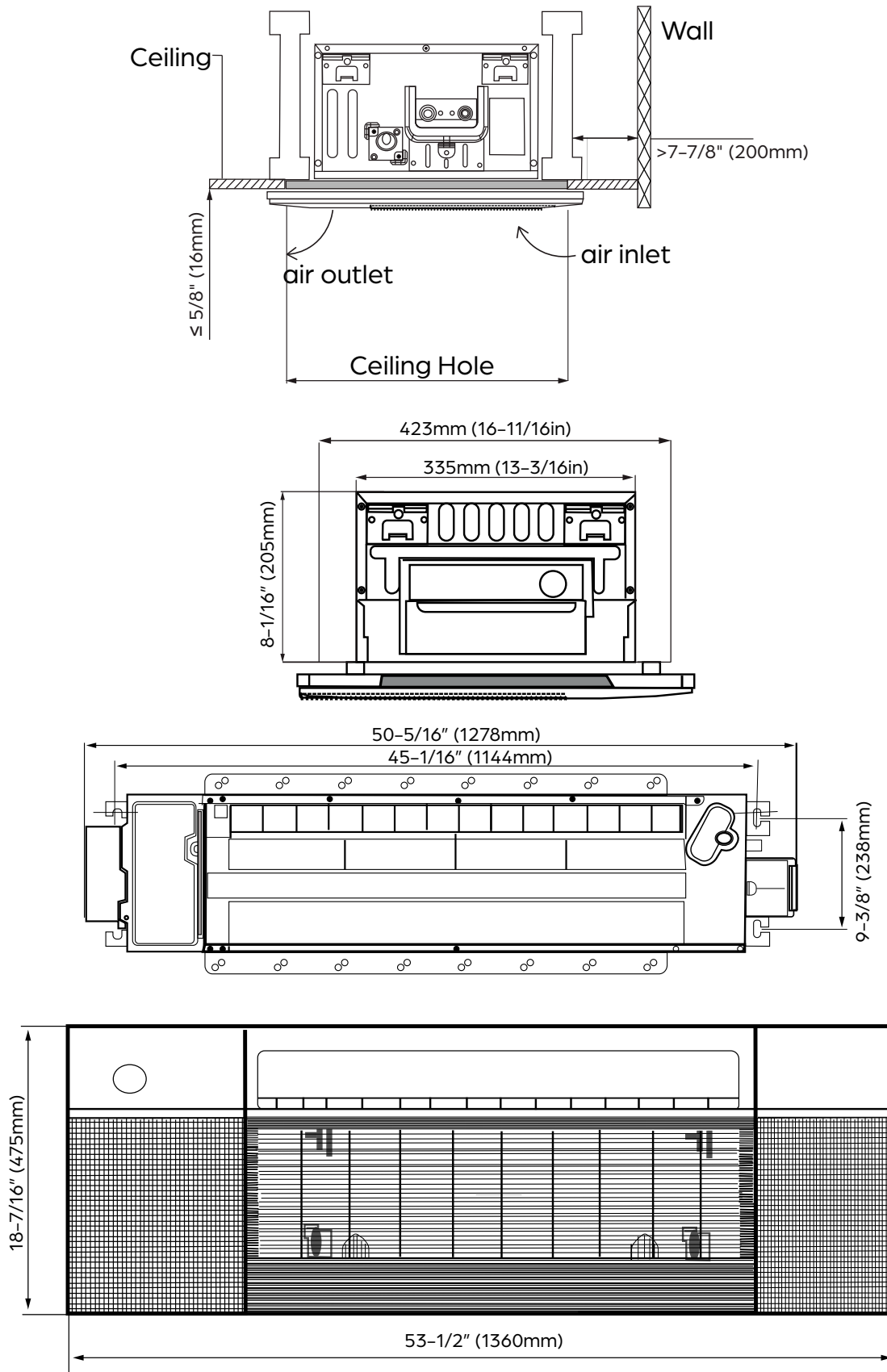



**SIRIUS HEAT™**

# 36,000 BTU/H SIRIUS HEAT MULTI-ZONE HEAT PUMP

SUBMITTAL COVER SHEET

PROJECT NAME \_\_\_\_\_

LOCATION \_\_\_\_\_

ARCHITECT \_\_\_\_\_

ENGINEER \_\_\_\_\_

CONTRACTOR \_\_\_\_\_

REFERENCE \_\_\_\_\_

SUBMITTED BY \_\_\_\_\_ DATE \_\_\_\_\_



### PRODUCT FEATURES

- High heating capacity at 0°F
- Variable speed inverter compressor
- Low ambient heating down to -22°F
- Low ambient cooling down to 5°F
- Quiet operation
- Included base pan heater
- Auto restart
- Anti-corrosive coil coating
- Port adaptors included

SYSTEM DATA	
Refrigerant Type	R-410A
Refrigerant Charge (oz.)	162
Design Pressure (PSIG)	550/340
Outdoor Coil Coating	Golden Fin Coating

CAPACITIES		DUCTLESS	MIXED	DUCTED
Cooling (BTU/hr)	Rated <sup>1</sup>	36000	36000	36000
	at 5°F <sup>3</sup>	29900	29550	29200
	Minimum	15600	16500	17400
	Maximum	41900	42950	44000
	Heating (BTU/hr)	Rated <sup>2</sup>	36000	36500
	at 5°F <sup>4</sup>	36000	34500	33000
	Minimum	20000	13650	13300
	Maximum	50300	48650	47000
Nominal ODU Capacity <sup>5</sup>		36000		

EFFICIENCY DATA	DUCTLESS	MIXED	DUCTED
SEER2	20.00	19.50	19.00
EER2	12.50	12.10	11.70
HSPF2	9.70	9.85	10.00
SEER	20.00	19.50	19.00
EER	12.50	11.90	11.30
HSPF	10.80	10.90	11.00
COP at 47 °F	3.52	3.63	3.74
COP at 5 °F	1.90	1.80	1.70



Specifications are subject to change without notice.  
 © 2023 Ferguson Enterprises LLC  
 www.durastar.com



**SIRIUS HEAT™**

# 36,000 BTU/H SIRIUS HEAT MULTI-ZONE HEAT PUMP

SPECIFICATIONS - DRA4H36M1A

LINE SET REQUIREMENTS	
Connection Type	Flare
Liquid	4 x Ø1/4" (Ø6.35mm)
Gas	3 x Ø3/8" (Ø9.52mm) 1 x Ø1/2" (Ø12.7mm)
Refrigeration Adaptors Included	3 x 3/8" -- 1/2" 1 x 1/2" -- 3/8" 1 x 1/4" -- 3/8" 1 x 1/2" -- 5/8"
Minimum Indoor Units Connected	2
Pre-Charge Length	98'
Maximum Length (combined IDUs)	262'
Maximum Length (per IDU)	115'
Minimum Length (per IDU)	10'
Max. Height Differential between IDU and ODU	49'
Max. Height Differential between IDUs	33'
Additional Refrigerant for Ø1/4" Liquid Pipe (oz./ft)	0.161
Additional Refrigerant for Ø3/8" Liquid Pipe (oz./ft)	0.322

OUTDOOR UNIT DATA		
Unit Dimensions	Width	37-1/2"
	Depth	16-5/16"
	Height	52-1/2"
Carton Dimensions	Width	43-1/8"
	Depth	19-1/2"
	Height	58-1/4"
Net Weight	223 lbs.	
Gross Weight	254 lbs.	
Cooling Operating Temperature	5°F - 122°F	
Heating Operating Temperature	-22°F - 75°F	
Airflow (CFM)	4500	
Sound Pressure (dB(A))	62	
Fan Speed (r/min)	Low	750
	Medium	800
	Medium	850
	High	900
Fan Motor Current Type	DC	

ELECTRICAL DATA	DUCTLESS		DUCTED	
	Voltage/Phase/Frequency	208-230V, 1 Phase, 60 Hz		
Voltage Range	187-253V			
Recommended Breaker (Amps)	60			
Minimum Circuit Ampacity (Amps)	40			
Communication Wire Size	14*4 AWG Stranded			
Rated Current - Cooling (Amps) <sup>1</sup>	13.2	14.2		
Rated Current - Heating (Amps) <sup>2</sup>	13.7	12.9		

COMPRESSOR	
Type	DC Inverter Twin Cylinder Rotary
Oil Type	VG74
Oil Charge (oz.)	47 (1400 mL)

<sup>1</sup> AHRI Rated at 95°F (AFull).

<sup>2</sup> AHRI Rated at 47°F (H1Full).

<sup>3</sup> Sensible Capacity: Indoor 80°F DB, 67°F WB // Outdoor 5°F DB, 4°F WB

<sup>4</sup> AHRI Rated Capacity at 5°F (H42)

<sup>5</sup> If the total indoor unit load exceeds the nominal capacity of the outdoor unit, the practical output capacity of each indoor unit will be correspondingly reduced. This situation is very evident during heating mode.



**Clearances**

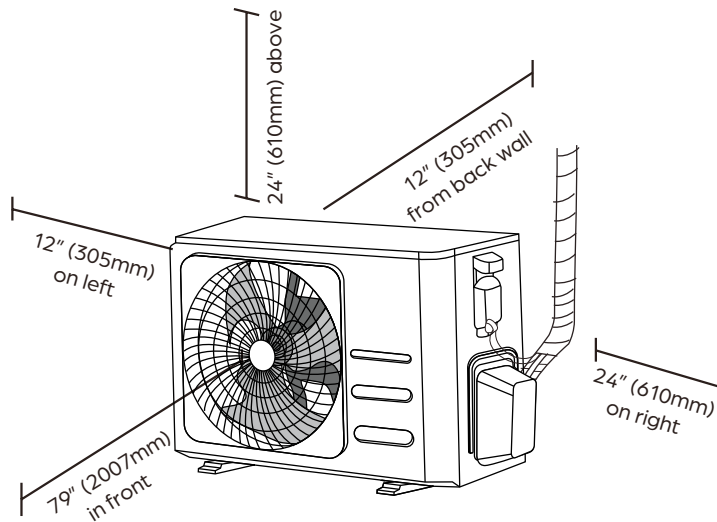

**Dimensions**

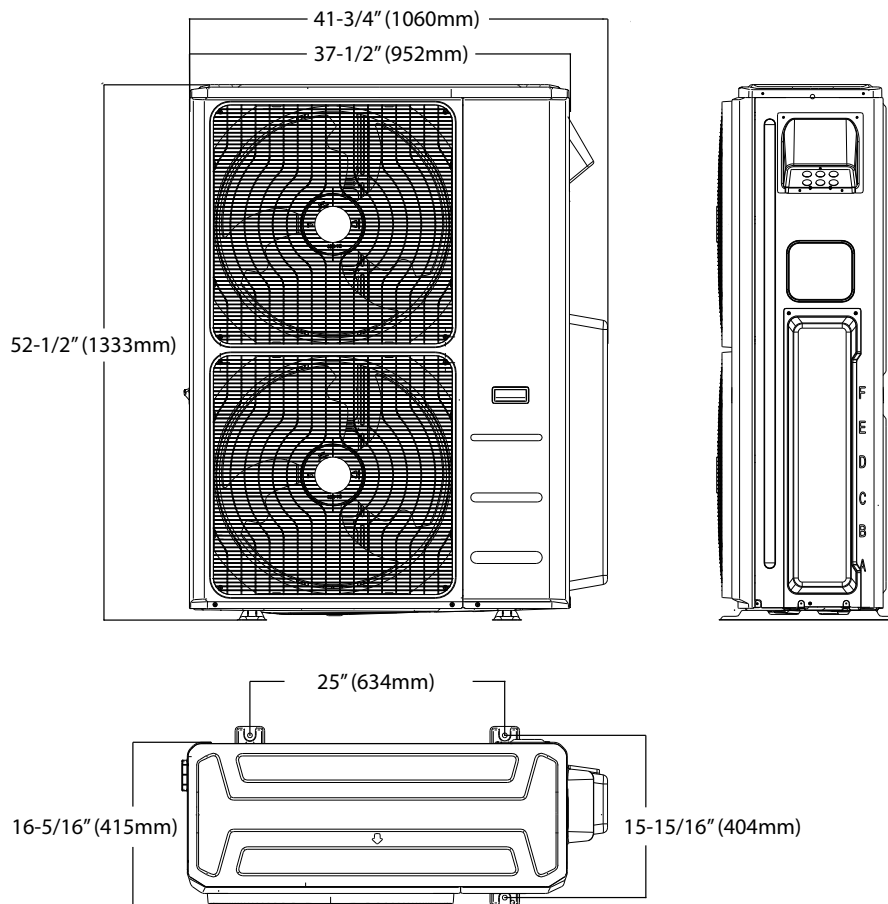

**NOTE**

- Illustrations in this document are for explanatory purposes. The actual shape of your mini-split equipment may vary slightly.