



T6 Pro Z-Wave Programmable Thermostat TH6320ZW

Professional Install Guide

.....

Package Includes:

- T6 PRO Z-Wave Thermostat
 - UWP™ Mounting System
 - Standard Installation Adapter (J-box adapter)
 - Decorative Cover Plate – Small; Size 4-49/64 in = 121mm.
 - Screws and anchors
 - 3 AA batteries
 - Professional Install Guide
 - Getting Started Guide
-



**TH6320ZW2003 depicted.
Actual size 4.09" x 4.09" x 1.06"*



Compatibility

- Designed for battery operation (3 x AA batteries) or for 24 VAC power operation (via a "C" or common wire).
- Compatible with most single and multi-stage conventional and heat pump systems.
- Designed to work with any Z-Wave compliant controller or gateway; however, a security enabled Z-Wave Plus Controller is recommended to fully utilize all thermostat features.
- Works with millivolt systems.
- Does not work with electric baseboard heat (120-240V).

User Guide

Visit honeywellhome.com for a complete user guide.

Customer assistance

For assistance with this product, please visit customer.resideo.com.
Or call Resideo Customer Care toll-free at **1-800-468-1502**.



33-00294-07

Read and save these instructions.

Introduction

The T6 Pro Z-Wave Programmable Thermostat is a Z-Wave Plus certified thermostat capable of controlling up to three heat and two cool stages of heat pump, (incl. dual fuel heat pump systems) and up to two heat and two cool stages of conventional system (3H/2C HP, 2H/2C Conv.) It also measures, displays and reports % indoor relative humidity; however, this model does not control humidification equipment.

It is one of the easiest smart thermostats to install and is controllable by all Z-Wave compliant controllers that have the control capability for "Thermostat" devices. When integrated with the app that controls your Z-Wave controller, it lets you program and control your home's HVAC system as well as controlling other Z-Wave devices connected to the same Z-Wave controller.

Because the thermostat is battery-powered, low-voltage integrators can easily connect the thermostat to most HVAC systems. Optional 24 VAC powering via "C" or common wire is also available, if desired.



CAUTION

- We strongly recommend that installation is performed by a trained HVAC technician.
- Read the enclosed instructions carefully before installing the new T6 Pro Z-Wave Programmable Thermostat.
- **ELECTRICAL HAZARD:** Can cause electrical shock or equipment damage. Disconnect power before beginning installation.
- To prevent abnormal operation, it is highly recommended to configure the installer setup and set the thermostat to correct HVAC system before including the thermostat to Z-Wave network. If the configuration must be changed, first **EXCLUDE** the thermostat from the network, change the thermostat configuration, and **INCLUDE** the thermostat back to the network.
- Before disconnecting wires from the existing thermostat, label the wires with the terminal markings from the old thermostat and record them. Take a picture of the old wiring.
- Use 3 new AA batteries in the thermostat.

UWP Mounting System installation

1. Open package to find the UWP. See Figure 1.
2. Position the UWP on the wall. Level and mark hole positions. See Figure 2.
Drill holes at marked positions, and then lightly tap supplied wall anchors into wall using a hammer.
- Drill 7/32" holes for drywall.
3. Pull the door open and insert wires through wiring hole of the UWP. See Figure 3.
4. Place the UWP over the wall anchors. Insert and tighten mounting screws supplied with the UWP. Do not overtighten. Tighten until the UWP no longer moves. Close the door. See Figure 4.

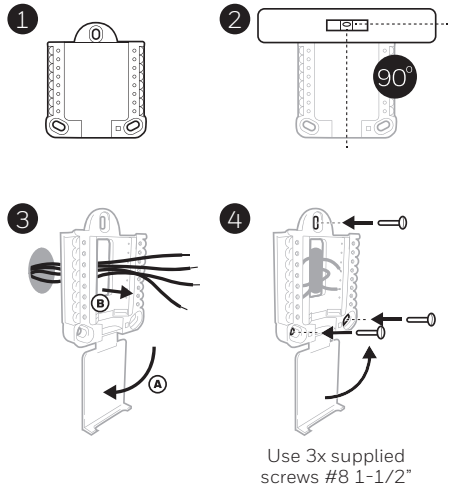

Optional Decorative Cover Plate installation

Use the **Optional Cover Plate** when:

- Mounting the thermostat to an electrical junction box
 - Or when you need to cover paint gap from the old thermostat.
5. Separate the Junction Box Adapter from the Cover Plate. See Figure 5.
 6. Mount the Junction Box Adapter to the wall or an electrical box using any of the eight screw holes. Insert and tighten mounting screws supplied with Cover Plate Kit. Do not overtighten. Make sure the Adapter Plate is level. See Figure 6.
 7. Attach the UWP by hanging it on the top hook of the Junction Box Adapter and then snapping the bottom of the UWP in place. See Figure 7.
 8. Snap the Cover Plate onto the Junction Box Adapter. See Figure 8.

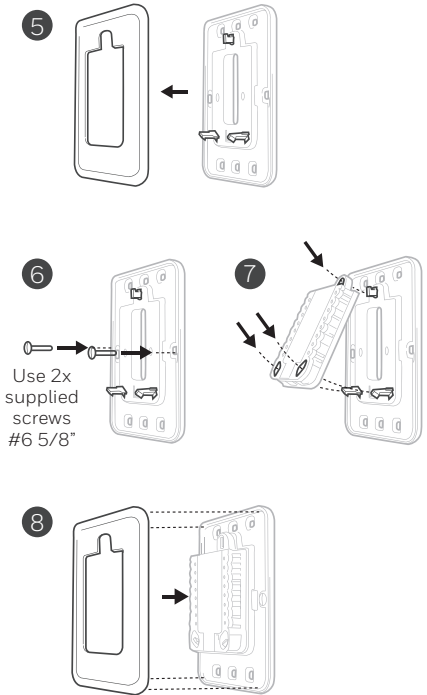

Power options

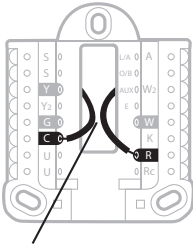

Insert **R** and **C** wires into designated terminals for primary AC power (C terminal is optional if batteries are installed, but it is recommended). Remove wires by depressing the terminal tabs.

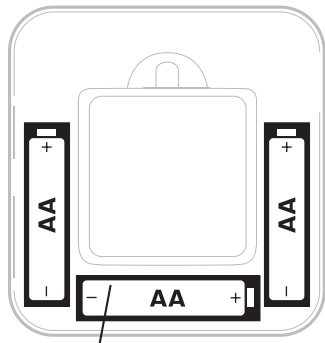

Insert 3 AA batteries for primary or backup power. Match the polarity of the batteries with the + / - marks inside the battery compartment.

NOTES:

- The T6 Pro Z-Wave thermostat works in battery mode or normal power mode based on its power source. The Z-Wave power mode can only be changed when the thermostat is NOT included in a Z-Wave network. You can check the power mode in the thermostat menu under **MENU/DEVICE INFO**.
- If a C wire is not used or present, the thermostat must be powered by batteries. The thermostat will operate in LSS mode (power-save, sleep mode) to help conserve battery life after it has been included in a Z-Wave network. The Z-Wave radio supports beaming. It allows other devices in the network to wake up the Z-Wave thermostat, accept commands, and then go back to sleep.
- If you need the thermostat to operate in AOS mode (always listening mode) to act as signal repeater and to increase network reliability, you need to power the thermostat by 24 VAC. The AOS mode information is provided via Node Information Frame (NIF).

Wiring UWP

Push down on the tabs to put the wires into the inner holes of their corresponding terminals on the UWP (one wire per terminal) until they are firmly in place. **Gently tug on the wires to verify they are secure.** If you need to release the wires again, push down the terminal tabs on the sides of the UWP.

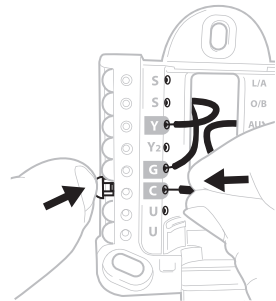

This wiring is just an example, yours may vary.

Setting Slider Tabs

Set R Slider Tab.

- Use built-in jumper (**R Slider Tab**) to differentiate between one or two transformer systems.
- If there is only one R wire, and it is connected to the **R**, **Rc**, or **RH** terminal, set the slider to the up position (**1 wire**).
- If there is one wire connected to the **R** terminal and one wire connected to the **Rc** terminal, set the slider to the down position (**2 wires**).

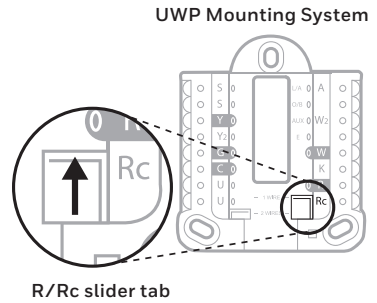

NOTE: Slider Tabs for U terminals should be left in place for other thermostat models.

Wiring terminal designations

S	Input for wired indoor or outdoor sensors	L/A - A	Heat Pump fault input (C wire required)
S		O/B	Changeover valve
Y	Compressor contactor (stage 1)	AUX - W2	Auxiliary heat relay Heat relay (stage 2)
Y2	Compressor contactor (stage 2)	E	Emergency Heat relay
G	Fan Relay	W	Heat relay (stage 1)
C	24 VAC common. For 2 transformer systems, use common wire from cooling transformer.	K	Connect to K on C-wire adapter**
U	Unused	R	24 VAC power from heating transformer*
U		Rc	24 VAC power from cooling transformer*

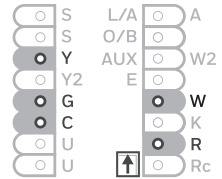

Note: Not all terminals may be used, depending on the system type that is being wired. The most commonly used terminals are shaded.

* Terminal can be jumped using Slider Tab. See “Setting Slider Tabs” above.

** The THP9045A1098 C-wire adapter is used on heat/cool systems when you only have four wires at the thermostat and you need a fifth wire for a common wire. Use the K terminal in place of the Y and G terminals on conventional or heat pump systems to provide control of the fan and the compressor through a single wire—the unused wire then becomes your common wire. See THP9045 instructions for more information.

Wiring conventional systems: forced air and hydronics

1H/1C System (1 transformer)

R	Power [1]
Rc	[R+Rc joined by Slider Tab] [2]
Y	Compressor contactor
C	24 VAC common [3]
W	Heat relay
G	Fan relay

Heat-only System

R	Power [1]
Rc	[R+Rc joined by Slider Tab] [2]
C	24 VAC common [3]
W	Heat relay

Heat-only System (Series 20) [5]

R	Series 20 valve terminal "R" [1]
Rc	[R+Rc joined by Slider Tab] [2]
Y	Series 20 valve terminal "W"
C	24 VAC common [3]
W	Series 20 valve terminal "B"

Heat-only System

(power open zone valve) [5]

R	Power [1]
Rc	[R+Rc joined by Slider Tab] [2]
W	Valve
C	24 VAC common [3]

1H/1C System (2 transformers)

R	Power (heating transformer) [1]
Rc	Power (cooling transformer) [1]
Y	Compressor contactor
C	24 VAC common [3, 4]
W	Heat relay
G	Fan relay

Heat-only System with Fan

R	Power [1]
Rc	[R+Rc joined by Slider Tab] [2]
C	24 VAC common [3]
W	Heat relay
G	Fan relay

Cool-only System

R	Power [1]
Rc	[R+Rc joined by Slider Tab] [2]
Y	Compressor contactor
C	24 VAC common [3]
G	Fan relay

2H/2C System (1 transformer) [6]

R	Power [1]
Rc	[R+Rc joined by Slider Tab] [2]
Y	Compressor contactor (stage 1)
C	24 VAC common [3]
W	Heat relay (stage 1)
G	Fan relay
W2	Heat relay (stage 2)
Y2	Compressor contactor (stage 2)

NOTES:

- Available wiring configurations may differ by product models/product numbers.
- Wire specifications: Use 18- to 22-gauge thermostat wire. Shielded cable is not required.

- [1] Power supply. Provide disconnect means and overload protection as required.
- [2] Move R-Slider Tab on UWP to the **R** setting. For more information, see "Setting Slider Tabs" on page 5.
- [3] Optional 24 VAC common connection.
- [4] If you do not have separate wires for the Aux and E terminals, connect the wire to the Aux terminal.

- [5] In Installer Setup Options (ISU), set system type to Boiler. Set number of cool stages to 0.
- [6] In Installer Setup Options (ISU), set system type to Conventional. Set cool stages to 2, and set heat stages to 2.

Wiring heat pump systems

1H/1C Heat Pump System

R Power [1]
Rc [R+Rc joined by Slider Tab] [2]
Y Compressor contactor
C 24 VAC common [3]
O/B Changeover valve [7]
G Fan relay

2H/1C Heat Pump System [8]

R Power [1]
Rc [R+Rc joined by Slider Tab] [2]
Y Compressor contactor
C 24 VAC common [3]
O/B Changeover valve [7]
G Fan relay
Aux Auxiliary heat [4]
E Emergency heat relay [4]
L Heat pump fault input

2H/2C Heat Pump System [6]

R Power [1]
Rc [R+Rc joined by Slider Tab] [2]
Y Compressor contactor (stage 1)
C 24 VAC common [3]
O/B Changeover valve [7]
G Fan relay
Y2 Compressor contactor (stage 2)
L Heat pump fault input

3H/2C Heat Pump System [10]

R Power [1]
Rc [R+Rc joined by Slider Tab] [2]
Y Compressor contactor (stage 1)
C 24 VAC common [3]
O/B Changeover valve [7]
G Fan relay
Aux Auxiliary heat [4]
E Emergency heat relay [4]
Y2 Compressor contactor (stage 2)
L Heat pump fault input

Dual Fuel System

R Power [1]
Rc [R+Rc joined by Slider Tab] [2]
Y Compressor contactor (stage 1)
C 24 VAC common [3]
O/B Changeover valve [7]
G Fan relay
Aux Auxiliary heat [4]
E Emergency heat relay [4]
Y2 Compressor contactor (stage 2 - if needed)
L Heat pump fault input
S Outdoor sensor
S Outdoor sensor

NOTES:

- Do **NOT** use **W** for heat pump applications. Auxiliary heat must wire to **AUX** or **E**.
- Available wiring configurations may differ by product models/product numbers.
- Wire specifications: Use 18- to 22-gauge thermostat wire. Shielded cable is not required.

- [1] Power supply. Provide disconnect means and overload protection as required.
- [2] Move R-Slider Tab on UWP to the **R** setting. For more information, see "Setting Slider Tabs" on page 5.
- [3] Optional 24 VAC common connection.
- [4] If you do not have separate wires for the Aux and E terminals, connect the wire to the Aux terminal.
- [6] In Installer Setup Options (ISU), set system type to Heat Pump. Set compressor stages to 2, and set Aux/E stages to 0.
- [7] In Installer Setup Options (ISU), set Reversing Valve to O/B on Cool (for cool changeover) or to O/B on Heat (for heat changeover).
- [8] In Installer Setup Options (ISU), set heat system type to Heat Pump. Set compressor stages to 1, and set Aux/E stages to 1.
- [10] In Installer Setup Options (ISU), set system type to Heat Pump, set compressor stages to 2, and set Aux/E stages to 1.

Mounting thermostat

- 1 Push excess wire back into the wall opening.
- 2 Close the UWP door. It should remain closed without bulging.
- 3 Align the UWP with the thermostat, and push gently until the thermostat snaps in place.
- 4 If needed, gently pull to remove the thermostat from the UWP.
- 5 Turn the power on at the breaker box or switch.

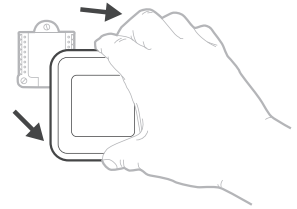
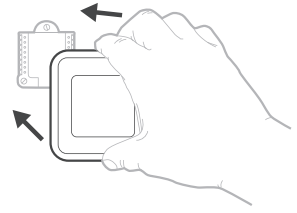

Initial installer setup

- After the T6 Pro Z-Wave thermostat has powered up, touch **START SETUP** on the thermostat.
- Touch or to toggle between Installer Set Up (ISU) options.
- Touch **Edit** or touch text area, and then touch or to edit default setup option.
- Touch **Done** or touch text area to confirm the setting or press **Cancel**.
- Touch or to continue to setup another ISU option.
- To finish setup and save your settings, scroll to the **Finish** screen at the end of the ISU list.

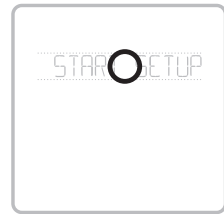

View ISU

ISU option and name (scrolling) Arrow buttons used to scroll through ISUs

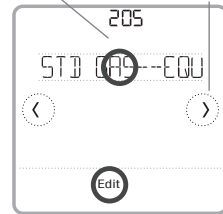

Edit ISU

ISU option blinking ISU # Arrow buttons used to scroll through ISU options

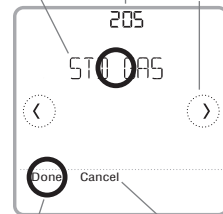

Saves selected ISU option moves on to the next ISU screen

Cancel ISU option selection, go back to view ISU

NOTES:

- To see a list of all setup parameters, go to "Installer setup options (ISU) – advanced menu" on page 15. The thermostat displays the ISU name and the ISU number.
- To prevent abnormal operation, it is highly recommended to perform installer setup and set thermostat to correct HVAC system before including it in a Z-Wave network.

Z-Wave setup

After you finish the installer setup and set the date and time, you will be asked to set up a Z-Wave to include the thermostat into Z-Wave network.

- Touch **Yes** to include the thermostat in to Z-Wave network, or touch **No** if you want this to be done later.
- You'll be asked to set your primary controller to **INCLUDE MODE**. Please refer to the user manual of your Z-Wave controller.
- After inclusion procedure has been initiated on your Z-Wave controller, touch **Select** on the thermostat.
- If the inclusion procedure is successful, **INCLUDED**, the node ID, and the Z-Wave connected status icon appear on the screen. If the procedure fails, **FAILED TO INCLUDE** appears on the screen. If this happens, position the thermostat closer to the Z-Wave controller and repeat the inclusion procedure.
- Your controller will indicate whether the thermostat was successfully added to its network. (Please refer to the user manual of your Z-Wave controller.)



NOTES:

- This thermostat will function as a normal programmable thermostat with the default program schedule if not included in a Z-Wave network. Once you include the thermostat in to Z-Wave network, it assumes to be programmed from your Z-Wave controller and the program schedule on the thermostat is turned OFF by default. For more information, see "Scheduling options" on page 12.
- To include or exclude the thermostat from Z-Wave network after initial thermostat setup, go to thermostat **MENU/Z-WAVE SETUP**.
- Before adding the thermostat to a Z-Wave network, check that it does not already belong to one. If the thermostat is included in Z-Wave network, it offers an option to exclude. If the thermostat is excluded from Z-Wave network, it offers an option to include. You can also check the status by viewing the **Node ID** located in the thermostat **MENU/DEVICE INFO**. An excluded thermostat should show zero for the Node ID (000).
- Whether you are including or excluding the thermostat from Z-Wave network, first you have to initiate it on your Z-Wave controller. Please refer to the user manual of your Z-wave controller.
- For other specific tasks such as adding the thermostat to home automation scenes or groups, refer to the user manual of your Z-Wave controller.

Advanced Z-Wave temperature reporting

This thermostat may be configured to report the actual room temperature in a higher resolution than can be shown on the thermostat display. The default temperature reporting resolution is 1 °F or 0.5 °C. When configured to **ADVANCED**, the temperature reporting resolution will be 0.5 °F or 0.25 °C. To change default temperature reporting to a higher resolution, go to thermostat **MENU/Z-WAVE SETUP/TEMP REPORT** and set to **ADVANCED**. The temperature is reported by every displayed value change, and no later than 2 hours from last report.

NOTE: When higher temperature resolution reporting set, you may experience different resolution of temperature displayed on the thermostat and Z-Wave controller.

Z-Wave connection status

Z-Wave connection status is located in the upper-right corner of the screen.

- Thermostat is included and connected to a Z-Wave network.
- Thermostat is excluded from a Z-Wave network.
- Thermostat is either included in a Z-Wave network but the Z-Wave signal is lost, or is included but AC power is lost (battery used as backup). In this case, Z-Wave radio is turned off to preserve battery life. AC power must be restored or you have to change the power mode. It can be done via excluding thermostat from Z-wave network and including again in battery power mode where batteries are used as main power source. You can check the actual power mode in the thermostat **MENU/DEVICE INFO**.

System operation setting

- 1 Press the **Mode** button to cycle to the next available System mode.
- 2 Cycle through the modes until the required System mode is displayed and leave it to activate.

System modes:

- **Heat:** Controls the heating system.
- **Cool:** Controls the cooling system.
- **Off:** Turns the heating and cooling systems off.
- **Auto:** When enabled, the thermostat will automatically use heating or cooling to reach the desired temperature.
- **Em Heat:** Controls auxiliary or emergency heat; only available on systems with a heat pump.

NOTES:

- Em Heat and Auto modes may not appear on the thermostat screen, depending on your equipment and how the thermostat was configured.
- Em Heat is only available if the thermostat is configured to control a heat pump and an auxiliary/emergency heat stage.
- When Auto mode is enabled and initiated, **Auto Chg. On** will appear in the upper-right corner of the thermostat home screen, and the active mode (Heat or Cool) will be displayed. Auto mode is disabled by default. To enable it, see "Installer setup – advanced menu" on page 14 and 16.

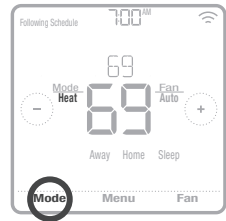

Fan operation setting

- 1 Press the **Fan** button to cycle to the next available Fan mode.
- 2 Cycle through the modes until the required Fan mode is displayed and leave it to activate.

NOTE: Available Fan modes vary with system settings.

Fan modes:

- **On:** The fan will run continuously.
- **Auto:** The fan will run only when the heating or cooling system is on.
- **Circ:** The fan will run at random intervals at least 35% of the time to keep air circulating throughout your home.



Scheduling options

This thermostat may be configured to be programmable or non programmable. Thermostat schedule is an optional menu item. It will only show up in the thermostat menu if enabled in the Installer setup – advanced menu. It provides setting for local thermostat schedule control.

Once the thermostat is included in to Z-Wave network, it assumes to be programmed from your Z-Wave controller and the program schedule on the thermostat is turned OFF by default. Use just the controller or associated app to program schedule (automation scenes) for the thermostat.

- Only Home and Away periods appear on the thermostat home screen.
- Home temperature setpoints are adjustable on the thermostat Home screen. Common for all days.
- Away mode is an Energy saving mode adjustable in the thermostat **MENU/ AWAY SETTING**. Common for all days.

See table below with default, adjustable settings:

Thermostat schedule is turned OFF , thermostat included in Z-Wave network			
Period	Start Time	Heat	Cool
Away	N/A*	62 °	85 °
Home	N/A*	72 °	78 °

*Triggered by Z-Wave controller

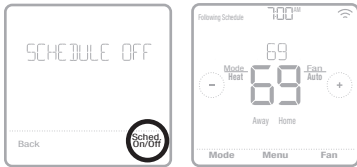

Enabling thermostat schedule when thermostat is included in Z-Wave network (optional):

Z-Wave controllers from various manufacturers may or may not support the Z-Wave Thermostat General V2 Device class used by the T6 pro Z-Wave Thermostat. If your controller does not support full thermostat device class functions, it may still be able to control basic Home/ Away (Energy Saving) modes of the thermostat through BASIC_SET commands (ON/OFF) used by the controller for other Z-Wave devices (eg. lighting devices). When only basic commands capable to receive from controller, you can enable the local thermostat schedule to differentiate between temperatures when you are away and when you are at home to differentiate between home and sleep temperatures.

- Home, Away and Sleep periods appear on the thermostat home screen.
- Home and Sleep temperature and time settings are adjustable in the thermostat **MENU/SCHEDULE**.
- Away mode is an Energy saving mode adjustable in the thermostat **MENU/ AWAY SETTING**. Common for all days.

See table below with default 5+2 schedule (Mon-Fri; Sat-Sun), adjustable settings:

Thermostat schedule is turned ON , thermostat included in Z-Wave network					
Period	Start Time	Heat (Mon-Fri)	Cool (Mon-Fri)	Heat (Sat-Sun)	Cool (Sat-Sun)
Away	N/A*	62 °	85 °	62 °	85 °
Home	6:00 AM	70 °	78 °	70 °	78 °
Sleep	10:00 PM	62 °	85 °	62 °	85 °

*Triggered by Z-Wave controller

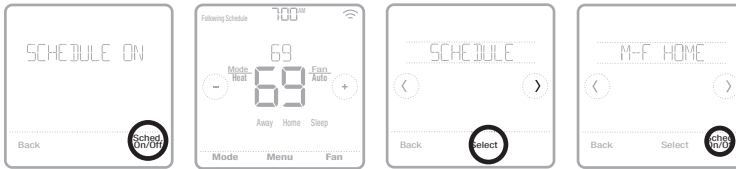

- If the Schedule menu on the thermostat does not appear, make sure that thermostat schedule is enabled. This setting is accessed from **INSTALLER SETUP – ADVANCED MENU** (see pages 14, 15), ISU 120 - Schedule type. Here you can also choose from pre-defined different thermostat program schedule types to be adjustable in the thermostat **MENU/SCHEDULE**.

Program schedule on the thermostat when not included in Z-Wave network (not operated by Z-Wave controller):

The T6 Pro Z-Wave thermostat will function as fully programmable thermostat when not operated by your controller. Each day can be programmed for different heating and cooling setpoints in 4 unique periods (Wake, Away, Home, Sleep) in the thermostat **MENU/SCHEDULE**. Make sure that thermostat schedule is enabled in **INSTALLER SETUP – ADVANCED** (see pages 14, 15), ISU 120 - Schedule type.

See table below with default 5+2 schedule (Mon-Fri; Sat-Sun), adjustable settings:

Thermostat schedule is turned ON , thermostat excluded from Z-Wave network					
Period	Start Time	Heat (Mon-Fri)	Cool (Mon-Fri)	Heat (Sat-Sun)	Cool (Sat-Sun)
Wake	6:00 AM	70 °	78 °	70 °	78 °
Away	8:00 AM	62 °	85 °	62 °	85 °
Home	6:00 PM	70 °	78 °	70 °	78 °
Sleep	10:00 PM	62 °	85 °	62 °	85 °

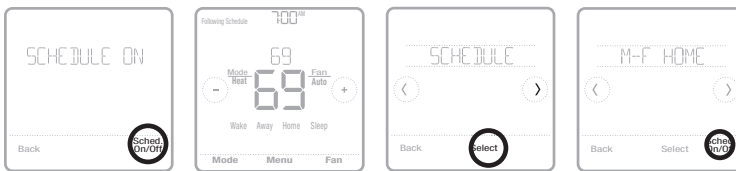

- Wake, Away, Home, Sleep periods appear on the thermostat home screen.
- Temperature setpoints for all four periods, different per day or group of days are adjustable in thermostat **MENU/ SCHEDULE**.

Key features

System status information

Cool On, Heat On, Auxiliary Heat On, Recovery, or Auto Changeover On.

Schedule information

Following time or occupancy based temperature control.

Desired temperature

Displays the desired temperature setting.

Indoor temperature/ % indoor relative humidity

Touch to display either indoor temperature or % indoor relative humidity.

Mode

Select system mode: Auto (if enabled)/Heat/Cool/Off/EM Heat (Emergency Heat if installed and configured).

Time, ISU #, or Alert

Z-Wave connection status

Shows Z-Wave connection status.

Messaging

Shows device setup options, menu options, reminders, schedule overrides.

Schedule period

Shows schedule period: Wake/Away/Home/Sleep. (varies on whether included in/excluded from Z-Wave network and program scheduled and enabled).

Fan

Select Fan mode Auto/On/Circulate.

Menu

Touch to display user options.

Note: Long press of Menu button for 5 seconds to access Advanced Menu options.

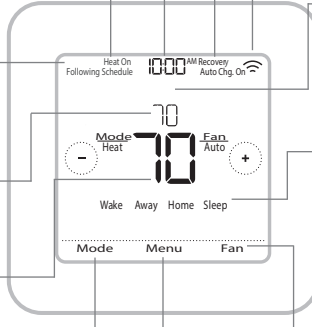



The screen will wake up by pressing the center area of the displayed temperature. If powered by 24 VAC, the screen stays lit for 45 seconds after you complete changes.

If powered by battery only, the screen stays lit for 8 seconds.

Brightness of an inactive backlight can be adjusted in the thermostat **MENU** only if the thermostat is powered by 24 VAC.

Installer setup – advanced menu

To access the advanced menu, press and hold the **Menu** button for **5 seconds**. Touch  or  to go through the options in the advanced menu.

Advanced menu options

Device Setup

This is used to access the device ISU setting.

Screen Lock

The thermostat touch screen can be locked fully or partially.

System Test

Test the heating and cooling system.

Reset

Access all reset options on the thermostat. This is the only place to access factory reset.

Range Stop (Temperature)

Set the Minimum Cool and Maximum Heat temperature set points.

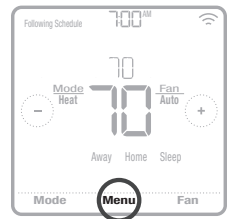

Press and hold for 5 seconds.

Installer setup options (ISU) – advanced menu

Table 1.

Note: ISU options available may vary upon the thermostat model and equipment setup.

# ISU	ISU Name	ISU Options (defaults in bold)	Notes
120	Schedule Type	No Schedule or Occupancy (when included in Z-Wave network) MO-SU = Every day the same MO-FR, SA, SU = 5-1-1 schedule MO-FR, SA-SU = 5-2 schedule Each Day = Every day/individual	You can change default MO-FR, SA-SU schedule here. To edit periods during days, temperature setpoints, or to turn Schedule On/Off , go to MENU/SCHEDULE (only available if schedule is set).
125	Temp Scale	Fahrenheit , Celsius	
130	Outdoor Temp	No , Wired	An outdoor temperature is required to set the following ISUs: ISU 355 Balance point (Compressor Lockout), ISU 356 Aux Heat Lockout. Use a wired outdoor sensor connected to the 'S' terminals on the UWP and set this ISU to Wired. ("Wiring heat pump systems" on page 7.)
200	System Type	Conventional Forced Air Heat Pump Boiler Cool Only	Basic selection of system your thermostat will control.
205	Equipment Type	<i>Conventional Forced Air Heat:</i> Standard Efficiency Gas (STD GAS), High Efficiency Gas (EFF GAS) , Oil, Electric, Hot Water Fan Coil <i>Heat Pump:</i> Air To Air , Geothermal <i>Boiler:</i> Hot Water Radiant Heat , Steam	This option selects the equipment type your thermostat will control. Note: This option is NOT displayed if ISU 200 is set to Cool Only.
218	Reversing Valve	O/B on Cool , O/B on Heat	This ISU is only displayed if ISU 200 is set to Heat Pump. Select whether reversing valve O/B should energize on cool or on heat.
220	Cool Stages (#200=Conv./200+HP)	0, 1, 2	
221	Heat Stages; Aux/E Stages (#200=Conv.; 200+HP)	Heat Stages: 0, 1, 2 AUX/E Stages: 0, 1	Maximum of 2 Heat Stages for conventional systems. Maximum of 1 Aux/E stages for heat pump systems.
230	Fan Control	Equipment, Thermostat	This ISU is only displayed if ISU 205 is set to Electric Forced Air or Fan Coil.
253	Aux/E Control	Both Aux/E , Either Aux/E	Set "EITHER AUX/E" if you want to setup and control of Auxiliary and Emergency heating separately. This ISU is only displayed if ISU 200 is set to Heat Pump AND if ISU 221 Aux/E stages = 1.
255	Aux Heat Type	Electric , Gas/Oil (or Fossil Forced Air)	This ISU is displayed only if ISU 200 is set to heat pump AND if ISU 221 Aux/E heat stages = 1.

Installer setup options (ISU) – advanced menu

Table 2.

# ISU	ISU Name	ISU Options (defaults in bold)	Notes
256	EM Heat Type	Electric , Gas/Oil (or Fossil/Forced Air)	This ISU is displayed only if ISU 200 is set to Heat Pump AND if ISU 221 Aux/E heat stages = 1 AND if ISU 253 is set to run Aux/E heat separately.
260	Fossil Kit Control	Thermostat , External (Fossil/Fuel Kit Controls Backup Heat)	This ISU is displayed only if ISU 200 is set to Heat Pump AND if ISU 221 Aux/E heat stages = 1 AND if ISU 256 is set to Gas/Oil.
300	Auto Changeover	On, Off	OFF: The user must select heating or cooling as needed to maintain the desired indoor temperature. ON (Automatic): On (enabled) Allows user to select Auto Changeover as one of the system modes from the home screen. In auto mode, the thermostat control either heating or cooling automatically to maintain the desired indoor temperature.
303	Auto Differential	0 °F to 5 °F or 0.0 °C to 2.5 °C	Differential is NOT deadband. Resideo uses an advanced algorithm that fixes deadband at 0 °F. The differential setting is the minimum number of degrees from set-point needed to switch from the last mode running (heat or cool) to the opposite mode when the thermostat is in auto-changeover. This is more advanced than previous thermostats.
305	High Cool Stage Finish	Yes, No	This ISU is only displayed when the thermostat is set to 2 cool stages. When set to YES, this feature keeps the higher stage of the cooling equipment running until the desired setpoint is reached.
306	High Heat Stage Finish	Yes, No	This ISU is only displayed when the thermostat is set to 2 or more heat stages. When set to YES, this feature keeps the higher stage of the heating equipment running until the desired setpoint is reached.
340	Aux Heat Droop	0 = Comfort ; 2 °F to 15 °F from setpoint (in 1 °F increments) or 1.0 °C to 7.5 °C from setpoint (in 0.5 °C increments)	Aux heat droop can be set on heat pump systems with an auxiliary heat stage. The Comfort setting is NOT available for Dual Fuel systems. Default setting is 0 °F (Comfort) for Electric while 2 °F for Gas/Oil. The indoor temperature must drop to the selected droop setting before the thermostat will turn Aux Heat on. For example, if Aux Heat is set to 2 °F (1.0 °C), the indoor temperature must be 2 °F (1.0 °C) away from the setpoint before Aux Heat turns on. When set to Comfort, the thermostat will use Aux Heat as needed to keep the indoor temperature within 1 °F (0.5 °C) degree of the setpoint.
350	Up Stage Timer Aux Heat	Off , 30, 45, 60, 75, 90 minutes 2, 3, 4, 5, 6, 8, 10, 12, 14, 16 hours	The Auxiliary Heat Upstage Timer starts when the highest stage of the previous heating equipment type turns on. Auxiliary heat will be used (if needed) when the timer expires. This ISU is only displayed when ISU 340 (Aux Heat Droop) is set to 2 °F or higher.
355	Balance Point (Compressor Lockout)	Off , 5 °F to 60 °F (in 5 °F increments) or 15.0 °C to 15.5 °C (in 2.5 °C or 3.0 °C increments)	Compressor Lockout requires an outdoor temperature. Set Compressor Lockout to the temperature below which it is inefficient to run the heat pump. When outside temperature is below this setting, thermostat will lockout the heat pump and run Aux Heat only. This ISU is only displayed if ISU 130 = Wired, ISU 200 is set to Heat Pump, ISU 221 Aux/E heat stages = 1. Default is 40 °F if ISU 205 Heating Equipment is Air to Air Heat Pump and ISU 255 Aux Heat Type is Gas/Oil. Default is Off if ISU 205 Heating Equipment is Air to Air Heat Pump and ISU 255 Aux Heat Type is Electric. Default is Off if ISU 205 Heating Equipment is Geothermal. Compressor Lockout is optional for any type of heat pump (Air to Air Heat Pump, Geothermal Heat Pump).
356	Aux Heat Lock Out (Aux Heat Outdoor Lockout)	Off , 5 °F to 65 °F (in 5 °F increments) or -15.0 °C to 18.5 °C (in 2.5 °C or 3.0 °C increments)	Aux Heat Lockout requires an outdoor temperature. Set Aux Heat Lockout to optimize energy bills and to not allow to run the more expensive Aux Heat source above certain outdoor temperature limit. This ISU is only displayed if ISU 130 = Wired, ISU 200 is set to Heat Pump, ISU 221 Aux/E heat stages = 1.

Installer setup options (ISU) – advanced menu

Table 3.

# ISU	ISU Name	ISU Options (defaults in bold)	Notes
365	Cool 1 CPH (Cooling cycle rate stage 1)	1 - 6 CPH (3 CPH)	This ISU is only displayed when Cool / Compressor Stages is set to 1 or more stages. Cycle rate limits the maximum number of times the system can cycle in a 1 hour period measured at a 50% load. For example, when set to 3 CPH, at a 50% load, the most the system will cycle 3 times per hour (10 minutes on, 10 minutes off). The system cycles less often when load conditions are less than or greater than a 50% load.
366	Cool 2 CPH (Cooling cycle rate stage 2)	1 - 6 CPH (3 CPH)	This ISU is only displayed when Cool / Compressor Stages is set to 2.
370	Heat 1 CPH (Heating cycle rate stage 1)	1 - 12 CPH	This ISU is only displayed when Heat Stages is set to 1 stage or more stages. Cycle rate limits the maximum number of times the system can cycle in a 1 hour period measured at a 50% load. For example, when set to 3 CPH, at a 50% load, the most the system will cycle 3 times per hour (10 minutes on, 10 minutes off). The system cycles less often when load conditions are less than or greater than a 50% load. The recommended (default) cycle rate settings are below for each heating equipment type: Standard Efficiency Gas Forced Air = 5 CPH; High Efficiency Gas Forced Air = 3 CPH; Oil Forced Air = 5 CPH; Electric Forced Air = 9 CPH; Fan Coil = 3 CPH; Hot Water Radiant Heat = 3 CPH; Steam = 1 CPH.
371	Heat 2 CPH (Heating cycle rate stage 2)	1 - 12 CPH	This ISU is only displayed when Heat Stages is set to 2 stages. The recommended (default) cycle rate settings are below for each heating equipment type: Standard Efficiency Gas Forced Air = 5 CPH; High Efficiency Gas Forced Air = 3 CPH; Oil Forced Air = 5 CPH; Electric Forced Air = 9 CPH; Fan Coil = 3 CPH; Hot Water Radiant Heat = 3 CPH; Steam = 1 CPH.
375	Aux Heat CPH (Heating cycle rate Auxiliary Heat)	1 - 12 CPH	This ISU is only displayed when ISU 200 = Heat Pump and ISU 221=1. It is only displayed when Auxiliary Heat is configured. The recommended cycle rate settings are below for each heating equipment type: Standard Efficiency Gas Forced Air = 5 CPH; High Efficiency Gas Forced Air = 3 CPH; Oil Forced Air = 5 CPH; Electric Forced Air = 9 CPH
378	EM Heat CPH (Heating cycle rate Emergency Heat)	1 - 12 CPH	This ISU is only displayed when Emergency Heat is configured and ISU 253-Aux/E Terminal Control is set to control Aux and E heat independently. The recommended cycle rate settings are below for each heating equipment type: Standard Efficiency Gas Forced Air = 5 CPH; High Efficiency Gas Forced Air = 3 CPH; Oil Forced Air = 5 CPH; Electric Forced Air = 9 CPH.
387	Compressor Protection	Off , 1 - 5 minutes	The thermostat has a built in compressor protection (minimum off timer) that prevents the compressor from restarting too early after a shutdown. The minimum-off timer is activated after the compressor turns off. If there is a call during the minimum-off timer, the thermostat shows "Cool on" or "Heat On" (heat pump) status blinking on the thermostat home screen. This ISU is displayed if ISU 220 is set to at least 1 stage.
390	Ext Fan Run Time in Cool	Off , 30, 60, 90 seconds 2, 3, 4, 5, 6, 7, 8, 9, 10, 11, 12, 13, 14, 15 minutes	After the call for cooling ends, the thermostat keeps the fan on for the selected amount of time for increased efficiency. This may reintroduce humidity into the living space. This ISU is displayed if ISU 220 is set to at least 1 stage.
391	Ext Fan Run Time in Heat	Off , 30, 60, 90 seconds 2, 3, 4, 5, 6, 7, 8, 9, 10, 11, 12, 13, 14, 15 minutes	After the call for heating ends, the thermostat keeps the fan on for the selected amount of time for increased efficiency. This ISU is displayed if ISU 230 is set to Thermostat Controls Fan.

Installer setup options (ISU) – advanced menu

Table 4.

# ISU	ISU Name	ISU Options (defaults in bold)	Notes
425	Adaptive Recovery	On, Off	Adaptive Intelligent Recovery (AIR) is a comfort setting. Heating or cooling equipment will turn on earlier, ensuring the indoor temperature will match the setpoint at the scheduled time.
430	Minimum Cool Setpoint	50 °F to 99 °F (50 °F); 10.0 °C to 37.0 °C (10.0 °C)	The user cannot set the cooling temperature below this level.
431	Maximum Heat Setpoint	40 °F to 90 °F (90 °F); 4.5 °C to 32.0 °C (32.2 °C)	The user cannot set the heating temperature above this level.
435	Lock Screen	None , Partial, Full	Unlocked: User has access to all thermostat settings. Partially Locked: User can modify only temperature settings. Fully Locked: User cannot modify any settings. Screen will be locked by default factory code and cannot be changed. This code is displayed for a short time, when you are about to lock the thermostat screen. Please note the code in safe place for future reference.
500	Indoor Sensor	Yes, No	Set this ISU when you want to wire a remote indoor sensor to the "S" terminals on the UWP - see "Wiring terminal designations" on page 5. This ISU is only displayed only if ISU 1.30 is set to NO wired outdoor sensor configured.
515	Sensor type	10k , 20k	Choose resistance type of wired indoor sensor. This ISU is only displayed when indoor sensor is configured - ISU 500.
520	Temperature Control	Thermostat, Wired, Average	This ISU is only displayed when indoor sensor is configured - ISU 500. You can choose what temperature source to be used or you can ask thermostat to use both thermostat and remote sensors for higher accuracy of measurement.
702	Air Filters	0 - 2	This ISU refers to the number of air filters in the system.
711	Air Filter 1 Reminder	Off 10, 20, 30, 45, 60, 90, 120, 150 Run Time Days 30, 45, 60, 75 Days 3, 4, 5, 6, 9, 12, 15 Months	Choose either calendar or equipment run time-based reminder.
712	Air Filter 2 Reminder	Off 10, 20, 30, 45, 60, 90, 120, 150 Run Time Days 30, 45, 60, 75 Days 3, 4, 5, 6, 9, 12, 15 Months	Choose either calendar or equipment run time-based reminder.
810	Hum Pad Reminder	Off 6, 12 Calendar Months	
921	Dehum Filter Reminder	Off 30, 60 Calendar Days 3 - 12 Calendar Months (in 1 month increments)	
1018	Vent Filter Reminder	Off , 3, 6, 9, 12 months	

Installer setup options (ISU) – advanced menu

Table 5.









# ISU	ISU Name	ISU Options (defaults in bold)	Notes
1100	UV Devices	0 - 2	Some systems may have two UV devices, one for the A-Coil and another for Air Treatment. A replacement reminder can be setup for each one separately.
1105	UV Bulb 1 Reminder	Off , 6, 12, 24 months	
1106	UV Bulb 2 Reminder	Off , 6, 12, 24 months	
1401	Idle Brightness	0- Off , 0 - 5	Adjust brightness of an inactive backlight (idle screen) from default 0 (backlight off) to 5 (maximum brightness). Brightness level higher than 0 will be applied and enabled for user to change in user menu only if thermostat is powered by 24 VAC (C-wire)
1410	Clock Format	12 hour , 24 hour	
1415	Daylight Saving	On , Off	Set to Off in areas that do not follow Daylight Saving Time.
1420	Temperature Offset	0-Off , -3 °F to 3 °F (in 1 °F increments) or -1.5 °C to 1.5 °C (in 0.5 °C increments)	0 °F - No difference in displayed temperature and the actual room temperature. The thermostat can display up to 3 °F (1.5 C) lower or higher than the actual measured temperature.
1425	Humidity Display Offset	0-Off , -12% to 12% (in 1% increments)	0% - No difference in displayed and actual room % relative humidity. The thermostat can display up to 12% lower or higher than the actual measured % relative humidity.

Z-Wave configuration parameters

If your gateway/hub/controller supports configuration function, you may remotely configure or change the default thermostat configuration parameters. For detailed table with all available Z-Wave configuration parameters go to <http://customer.resideo.com> or search for **T6 Pro Z-Wave Thermostat** in the Z-Wave certified products section on <http://Z-Wavealliance.org>

Performing a system test

You can test the system setup in **ADVANCED MENU** under **SYSTEM TEST** option.



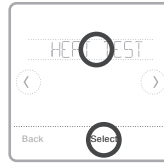
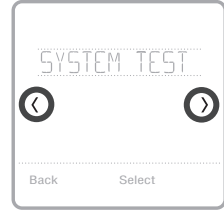

- 1 Press and hold **Menu** on the thermostat for 5 seconds to access **ADVANCED MENU** options.
- 2 Touch  or  to go to **SYSTEM TEST**.
- 3 Touch **Select** or touch text area.
- 4 Touch  or  to select system test type. Touch **Select** or touch text area.
- 5 For the heat test and cool test, use  or  to activate each stage of the equipment. For the fan test, use  or  to turn the fan on and off.

NOTE: The clock is used as a timer while the stages are running. The Heat On and Cool On indicators are displayed when the system test is running.



Viewing equipment status

You can see the status of thermostat-controlled equipment in the **Menu** under the **EQMT STATUS** option.

- 1 Touch **Menu** on your thermostat.
- 2 Touch  or  to go to **EQMT STATUS**. Touch **Select** or touch text area.
- 3 Touch  or  to view statuses of all the equipment the thermostat is controlling. Depending on what feature the thermostat supports or how it was installed, the Equipment Status screen reports data for the following systems:
 - Heating and cooling
 - Fan

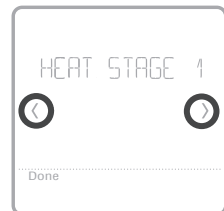
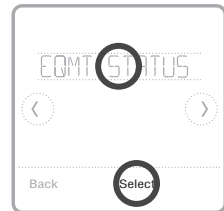

Alerts and reminders

Alerts and reminders are displayed via the alert symbol and alert number in the clock area on the home screen. You can read more information about active alerts, snooze or dismiss non-critical alerts in Menu/Alerts.

Number	Alert/Reminder	Definition
54	Thermostat Humidity Sensor Error	The sensor of the thermostat has encountered an error. Please contact dealer to replace the thermostat.
164	Heat Pump Needs Service	Heat pump needs service. Contact dealer to diagnose and service heat pump.
170	Internal Memory Error	The memory of the thermostat has encountered an error. Please contact dealer for assistance.
171	Set the Date and Time	Set the date and time on your thermostat. The date and time are required for certain features to operate, like the program schedule.
173	Thermostat Temperature Sensor Error	The sensor of the thermostat has encountered an error. Please contact dealer to replace the thermostat.
177	Indoor Temperature Sensor Error	Wired indoor temperature sensor is not connected or there is a wiring short. Please contact dealer for assistance.
178	Outdoor Temperature Sensor Error	Wired outdoor temperature sensor is not connected or there is a wiring short. Please contact dealer for assistance.
181	Replace Air Filter (1)	Replace air filter (1). Reset the timer by touching the "dismiss" button on thermostat screen after it is replaced.
182	Replace Air Filter (2)	Replace air filter (2). Reset the timer by touching the "dismiss" button on thermostat screen after it is replaced.
184	Replace Humidifier Pad	Replace humidifier pad. Reset the timer by touching the "dismiss" button on the thermostat screen after it is replaced.
185	Replace Dehumidifier Filter	Replace the dehumidifier filter. Reset the timer by touching "dismiss" button on thermostat screen after it is replaced.
187	Clean or Replace Ventilator Filter	Clean or replace ventilator filter. Reset the timer by touching the "dismiss" button on thermostat screen after it is replaced.
188	Replace UV Bulb (1)	Replace UV Bulb (1). Reset the timer by touching the "dismiss" button on thermostat screen after it is replaced.
189	Replace UV Bulb (2)	Replace UV Bulb (2). Reset the timer by touching the "dismiss" button on thermostat screen after it is replaced.

Alerts and reminders

Number	Alert/Reminder	Definition
252	AC Power Lost	If batteries used as backup power it would drain batteries quickly so Z-Wave communication needs to be turned off. The working power mode can only be changed when thermostat is NOT included in a Z-Wave network. Either to exclude and include thermostat back in to Z-Wave network to change the power mode to LSS (power-save, sleep mode) or to resume AC power. You can check the actual power mode in the thermostat MENU/DEVICE INFO .
405	Battery Low	Battery low. Please turn the system mode to off and replace the batteries.
407	Battery Critical	Battery critical. Thermostat cannot control your system. Please replace the batteries immediately.
546	Z-Wave Not Configured	Z-Wave has a not been configured yet to receive commands from your Z-Wave network. Please follow steps on how to include thermostat in to Z-Wave network.
547	Z-Wave Radio Error	Z-Wave module is not operating. Thermostat cannot receive commands from your Z-Wave network. Please contact dealer to replace the thermostat.

Troubleshooting

Screen is blank

- Check circuit breaker and reset if necessary.
- Make sure power switch at heating and cooling system is on.
- Make sure furnace door is closed securely.
- If battery powered, make sure the batteries are correctly inserted and are not dead.

Screen is difficult to read

- Change screen brightness in thermostat **Menu**. Increase brightness intensity for inactive backlight of the thermostat screen (max. is level 5). Setting is available only if thermostat is AC powered.

Heating or cooling system does not respond

- Touch **Mode** to set system to Heat. Make sure the temperature is set higher than the Inside temperature.
- Touch **Mode** to set system to Cool. Make sure the temperature is set lower than the Inside temperature.
- Check circuit breaker and reset if necessary.
- Make sure power switch at heating & cooling system is on.
- Make sure furnace door is closed securely.

Heat runs with cooling

- Verify there is not a wire attached to W for heat pump systems. See wiring on pages 6-7.

Specifications

Model Number: TH6320ZW2003

Model Name: T6 Pro Z-Wave Thermostat

Model Description: Programmable Z-Wave thermostat with touchscreen

Stages:

Up to 3 Heat / 2 Cool Heat Pump

Up to 2 Heat / 2 Cool Conventional

Power Requirements

Battery power: AA alkaline battery 3pcs.

C-wire input: 18-30VAC; 50Hz-60Hz

Electrical Ratings:

Terminal	Voltage (50/60Hz)	Running Current
W Heating (Powerpile)	18-30 Vac 750 mV DC	0.02-1.0 A 100 mA DC
W2 (Aux) Heating	18-30 Vac	0.02-1.0 A
E Emergency Heat	18-30 Vac	0.02-0.5 A
Y Compressor Stage 1	18-30 Vac	0.02-1.0 A
Y2 Compressor Stage 2	18-30 Vac	0.02-1.0 A
G Fan	18-30 Vac	0.02-0.5 A
O/B Changeover	18-30 Vac	0.02-0.5 A
L/A Input	18-30 Vac	0.02-0.5 A

Dimension: 4.09" x 4.09" x 1.06"

Display Size: 6.55 sq. in.

Temperature Ranges

Adjustable Heat Temperature Range Setting:
40-90 °F (4.5-32.0 °C)

Adjustable Cool Temperature Range Setting:
50-99 °F (10.0-37.0 °C)

Operating Ambient Temperature Range

Thermostat: 37-102°F (2.78-38.89 °C)

Operating Relative Humidity Range

Thermostat: 5% to 90% (non-condensing)

Temperature Sensor Accuracy

Thermostat: ± 1.5 °F at 70 °F (0.85 °C at 21.0 °C)

Physical Dimensions in Inches (mm) (H x W x D)

T6 PRO Z-Wave Thermostat (TH6320ZW2003):

4-5/64 x 4-5/64 x 1-1/16 (104 x 104 x 27)

UWP Mounting System (included):

2-9/32 x 2-13/64 x 2-43/64 (58 x 56 x 10)

Standard Installation Adapter (included):

3-29/32 x 3-57/64 x 21/32 (99 x 99 x 17)

Decorative Cover Plate – Small (included):

4-49/64 x 4-49/64 x 11/32 (121 x 121 x 9)

Decorative Cover Plate – Large (THP2400A1068):

6-7/64 x 6-7/64 x 9/32 (155 x 155 x 7)

Z-Wave Radio:

Frequency (USA and Canada): 908.42 MHz

Certified: Z-Wave Plus

Generic Device Type: Thermostat

Node type (C-wire): Always On Slave (AOS)

Node type (Battery): Listening Sleeping Slave (LSS)

Z-Wave Chipset: ZM5202AU

Supported Z-Wave Command Classes:

Z-Wave Plus Info V2

Supervision V1

Transport Service V2

Association V2

Version V2

Association Group Information V2

Basic V1

Battery V1

Clock V1

Configuration V4

Device Reset Local V1

Manufacturer Specific V2

Sensor Multilevel V5

Notification V3

Powerlevel V1

Security 2 V1

Thermostat Fan Mode V3

Thermostat Fan State V1

Thermostat Mode V3

Thermostat Operating State V1

Thermostat Setpoint V2

NOTES:

Thermostat Mode V3:

- Some of the reported modes are manufacturer specific if not covered by the Z-Wave command class.

Basic V1 (basic set command implementation):

- Value 0x00 Device goes to Energy saving setting (AWAY mode)
- Values 0x01-0x63 and 0xFF Device goes to Comfort setting (HOME mode)

Notification V3:

- Notification V3 is enabled by default (Power management alarm handling). Notification Type: Power Management (0x08). Notification Events: AC mains disconnected (0x02), AC mains re-connected (0x03).

Security:

- All supported Z-Wave Command classes are supported securely (S2 unauthenticated), except Transport Service V2, Security 2 V1 and Z-Wave Plus Info V2

Association V2:

- Group ID: 1; Maximum Nodes: 1; Description: Z-Wave Plus Lifeline
- Command Classes reported: Multilevel Sensor, Thermostat Setpoint, Thermostat Mode
- Thermostat Fan Mode, Thermostat Operating State, Thermostat Fan State, Basic

**CAUTION: ELECTRICAL HAZARD**

Can cause electrical shock or equipment damage. Disconnect power before beginning installation.

**CAUTION: EQUIPMENT DAMAGE HAZARD**

Compressor protection is bypassed during testing. To prevent equipment damage, avoid cycling the compressor quickly.

**CAUTION: MERCURY NOTICE**

This product should not be disposed of with other household waste. If this product is replacing a control that contains mercury in a sealed tube, do not place the old control in the trash. Check for the nearest authorized collection centers or authorized recyclers.

5-year limited warranty

For Warranty information go to <http://customer.resideo.com>

Regulatory information

FCC REGULATIONS**§ 15.19 (a)(3)**

This device complies with part 15 of the FCC Rules.

Operation is subject to the following two conditions:

- 1 This device may not cause harmful interference, and
- 2 This device must accept any interference received, including interference that may cause undesired operation.

IC REGULATIONS**RSS-GEN**

This device contains licence-exempt transmitter(s)/

receiver(s) that comply with Innovation, Science and Economic Development Canada's licence-exempt RSS(s).

Operation is subject to the following two conditions:

- 1 This device may not cause interference.
- 2 This device must accept any interference, including interference that may cause undesired operation of the device.

FCC Warning (Part 15.21) (USA only)

Changes or modifications not expressly approved by the party responsible for compliance could void the user's authority to operate the equipment.

FCC - 47 CFR § 15.105 (b)

See <https://customer.resideo.com/en-US/support/residential/codes-and-standards/FCC15105/Pages/default.aspx> for additional FCC information for this product.

The operation of this equipment is subject to the following two conditions: (1) this equipment or device may not cause harmful interference, and (2) this equipment or device must accept any interference, including interference that may cause undesired operation.

**resideo**

Resideo Inc., 1985 Douglas Drive North
Golden Valley, MN 55422

www.resideo.com

33-00294-07 M.S. Rev. 04-19 | Printed in United States