



SPLIT-TYPE AIR CONDITIONERS

Revision A:

- 3. SPECIFICATION and 7-2. PERFORMANCE CURVE has been modified.

Please void OBH753.

OUTDOOR UNIT SERVICE MANUAL



**No. OBH753
REVISED EDITION-A**

Models

- MUFZ-KJ09NAHZ** - U1
- MUFZ-KJ12NAHZ** - U1
- MUFZ-KJ15NAHZ** - U1
- MUFZ-KJ18NAHZ** - U1

**Indoor unit service manual
MFZ-KJ•NA Series (OBH752)**

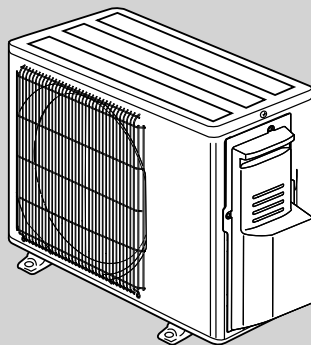

**MUFZ-KJ09NAHZ
MUFZ-KJ12NAHZ**

CONTENTS

1. TECHNICAL CHANGES	2
2. PART NAMES AND FUNCTIONS	3
3. SPECIFICATION	4
4. OUTLINES AND DIMENSIONS	6
5. WIRING DIAGRAM	8
6. REFRIGERANT SYSTEM DIAGRAM	10
7. DATA	12
8. ACTUATOR CONTROL	20
9. SERVICE FUNCTIONS	21
10. TROUBLESHOOTING	22
11. DISASSEMBLY INSTRUCTIONS	43

PARTS CATALOG (OBB753)

NOTE:

RoHS compliant products have <G> mark on the spec name plate.

Use the specified refrigerant only

Never use any refrigerant other than that specified.

Doing so may cause a burst, an explosion, or fire when the unit is being used, serviced, or disposed of.

Correct refrigerant is specified in the manuals and on the spec labels provided with our products.

We will not be held responsible for mechanical failure, system malfunction, unit breakdown or accidents caused by failure to follow the instructions.

Revision A:

- 3. SPECIFICATION and 7-2. PERFORMANCE CURVE has been modified.

1

TECHNICAL CHANGES

MUFZ-KJ09NAHZ

MUFZ-KJ12NAHZ

MUFZ-KJ15NAHZ

MUFZ-KJ18NAHZ

1. New model

2

PART NAMES AND FUNCTIONS

MUFZ-KJ09NAHZ
MUFZ-KJ12NAHZ

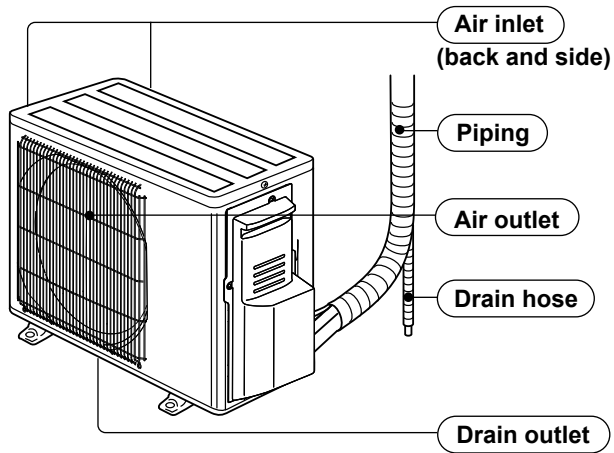

MUFZ-KJ15NAHZ
MUFZ-KJ18NAHZ

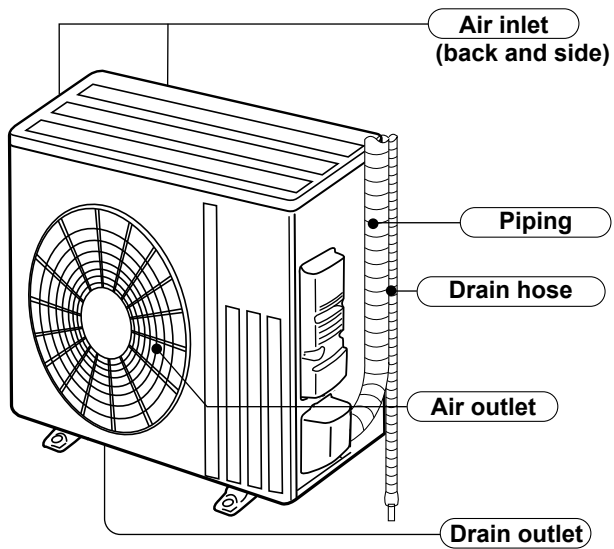

3

SPECIFICATION

Outdoor unit model			MUFZ-KJ09NAHZ	MUFZ-KJ12NAHZ	MUFZ-KJ15NAHZ	MUFZ-KJ18NAHZ
Capacity Rated (Minimum~Maximum)	Cooling *1	Btu/h	9,000 (2,300 - 14,000)	12,000 (2,300 - 15,000)	15,000 (5,300 - 19,000)	17,000 (5,300 - 22,500)
	Heating 47 *1	Btu/h	11,000 (2,900 - 19,000)	13,000 (2,900 - 22,800)	18,000 (5,700 - 25,000)	21,000 (5,700 - 29,000)
Capacity Rated (Maximum)	Heating 17 *2	Btu/h	7,500 (13,400)	8,800(14,800)	12,000 (20,500)	12,800 (23,000)
Power consumption Rated (Minimum~Maximum)	Cooling *1	W	570 (180 - 1,250)	890 (180 - 1,380)	1,120 (420 - 1,850)	1,350 (420 - 2,320)
	Heating 47 *1	W	750 (270 - 2,370)	900 (270 - 2,390)	1,410 (480 - 3,410)	1,730 (480 - 3,430)
Power consumption Rated (Maximum)	Heating 17 *2	W	810 (1,860)	930 (1,890)	1,300 (3,190)	1,430 (3,210)
EER *1 [SEER] *3	Cooling		15.8 [28.2]	13.6 [25.5]	13.5 [21.8]	12.6 [21.0]
HSPF IV *4	Heating		13.0	12.0	11.6	11.3
COP	Heating *1		4.3	4.2	3.7	3.5
Power supply	V , phase , Hz		208/230, 1 , 60			
Max. fuse size (time delay)	A		15		20	
Min. circuit ampacity	A		11		16	
Fan motor	F.L.A		0.50		0.93	
Compressor	Model		SNB140FQUMT		SNB172FQKMT	
	R.L.A		8.2		12.0	
	L.R.A		10.3		15.0	
	Refrigeration oil	fl oz. (L) (Model)	11.8 (0.35)/(FV50S)		13.5 (0.40)/(FV50S)	
Refrigerant control			Linear expansion valve			
Sound level *1	Cooling	dB(A)	48	48	51	51
	Heating	dB(A)	50	50	55	55
Defrost method			Reverse cycle			
Dimensions	W	in.	31-1/2		33-1/16	
	D	in.	11-1/4		13	
	H	in.	21-5/8		34-5/8	
Weight	lb.		83		124	
External finish			Munsell 3Y 7.8/1.1			
Remote controller			Wireless type			
Control voltage (by built-in transformer)		VDC	12 - 24			
Refrigerant piping			Not supplied			
Refrigerant pipe size (Min. wall thickness)	Liquid	in.	1/4 (0.0315)			
	Gas	in.	3/8 (0.0315)		1/2 (0.0315)	
Connection method	Indoor		Flared			
	Outdoor		Flared			
Between the indoor & outdoor units	Height difference	ft.	40		50	
	Piping length	ft.	65		100	
Refrigerant charge (R410A)			2 lb. 10 oz.		3 lb. 5 oz.	

NOTE: Test conditions are based on AHRI 210/240.

- *1: Rating conditions (Cooling) — Indoor: 80°FDB, 67°FWB, Outdoor: 95°FDB, (75°FWB)
(Heating) — Indoor: 70°FDB, 60°FWB, Outdoor: 47°FDB, 43°FWB
- *2: (Heating) — Indoor: 70°FDB, 60°FWB, Outdoor: 17°FDB, 15°FWB

Test condition

*3,*4

ARI	Mode	Test	Indoor air condition (°F)		Outdoor air condition (°F)	
			Dry bulb	Wet bulb	Dry bulb	Wet bulb
	SEER (Cooling)	"A-2" Cooling Steady State at rated compressor Speed	80	67	95	(75)
		"B-2" Cooling Steady State at rated compressor Speed	80	67	82	(65)
		"B-1" Cooling Steady State at minimum compressor Speed	80	67	82	(65)
		"F-1" Cooling Steady State at minimum compressor Speed	80	67	67	(53.5)
		"E-V" Cooling Steady State at Intermediate compressor Speed *5	80	67	87	(69)
	HSPF (Heating)	"H1-2" Heating Steady State at rated compressor Speed	70	60	47	43
		"H3-2" Heating at rated compressor Speed	70	60	17	15
		"H0-1" Heating Steady State at minimum compressor Speed	70	60	62	56.5
		"H1-1" Heating Steady State at minimum compressor Speed	70	60	47	43
		"H2-V" Heating at Intermediate compressor Speed *5	70	60	35	33

*5: At Intermediate compressor Speed
 = ("Rated compressor speed" - "minimum compressor speed") / 3 + "minimum compressor speed".

OPERATING RANGE

(1) POWER SUPPLY

	Rated voltage	Guaranteed voltage (V)
Outdoor unit	208/230 V 1 phase 60 Hz	<p>Min. 187 208 230 Max. 253</p>

(2) OPERATION

Mode	Condition	Intake air temperature (°F)			
		Indoor		Outdoor	
		DB	WB	DB	WB
Cooling	Standard temperature	80	67	95	—
	Maximum temperature	90	73	115	—
	Minimum temperature	67	57	14	—
	Maximum humidity	78 %		—	
Heating	Standard temperature	70	60	47	43
	Maximum temperature	80	67	75	65
	Minimum temperature	70	60	-13	-14

MUFZ-KJ09NAHZ MUFZ-KJ12NAHZ

Unit: inch

REQUIRED SPACE

*1 4 in. (100 mm) or more when front and sides of the unit are clear

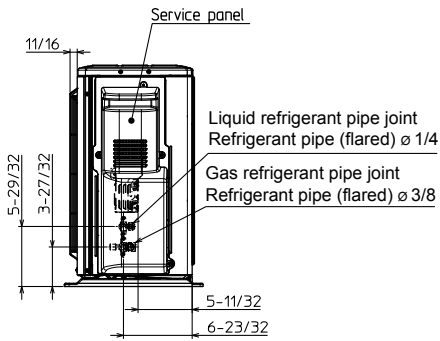
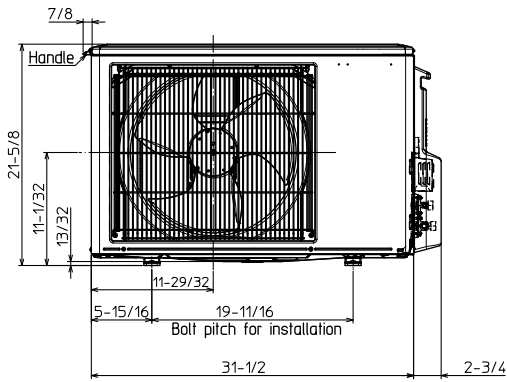
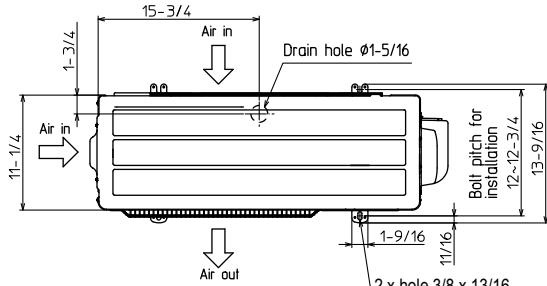
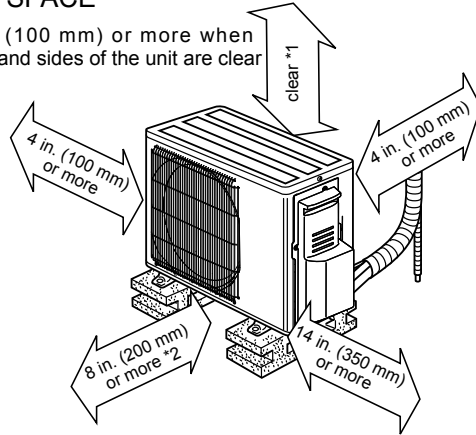

MUFZ-KJ15NAHZ MUFZ-KJ18NAHZ

Unit: inch

REQUIRED SPACE

*1 20 in. (500 mm) or more when front and sides of the unit are clear

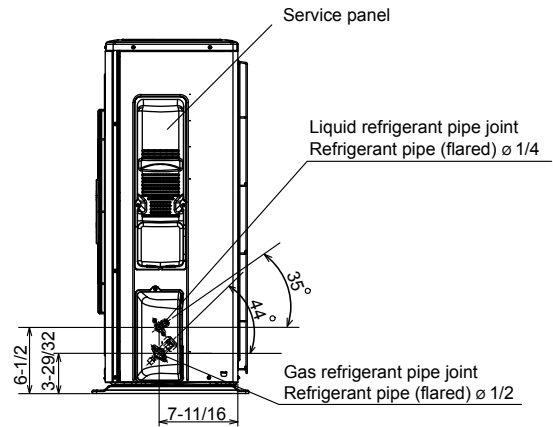
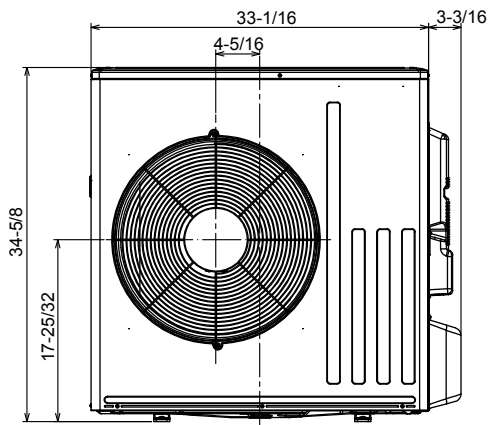
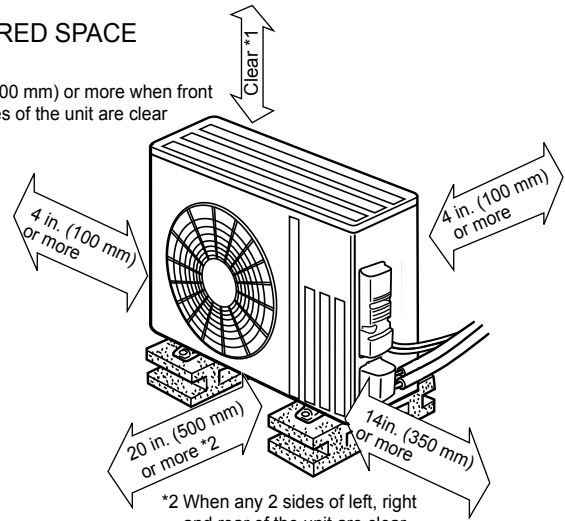
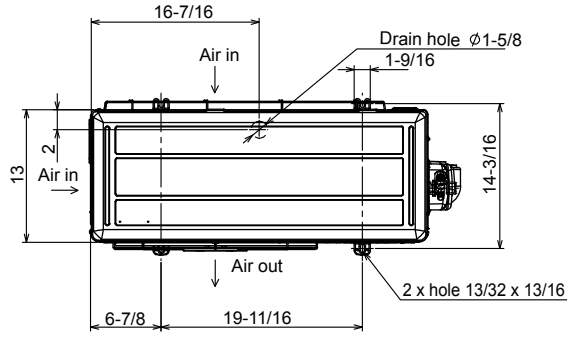

MUFZ-KJ09NAHZ MUFZ-KJ12NAHZ

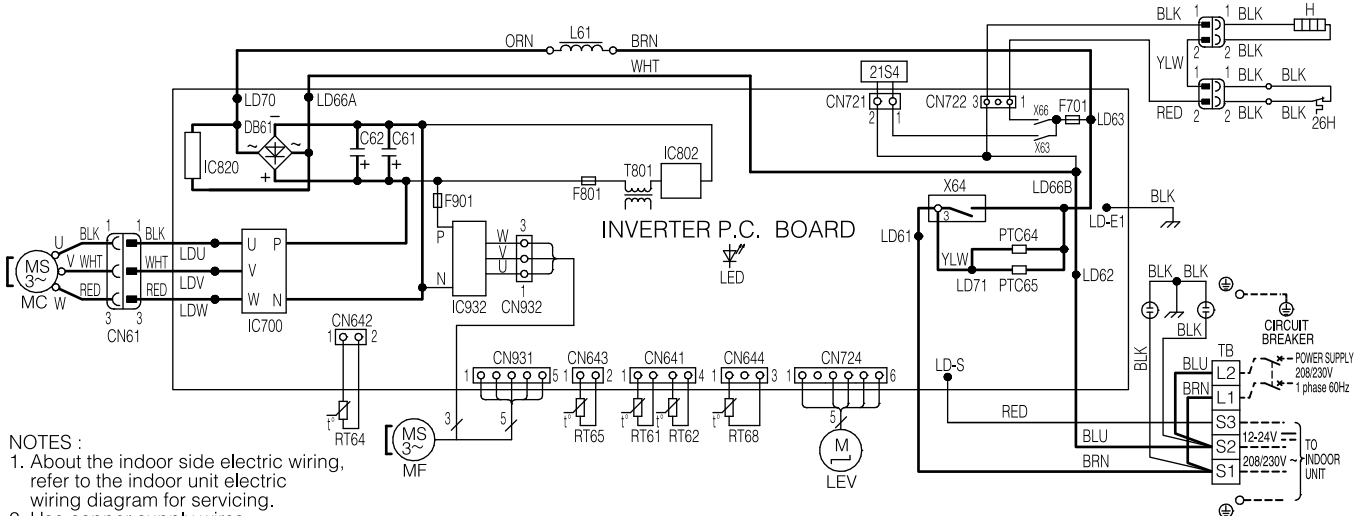

NOTES :

1. About the indoor side electric wiring, refer to the indoor unit electric wiring diagram for servicing.
2. Use copper supply wires.
3. Symbols indicate, :Terminal block
 :Connector

REMARQUES :

1. Pour le câblage électronique côté intérieur, se reporter au schéma d'entretien du câblage électronique de l'appareil intérieur.
2. Utiliser des fils d'alimentation en cuivre.
3. Les symboles ont les significations suivantes, :Borne
 :Connecteur

SYMBOL	NAME	SYMBOL	NAME	SYMBOL	NAME
C61,C62	SMOOTHING CAPACITOR	L61	REACTOR	RT68	OUTDOOR HEAT EXCHANGER TEMP. THERMISTOR
DB61	DIODE MODULE	MC	COMPRESSOR	TB	TERMINAL BLOCK
F701,F801,F901	FUSE (T3. 15AL250V)	MF	FAN MOTOR	T801	TRANSFORMER
H	DEFROST HEATER	PTC64, PTC65	CIRCUIT PROTECTION	X63, X64, X66	RELAY
IC700,IC820,IC932	POWER MODULE	RT61	DEFROST THERMISTOR	21S4	REVERSING VALVE COIL
IC802	POWER DEVICE	RT62	DISCHARGE TEMP. THERMISTOR	26H	HEATER PROTECTOR
LED	LED	RT64	FIN TEMP. THERMISTOR		
LEV	EXPANSION VALVE COIL	RT65	AMBIENT TEMP. THERMISTOR		

MUFZ-KJ15NAHZ MUFZ-KJ18NAHZ

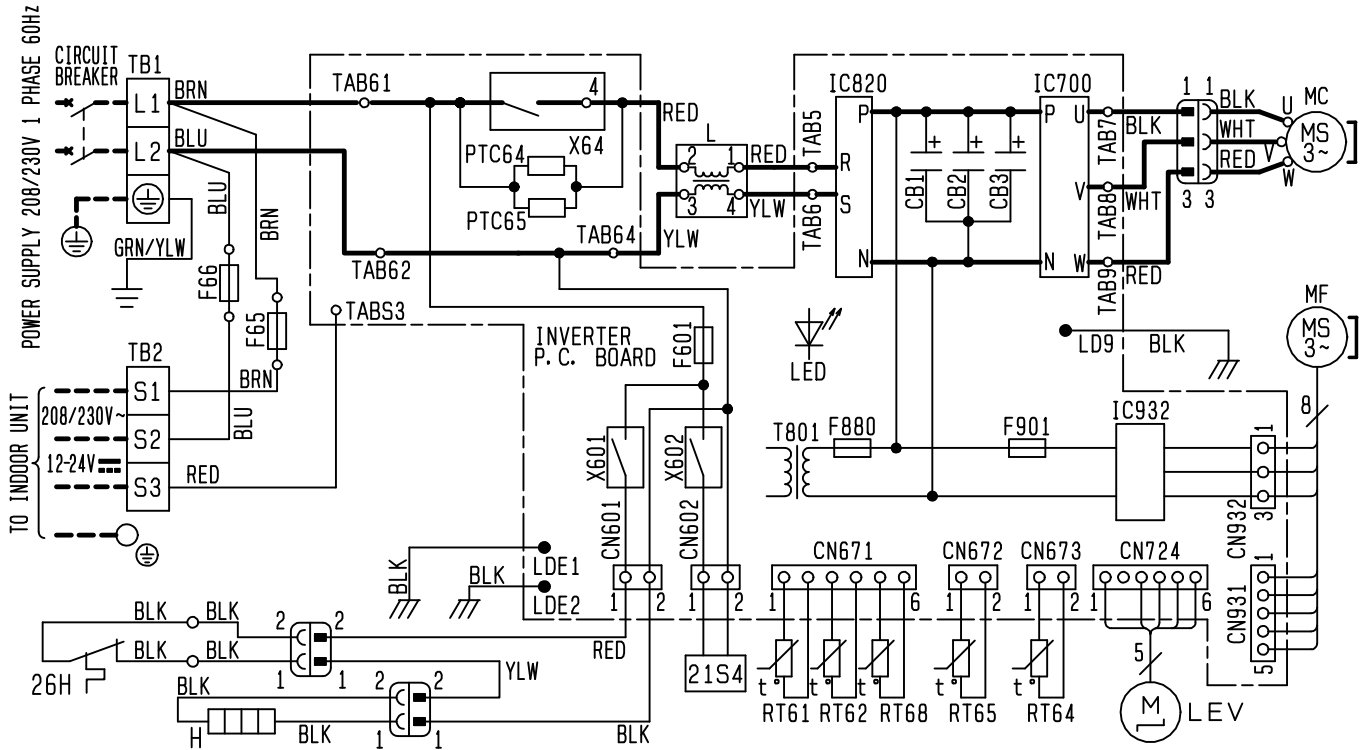

NOTES

1. About the indoor side electric wiring, refer to the indoor unit electric wiring diagram for servicing.
2. Use copper supply wires.
3. Symbols indicate, : Terminal block : Connector

REMARQUES

1. Pour le câblage électronique côté intérieur, se reporter au schéma d'entretien du câblage électronique de l'appareil intérieur.
2. Utiliser des fils d'alimentation en cuivre.
3. Les symboles ont les significations suivantes, : Borne : Connecteur

SYMBOL	NAME	SYMBOL	NAME	SYMBOL	NAME
CB1~3	SMOOTHING CAPACITOR	LED	LED	RT68	OUTDOOR HEAT EXCHANGER TEMP. THERMISTOR
F65, F66	FUSE (T6. 3AL250V)	LEV	EXPANSION VALVE COIL	TB1, TB2	TERMINAL BLOCK
F601	FUSE (T3. 15AL250V)	MC	COMPRESSOR	T801	TRANSFORMER
F880	FUSE (T3. 15AL250V)	PTC64	CIRCUIT PROTECTION	X601	RELAY
F901	FUSE (T3. 15AL250V)	PTC65	CIRCUIT PROTECTION	X602	RELAY
H	DEFROST HEATER	RT61	DEFROST THERMISTOR	X64	RELAY
IC700	IGBT MODULE	RT62	DISCHARGE TEMP. THERMISTOR	21S4	REVERSING VALVE COIL
IC820	DIODE MODULE	RT64	FIN TEMP. THERMISTOR	26H	HEATER PROTECTOR
IC932	IGBT MODULE	RT65	AMBIENT TEMP. THERMISTOR		
L	REACTOR				

MUFZ-KJ09NAHZ MUFZ-KJ12NAHZ

Unit: inch (mm)

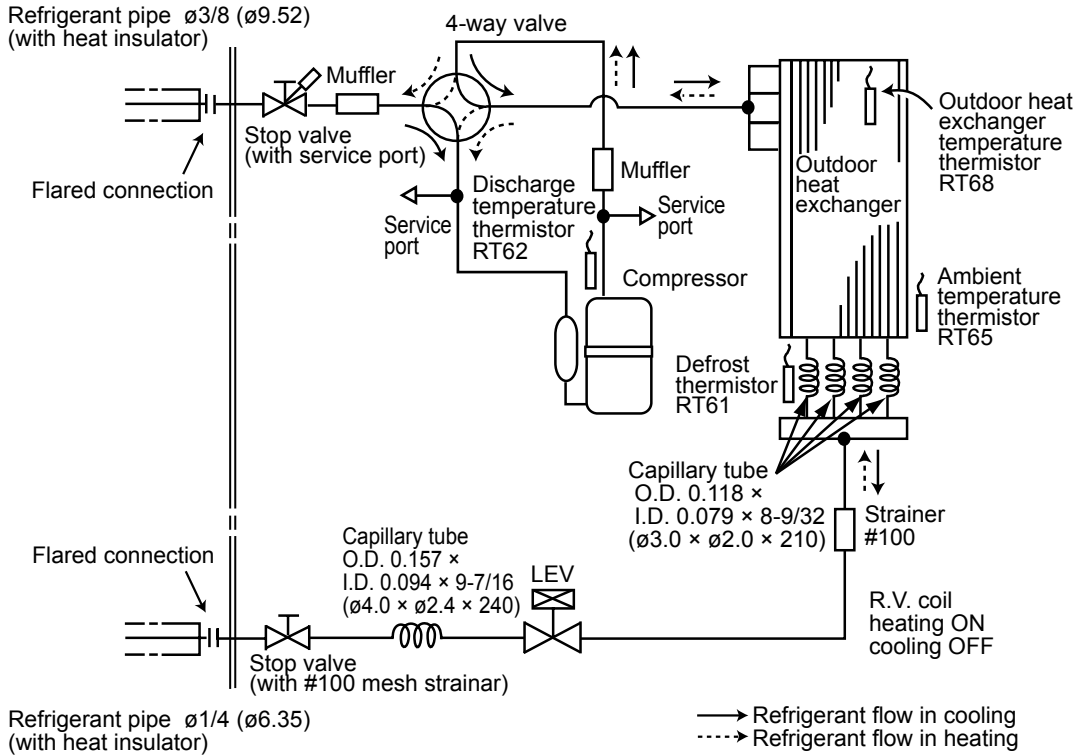

MUFZ-KJ15NAHZ MUFZ-KJ18NAHZ

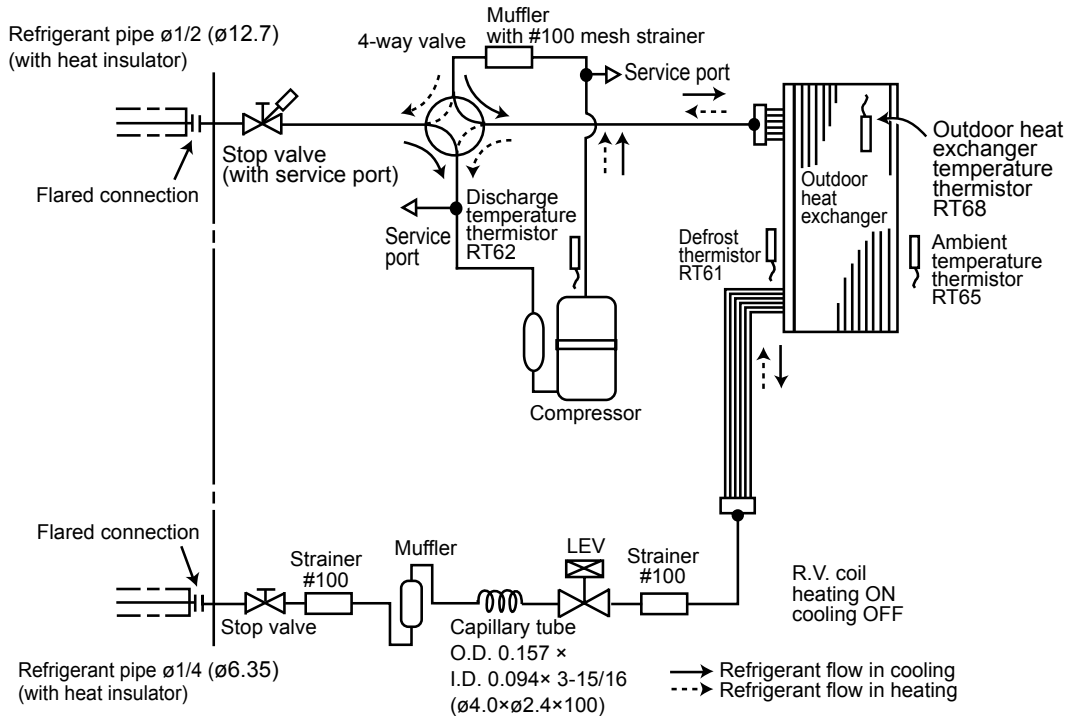

MAX. REFRIGERANT PIPING LENGTH and MAX. HEIGHT DIFFERENCE

Model	Refrigerant piping: ft.		Piping size O.D: in.	
	Max. Length A	Max. Height difference B	Gas	Liquid
MUFZ-KJ09NAHZ MUFZ-KJ12NAHZ	65	40	3/8	1/4
MUFZ-KJ15NAHZ MUFZ-KJ18NAHZ	100	50	1/2	1/4

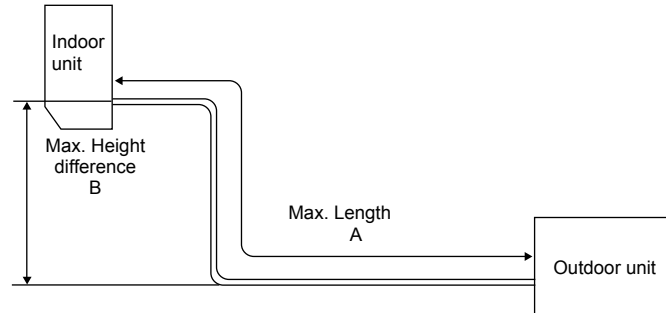

ADDITIONAL REFRIGERANT CHARGE (R410A: oz.)

NOTE: Refrigerant piping exceeding 25 ft. requires additional refrigerant charge according to the calculation.

Model	Outdoor unit precharged	Refrigerant piping length (one way): ft.					
		25	30	40	50	60	65
MUFZ-KJ09NAHZ MUFZ-KJ12NAHZ	2 lb. 10 oz.	0	1.08	3.24	5.40	7.56	8.64

Calculation: X oz. = 1.08/5 oz./ft. × (Refrigerant piping length (ft.) - 25)

NOTE: Refrigerant piping exceeding 25 ft. requires additional refrigerant charge according to the calculation.

Model	Outdoor unit precharged	Refrigerant piping length (one way): ft.								
		25	30	40	50	60	70	80	90	100
MUFZ-KJ15NAHZ MUFZ-KJ18NAHZ	3 lb. 5 oz.	0	1.62	4.86	8.10	11.34	14.58	17.82	21.06	24.30

Calculation: X oz. = 1.62/5 oz./ft. × (Refrigerant piping length (ft.) - 25)

MUFZ-KJ09NAHZ MUFZ-KJ12NAHZ MUFZ-KJ15NAHZ MUFZ-KJ18NAHZ

7-1. PERFORMANCE DATA

1) COOLING CAPACITY

Model	Indoor air IWB (°F)	Outdoor intake air DB temperature (°F)														
		75			85			95			105			115		
		TC	SHC	TPC	TC	SHC	TPC	TC	SHC	TPC	TC	SHC	TPC	TC	SHC	TPC
MUFZ-KJ09NAHZ	71	11.0	7.2	0.51	10.3	6.8	0.56	9.7	6.4	0.60	9.0	5.9	0.63	8.3	5.4	0.66
	67	10.4	8.2	0.48	9.7	7.7	0.53	9.0	7.1	0.57	8.4	6.6	0.60	7.7	6.1	0.63
	63	9.8	9.1	0.46	9.1	8.4	0.50	8.5	7.8	0.54	7.7	7.1	0.58	7.0	6.5	0.60
MUFZ-KJ12NAHZ	71	14.7	8.3	0.79	13.7	7.8	0.87	12.9	7.3	0.93	12.0	6.8	0.98	11.0	6.3	1.02
	67	13.9	9.7	0.75	13.0	9.1	0.82	12.0	8.4	0.89	11.2	7.8	0.94	10.3	7.2	0.99
	63	13.1	10.9	0.71	12.1	10.1	0.79	11.3	9.4	0.85	10.3	8.6	0.91	9.4	7.8	0.94
MUFZ-KJ15NAHZ	71	18.4	9.7	1.00	17.2	9.0	1.09	16.1	8.5	1.18	15.0	7.9	1.24	13.8	7.3	1.29
	67	17.4	11.5	0.94	16.2	10.7	1.04	15.0	9.9	1.12	14.0	9.2	1.19	12.8	8.5	1.24
	63	16.4	13.0	0.90	15.2	12.0	0.99	14.1	11.2	1.07	12.8	10.2	1.14	11.7	9.3	1.19
MUFZ-KJ18NAHZ	71	20.8	10.8	1.20	19.5	10.1	1.32	18.3	9.4	1.42	17.0	8.8	1.49	15.6	8.1	1.55
	67	19.7	12.8	1.13	18.4	11.9	1.25	17.0	11.1	1.35	15.8	10.3	1.43	14.5	9.4	1.50
	63	18.5	14.5	1.08	17.2	13.4	1.19	16.0	12.5	1.29	14.5	11.4	1.38	13.3	10.4	1.43

NOTE: 1. IWB : Intake air wet-bulb temperature TC : Total Capacity (x10³ Btu/h)
 SHC : Sensible Heat Capacity (x10³ Btu/h) TPC : Total Power Consumption (kW)
 2. SHC is based on 80°F of indoor Intake air DB temperature.

2) COOLING CAPACITY CORRECTIONS

	Refrigerant piping length (one way: ft.)			
	25 (std.)	40	65	100
MUFZ-KJ09NAHZ MUFZ-KJ12NAHZ	1.0	0.954	0.878	-
MUFZ-KJ15NAHZ MUFZ-KJ18NAHZ	1.0	0.954	0.878	0.771

3) HEATING CAPACITY

Model	Indoor air	Outdoor intake air WB temperature (°F)													
	IDB (°F)	5		15		25		35		43		45		55	
		TC	TPC	TC	TPC	TC	TPC	TC	TPC	TC	TPC	TC	TPC	TC	TPC
MUFZ-KJ09NAHZ	75	4.8	0.57	6.4	0.69	8.0	0.79	9.5	0.73	10.7	0.77	11.1	0.78	12.5	0.81
	70	5.2	0.55	6.8	0.67	8.3	0.77	9.7	0.71	11.0	0.75	11.3	0.77	12.8	0.80
	65	5.5	0.54	6.9	0.65	8.6	0.75	10.1	0.69	11.3	0.73	11.7	0.74	13.1	0.78
MUFZ-KJ12NAHZ	75	5.7	0.66	7.5	0.80	9.4	0.92	11.2	0.88	12.7	0.92	13.1	0.94	14.8	0.97
	70	6.2	0.64	8.0	0.78	9.8	0.90	11.5	0.86	13.0	0.90	13.4	0.92	15.1	0.95
	65	6.5	0.62	8.2	0.75	10.2	0.87	11.9	0.83	13.4	0.88	13.8	0.89	15.5	0.94
MUFZ-KJ15NAHZ	75	7.9	0.95	10.4	1.17	13.1	1.35	15.6	1.37	17.6	1.45	18.1	1.47	20.5	1.52
	70	8.6	0.92	11.1	1.14	13.5	1.33	15.9	1.34	18.0	1.41	18.5	1.44	21.0	1.49
	65	9.0	0.88	11.3	1.09	14.1	1.28	16.5	1.30	18.5	1.37	19.1	1.40	21.4	1.47
MUFZ-KJ18NAHZ	75	9.2	1.14	12.2	1.41	15.2	1.63	18.2	1.69	20.5	1.77	21.1	1.80	23.9	1.87
	70	10.0	1.10	12.9	1.37	15.8	1.60	18.6	1.64	21.0	1.73	21.6	1.76	24.5	1.83
	65	10.5	1.05	13.2	1.31	16.5	1.55	19.2	1.60	21.6	1.69	22.3	1.71	25.0	1.80

NOTE: 1. IDB : Intake air dry-bulb temperature
 TC : Total Capacity (x10³ Btu/h) TPC : Total Power Consumption (kW)
 2. Above data is for heating operation without any frost.

How to operate with fixed operational frequency of the compressor.

1. Press the EMERGENCY OPERATION switch on the front of the indoor unit, and select either EMERGENCY COOL mode or EMERGENCY HEAT mode before starting to operate the air conditioner.
2. The compressor starts with operational frequency.
3. The fan speed of the indoor unit is High.
4. This operation continues for 30 minutes.
5. In order to release this operation, press the EMERGENCY OPERATION switch twice or once, or press any button on the remote controller.

7-2. PERFORMANCE CURVE

Cooling

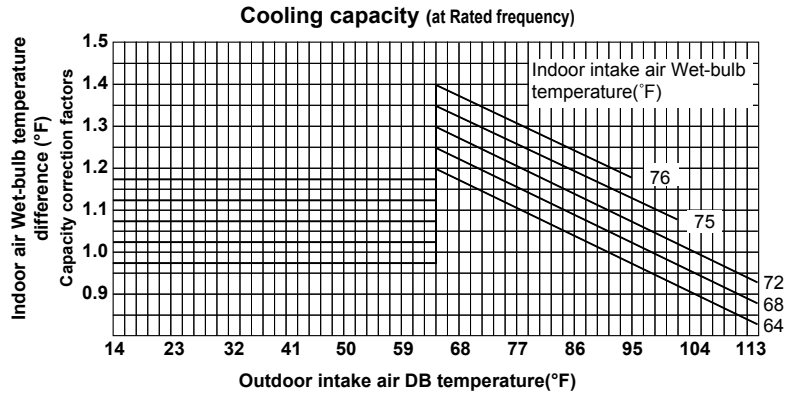

MUFZ-KJ09NAHZ

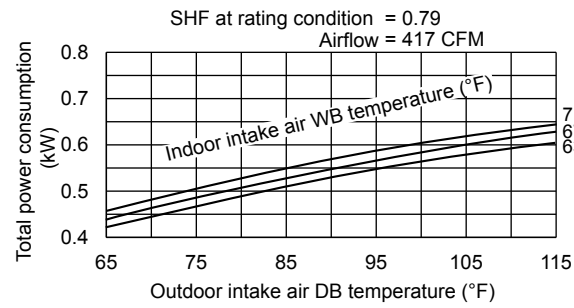

MUFZ-KJ12NAHZ

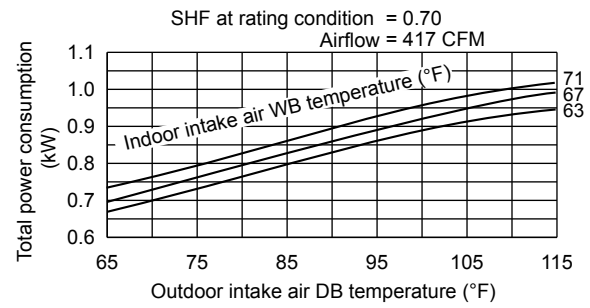

MUFZ-KJ15NAHZ

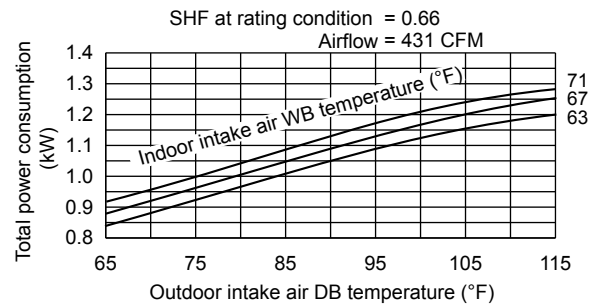

MUFZ-KJ18NAHZ

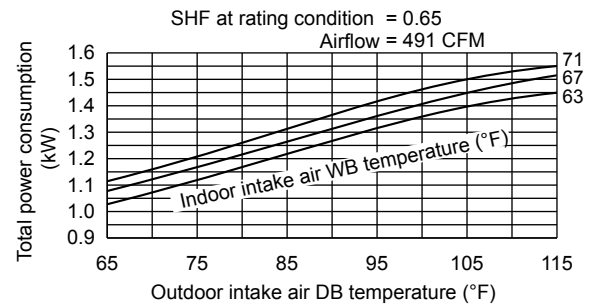

This value of frequency is not the same as the actual frequency in operating. Refer to 7-5 and 7-6 for the relationships between frequency and capacity.

Heating
MUFZ-KJ09NAHZ

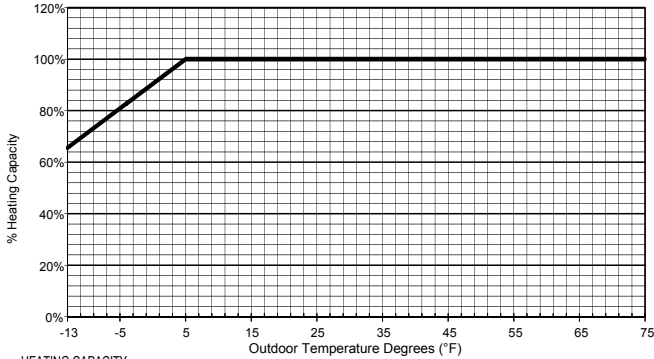

HEATING CAPACITY										
Outdoor Temperature Degrees (°F)	-13.0	-4.0	5.0	14.0	23.0	32.0	41.0	50.0	69.8	75.0
% Heating Capacity	66%	83%	100%	100%	100%	100%	100%	100%	100%	100%

MUFZ-KJ12NAHZ

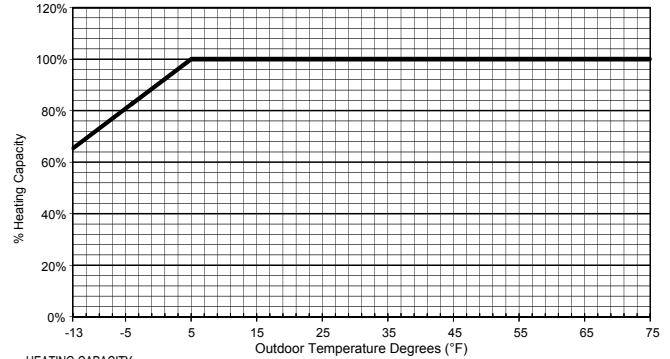

HEATING CAPACITY										
Outdoor Temperature Degrees (°F)	-13.0	-4.0	5.0	14.0	23.0	32.0	41.0	50.0	69.8	75.0
% Heating Capacity	65%	83%	100%	100%	100%	100%	100%	100%	100%	100%

MUFZ-KJ15NAHZ

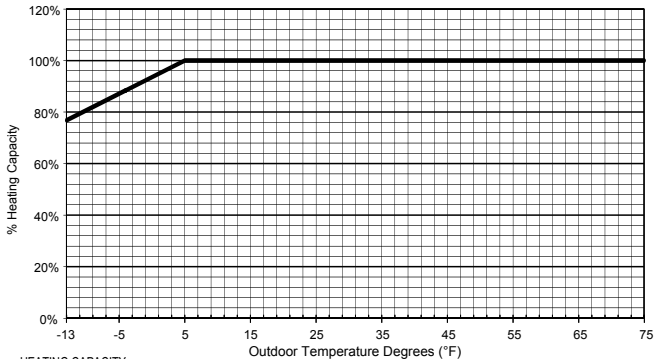

HEATING CAPACITY										
Outdoor Temperature Degrees (°F)	-13.0	-4.0	5.0	14.0	23.0	32.0	41.0	50.0	69.8	75.0
% Heating Capacity	77%	88%	100%	100%	100%	100%	100%	100%	100%	100%

MUFZ-KJ18NAHZ

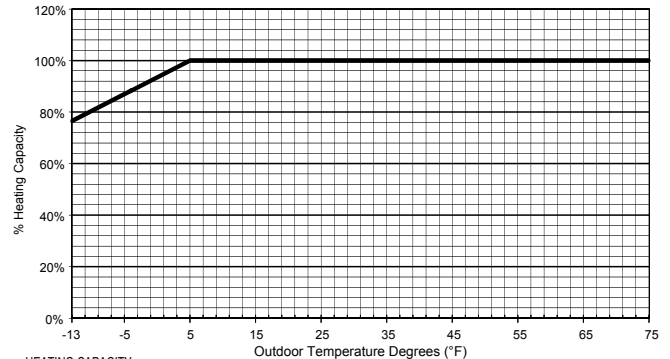

HEATING CAPACITY										
Outdoor Temperature Degrees (°F)	-13.0	-4.0	5.0	14.0	23.0	32.0	41.0	50.0	69.8	75.0
% Heating Capacity	77%	88%	100%	100%	100%	100%	100%	100%	100%	100%

MUFZ-KJ09NAHZ

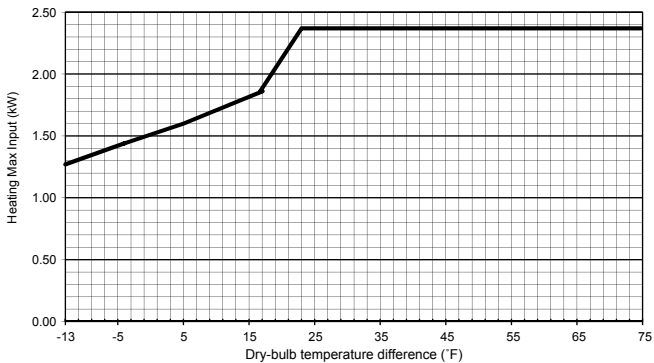

MUFZ-KJ12NAHZ

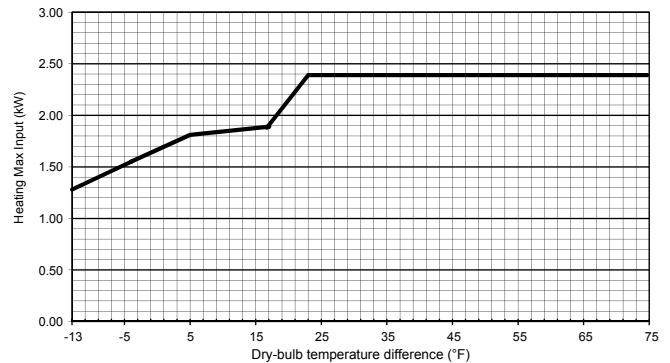

MUFZ-KJ15NAHZ

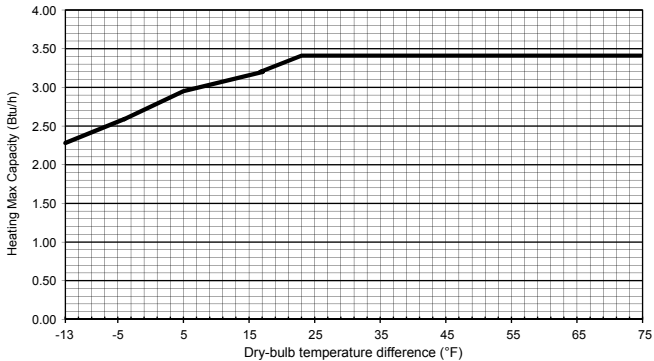

MUFZ-KJ18NAHZ

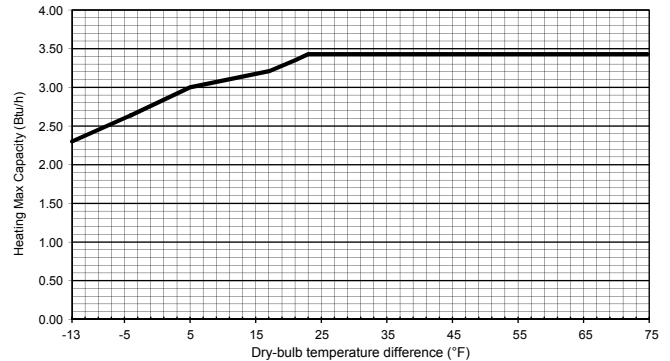

This value of frequency is not the same as the actual frequency in operating. Refer to 7-5 and 7-6 for the relationships between frequency and capacity.

7-3. CONDENSING PRESSURE

Cooling

Data are based on the condition of indoor humidity 50 %.

Air flow should be set to High speed.

MUFZ-KJ09NAHZ

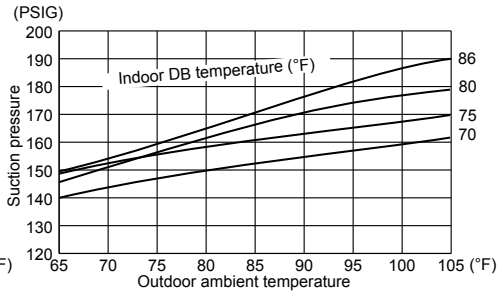
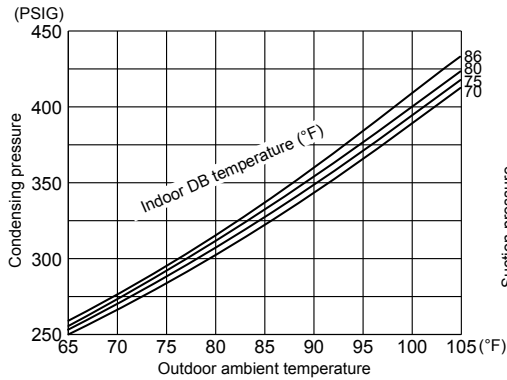

MUFZ-KJ12NAHZ

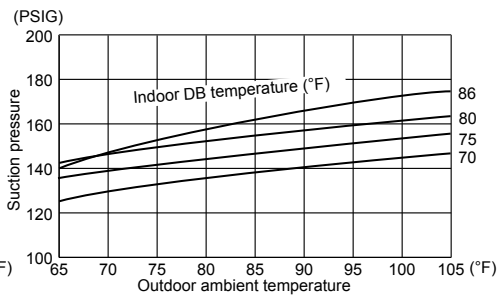
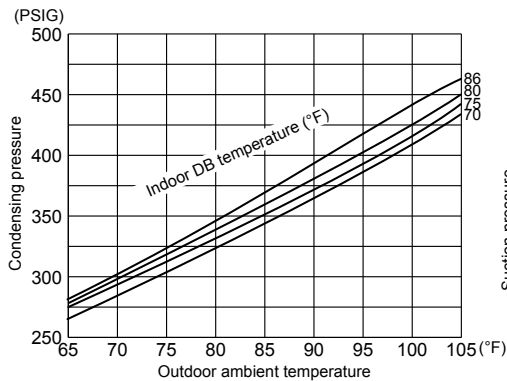

MUFZ-KJ15NAHZ

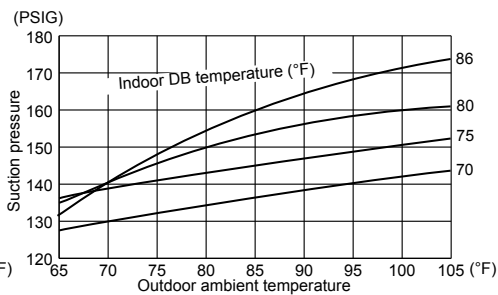
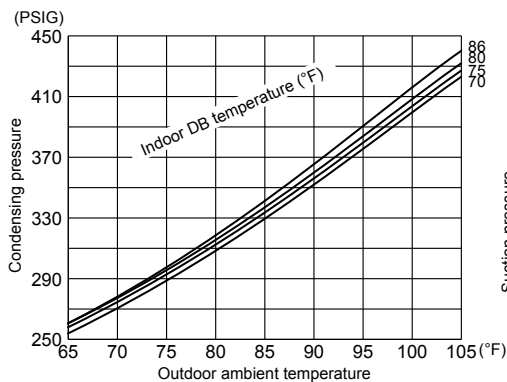

MUFZ-KJ18NAHZ

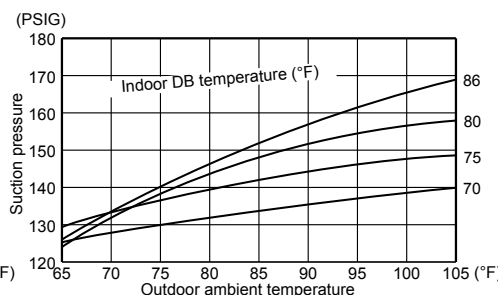
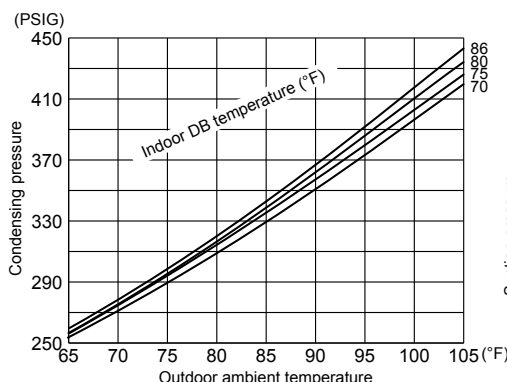

Heating

Data are based on the condition of outdoor humidity 75%.

Air flow should be set to High speed.

Data are for heating operation without any frost.

MUFZ-KJ09NAHZ

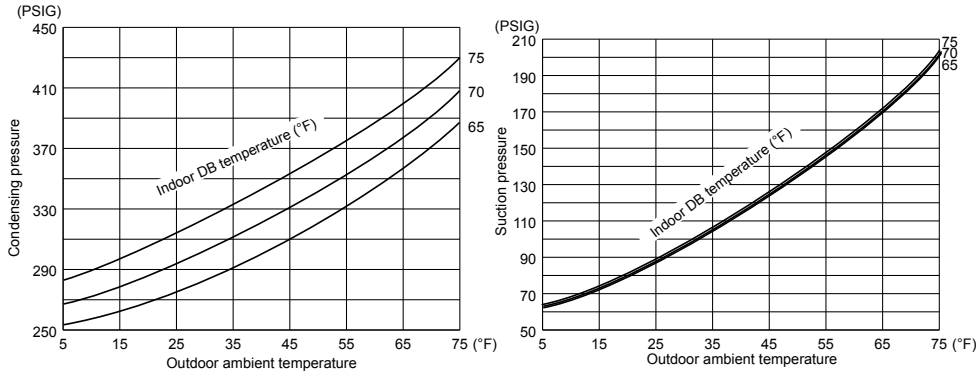

MUFZ-KJ12NAHZ

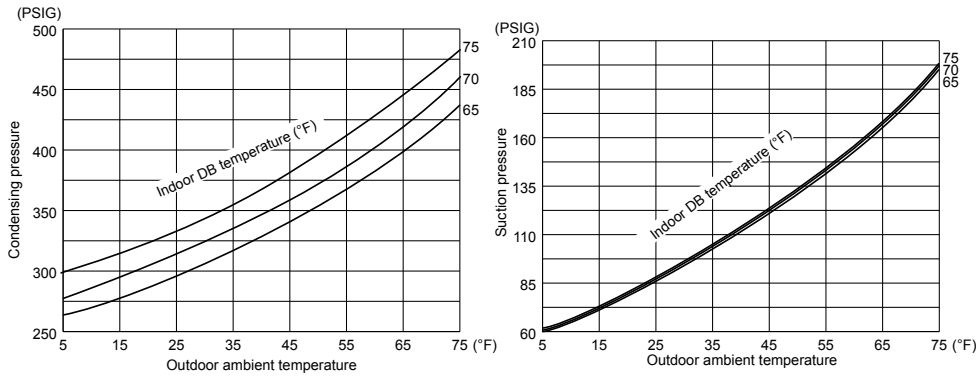

MUFZ-KJ15NAHZ

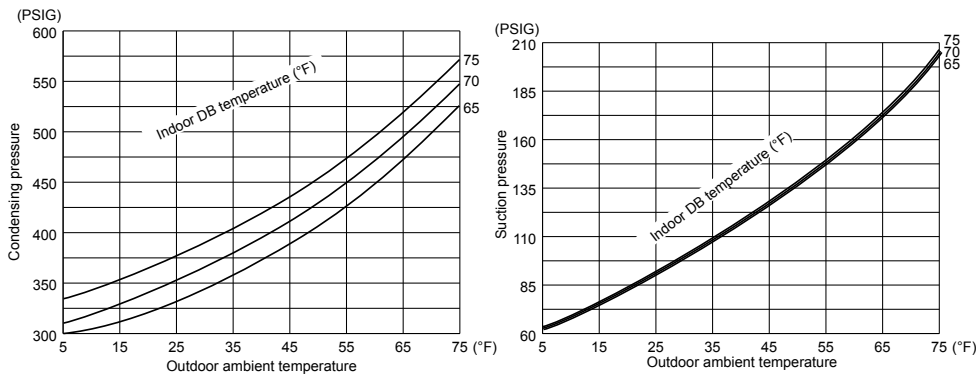

MUFZ-KJ18NAHZ

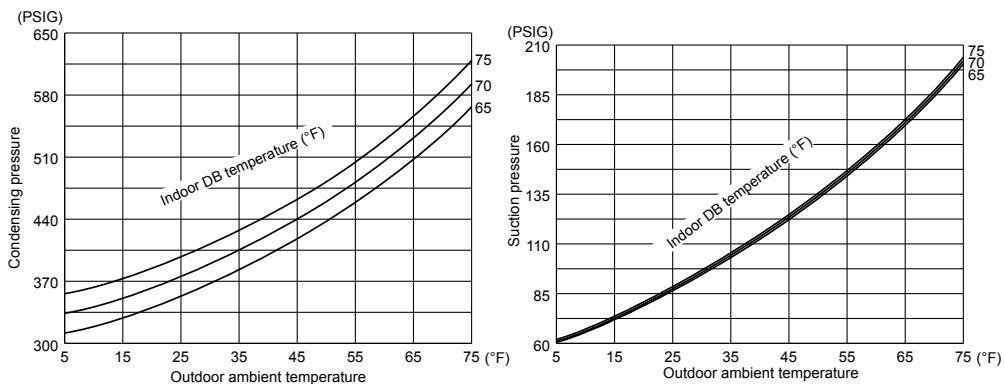

7-4. STANDARD OPERATION DATA

Model			MFZ-KJ09NA		MFZ-KJ12NA		MFZ-KJ15NA		MFZ-KJ18NA		
Item		Unit	Cooling	Heating	Cooling	Heating	Cooling	Heating	Cooling	Heating	
Total	Capacity	Btu/h	9,000	11,000	12,000	13,000	15,000	18,000	17,000	21,000	
	SHF	—	0.79	—	0.70	—	0.66	—	0.65	—	
	Input	kW	0.570	0.750	0.890	0.900	1.120	1.140	1.350	1.730	
	Rated frequency	Hz	33	45	46	53	48	57	56	62	
Indoor unit			MFZ-KJ09NA		MFZ-KJ12NA		MFZ-KJ15NA		MFZ-KJ18NA		
Power supply	V, phase, Hz	208/230, 1, 60									
Input	kW	0.025		0.025		0.027		0.047			
Fan motor current	A	0.26/0.23		0.26/0.23		0.28/0.35		0.48/0.43			
Outdoor unit			MUFZ-KJ09NAHZ		MUFZ-KJ12NAHZ		MUFZ-KJ15NAHZ		MUFZ-KJ18NAHZ		
Power supply	V, phase, Hz	208/230, 1, 60									
Input	kW	0.545	0.725	0.865	0.875	1.093	1.376	1.303	1.687		
Comp. current	A	2.21/2.00	3.09/2.79	3.75/3.39	3.81/3.45	4.05/3.63	5.38/4.86	5.05/4.54	6.87/6.22		
Fan motor current	A	0.41/0.37	0.40/0.36	0.41/0.37	0.40/0.36	1.21/1.09	1.24/1.12	1.21/1.09	1.24/1.12		
Refrigerant circuit	Condensing pressure	PSIG	377	331	401	360	382	414	388	441	
	Suction pressure	PSIG	172	126	159	121	158	127	154	124	
	Discharge temperature	°F	141	117	150	142	149	166	150	178	
	Condensing temperature	°F	109	98	113	104	110	112	111	117	
	Suction temperature	°F	60	37	52	36	55	38	51	41	
	Comp. shell bottom temperature	°F	131	109	141	132	140	156	143	168	
	Ref. pipe length	ft.	25								
	Refrigerant charge (R410A)		2 lb. 10oz				3 lb 5 oz.				
Indoor unit	Intake air temperature	DB	°F	80	70	80	70	80	70	80	70
		WB	°F	67	60	67	60	67	60	67	60
	Discharge air temperature	DB	°F	61	95	58	101	56	110	56	115
		WB	°F	60	—	57	—	55	—	55	—
	Fan speed (High)	rpm	1,080	1,080	1,080	1,080	1,110	1,200	1,240	1,200	
Airflow (High)	CFM	354 (Wet)	417	354 (Wet)	417	366 (Wet)	470	417 (Wet)	470		
Outdoor unit	Intake air temperature	DB	°F	95	47	95	47	95	47	95	47
		WB	°F	—	43	—	43	—	43	—	43
	Fan speed	rpm	810	900	810	900	820	860	820	860	
	Airflow	CFM	1,074	1,202	1,074	1,202	1,653	1,730	1,653	1,730	

7-5. CAPACITY AND INPUT CORRECTION BY INVERTER OUTPUT FREQUENCY

MUFZ-KJ09NAHZ

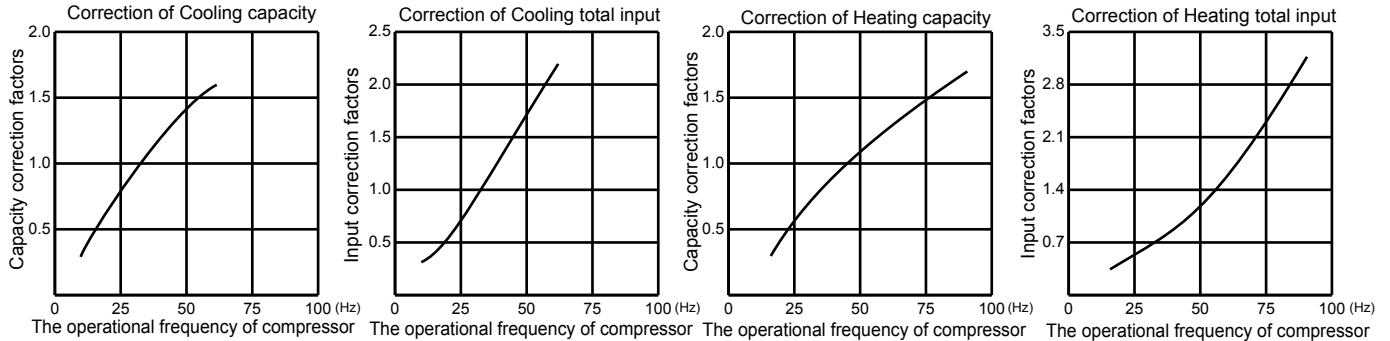

MUFZ-KJ12NAHZ

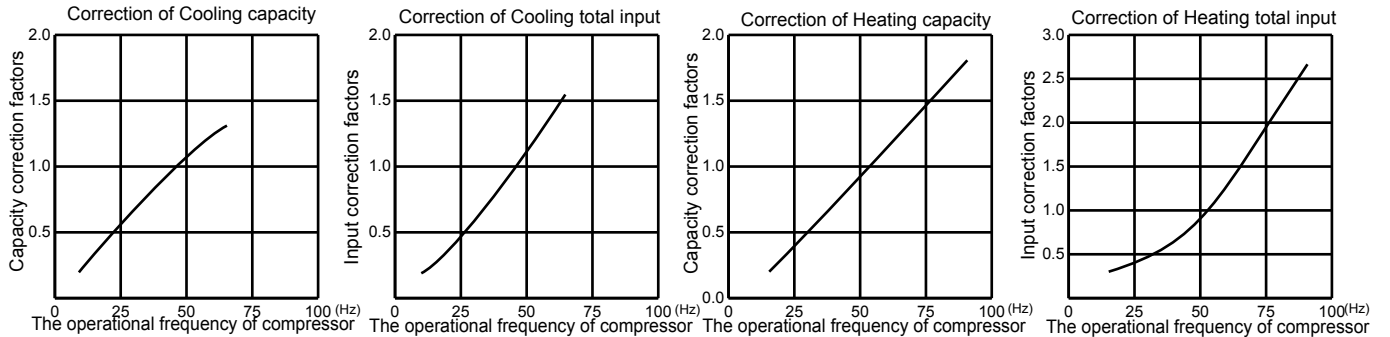

MUFZ-KJ15NAHZ

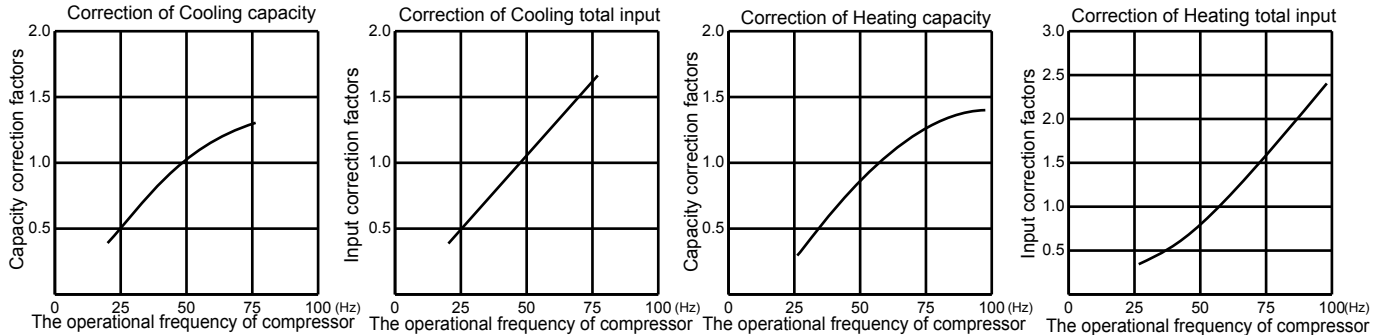

MUFZ-KJ18NAHZ

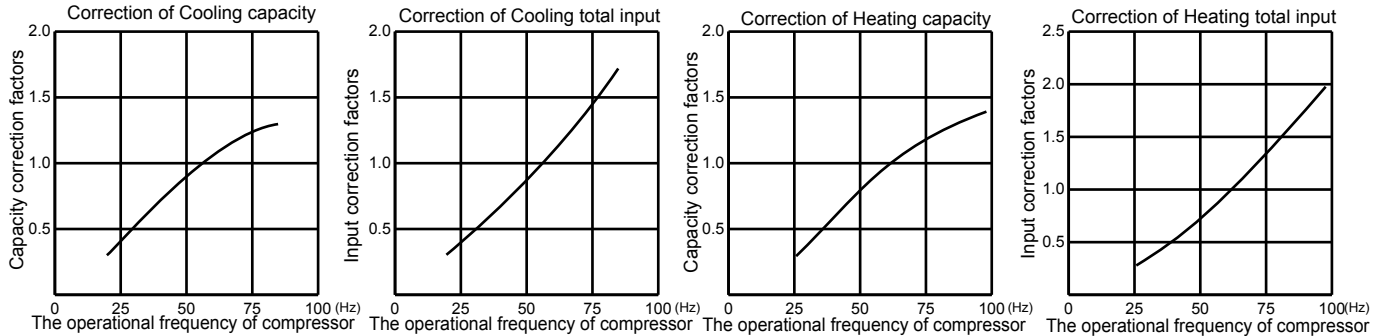

7-6. HOW TO OPERATE FIXED-FREQUENCY OPERATION (Test run operation)

1. Press EMERGENCY OPERATION switch to start COOL or HEAT mode (COOL: Press once, HEAT: Press twice).
2. Test run operation starts and continues to operate for 30 minutes.
3. Compressor operates at rated frequency in COOL mode or 58 Hz in HEAT mode. (Refer to 7-4.)
4. Indoor fan operates at High speed.
5. After 30 minutes, test run operation finishes and EMERGENCY OPERATION starts (operation frequency of compressor varies).
6. To cancel test run operation (EMERGENCY OPERATION), press EMERGENCY OPERATION switch or any button on remote controller.

MUFZ-KJ09NAHZ MUFZ-KJ12NAHZ MUFZ-KJ15NAHZ MUFZ-KJ18NAHZ

8-1. OUTDOOR FAN MOTOR CONTROL

The fan motor turns ON/OFF, interlocking with the compressor.

[ON] The fan motor turns ON 5 seconds before the compressor starts up.

[OFF] The fan motor turns OFF 15 seconds after the compressor has stopped running.

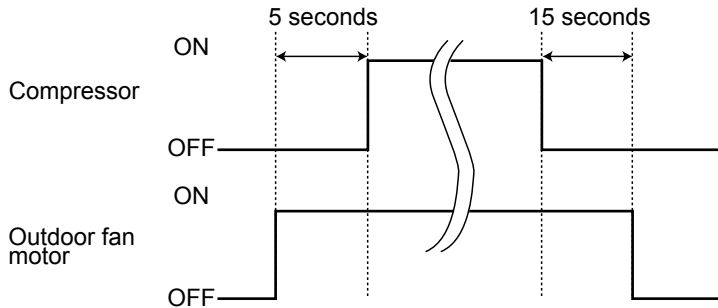

8-2. R.V. COIL CONTROL

Heating ON

Cooling OFF

Dry OFF

NOTE: The 4-way valve reverses for 5 seconds right before start-up of the compressor.

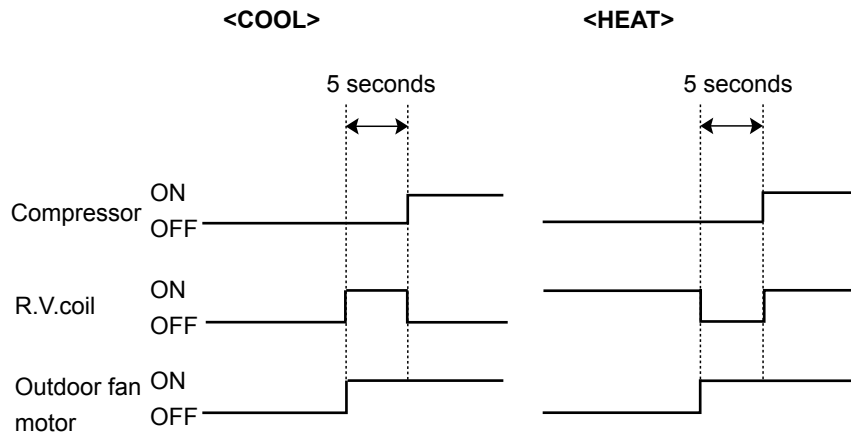

8-3. RELATION BETWEEN MAIN SENSOR AND ACTUATOR

Sensor	Purpose	Actuator					
		Compressor	LEV	Outdoor fan motor	R.V.coil	Indoor fan motor	Defrost heater
Discharge temperature thermistor	Protection	○	○				
Indoor coil temperature thermistor	Cooling: Coil frost prevention	○					
	Heating: High pressure protection	○	○				
Defrost thermistor	Heating: Defrosting	○	○	○	○	○	
Fin temperature thermistor	Protection	○		○			
Ambient temperature thermistor	Cooling: Low ambient temperature operation	○	○	○			
	Heating: Defrosting (Heater)						○
Outdoor heat exchanger temperature thermistor	Cooling: Low ambient temperature operation	○	○	○			
	Cooling: High pressure protection	○	○	○			

MUFZ-KJ09NAHZ MUFZ-KJ12NAHZ MUFZ-KJ15NAHZ MUFZ-KJ18NAHZ**9-1. CHANGE IN DEFROST SETTING****Changing defrost finish temperature**

<JS> To change the defrost finish temperature, cut/solder the JS wire of the outdoor inverter P.C. board (Refer to 10-6.1.).

Jumper		Defrost finish temperature	
		MUFZ-KJ09/12NAHZ	MUFZ-KJ15/18NAHZ
JS	Soldered (Initial setting)	41°F (5°C)	50°F (10°C)
	None (Cut)	50°F (10°C)	64°F (18°C)

9-2. PRE-HEAT CONTROL SETTING**MUFZ-KJ09/12**

When moisture gets into the refrigerant cycle, it may interfere with the start-up of the compressor at low outside temperature. The pre-heat control prevents this interference. The pre-heat control turns ON when the discharge temperature thermostat is 68°F (20°C) or below. When the pre-heat control turns ON, the compressor is energized. (About 50 W)

MUFZ-KJ15/18

Prolonged low load operation, in which the thermostat is OFF for a long time, at low outside temperature [32°F (0°C) or less] may cause the following troubles. The pre-heat control prevents this interference.

- 1) If moisture gets into the refrigerant cycle and freezes, it may interfere the start-up of the compressor.
- 2) If liquid refrigerant collects in the compressor, a failure in the compressor may occur.

The pre-heat control turns ON when the compressor temperature is 68°F (20°C) or below. When the pre-heat control turns ON, the compressor is energized. (About 70 W)

Pre-heat control setting

<JK>

ON: To activate the pre-heat control, cut JK wire of the inverter P.C. board.

OFF: To deactivate the pre-heat control, solder JK wire of the inverter P.C. board.

(Refer to 10-6.1)

Jumper		Pre-heat control setting	
		MUFZ-KJ09/12NAHZ	MUFZ-KJ15/18NAHZ
JK	Soldered	Deactivated (Initial setting)	Deactivated (Initial setting)
	Cut	Activated	Activated

NOTE: When the inverter P.C. board is replaced, check the jumper wires, and cut/solder them if necessary.

MUFZ-KJ09NAHZ MUFZ-KJ12NAHZ MUFZ-KJ15NAHZ MUFZ-KJ18NAHZ

10-1. CAUTIONS ON TROUBLESHOOTING

1. Before troubleshooting, check the following

- 1) Check the power supply voltage.
- 2) Check the indoor/outdoor connecting wire for miswiring.

2. Take care of the following during servicing

- 1) Before servicing the air conditioner, be sure to turn OFF the main unit first with the remote controller, then after confirming the horizontal vane is closed, turn off the breaker and/or disconnect the power plug.
- 2) Be sure to turn OFF the power supply before removing the front panel, the cabinet, the top panel, and the electronic control P.C. board.
- 3) When removing the electrical parts, be careful of the residual voltage of smoothing capacitor.
- 4) When removing the electronic control P.C. board, hold the edge of the board with care NOT to apply stress on the components.
- 5) When connecting or disconnecting the connectors, hold the connector housing. DO NOT pull the lead wires.

<Incorrect>

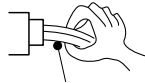

Lead wiring

<Correct>

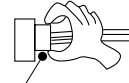

Connector housing

3. Troubleshooting procedure

- 1) Check if the OPERATION INDICATOR lamp on the indoor unit is flashing on and off to indicate an abnormality. To make sure, check how many times the OPERATION INDICATOR lamp is flashing on and off before starting service work.
- 2) Before servicing, check that the connector and terminal are connected properly.
- 3) When the electronic control P.C. board seems to be defective, check the copper foil pattern for disconnection and the components for bursting and discoloration.
- 4) Refer to 10-2 and 10-3.

10-2. FAILURE MODE RECALL FUNCTION

Outline of the function

This air conditioner can memorize the abnormal condition which has occurred once.

Even though LED indication listed on the troubleshooting check table (10-3.) disappears, the memorized failure details can be recalled.

1. Flow chart of failure mode recall function for the indoor/outdoor unit

Operational procedure

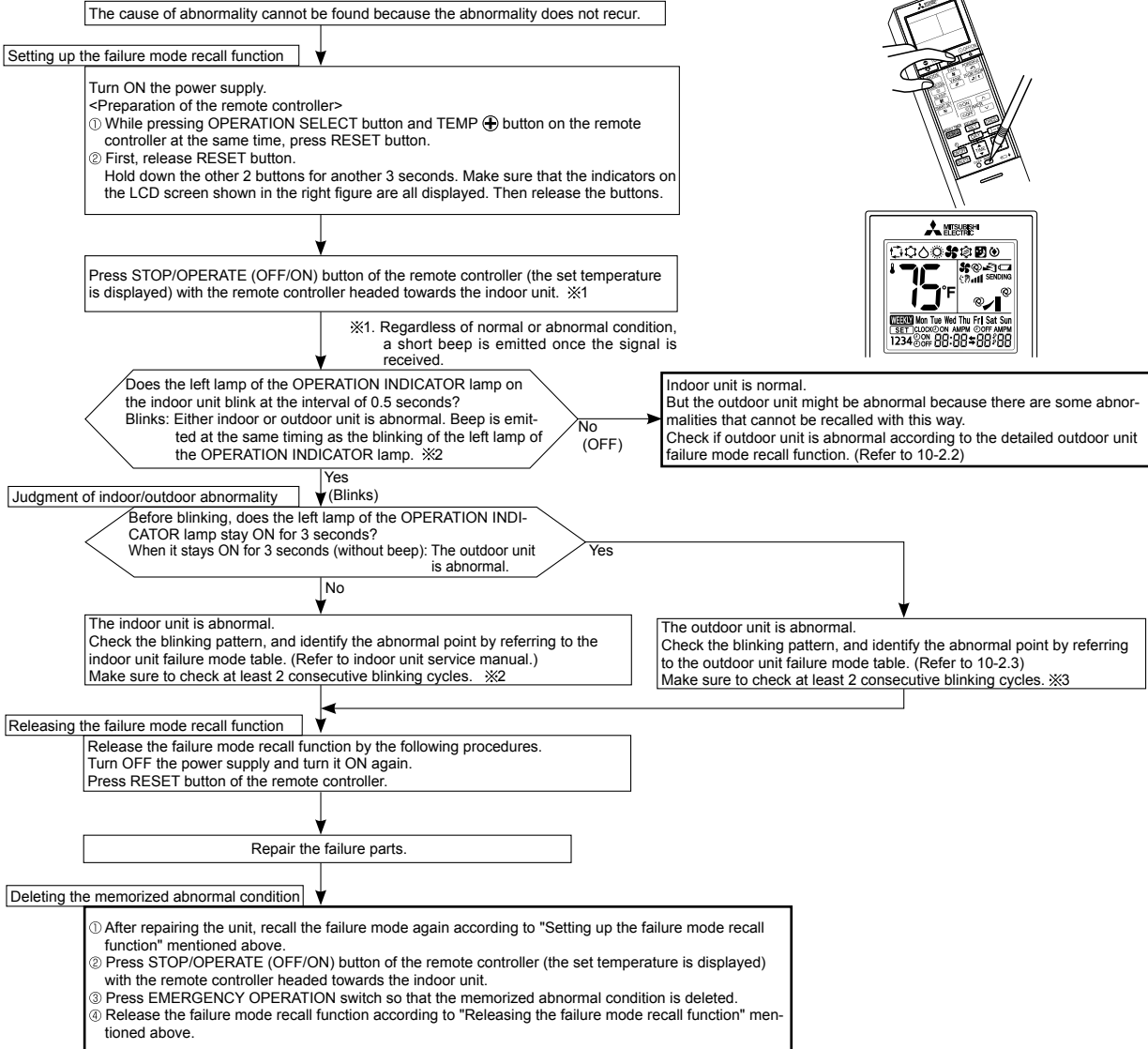

NOTE: 1. Make sure to release the failure mode recall function after it is set up, otherwise the unit cannot operate properly.
2. If the abnormal condition is not deleted from the memory, the last abnormal condition is kept memorized.

※2. Blinking pattern when the indoor unit is abnormal:

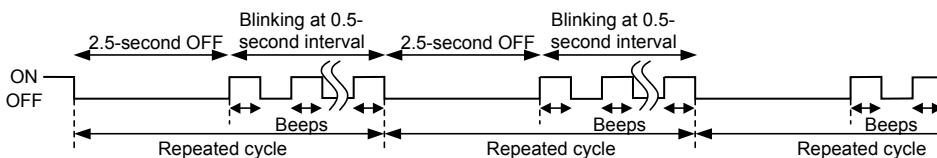

※3. Blinking pattern when the outdoor unit is abnormal:

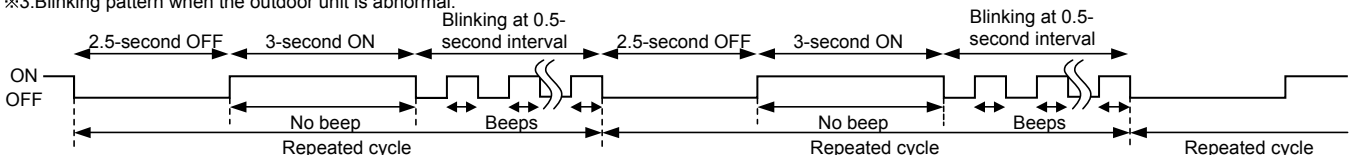

2. Flow chart of the detailed outdoor unit failure mode recall function

Operational procedure

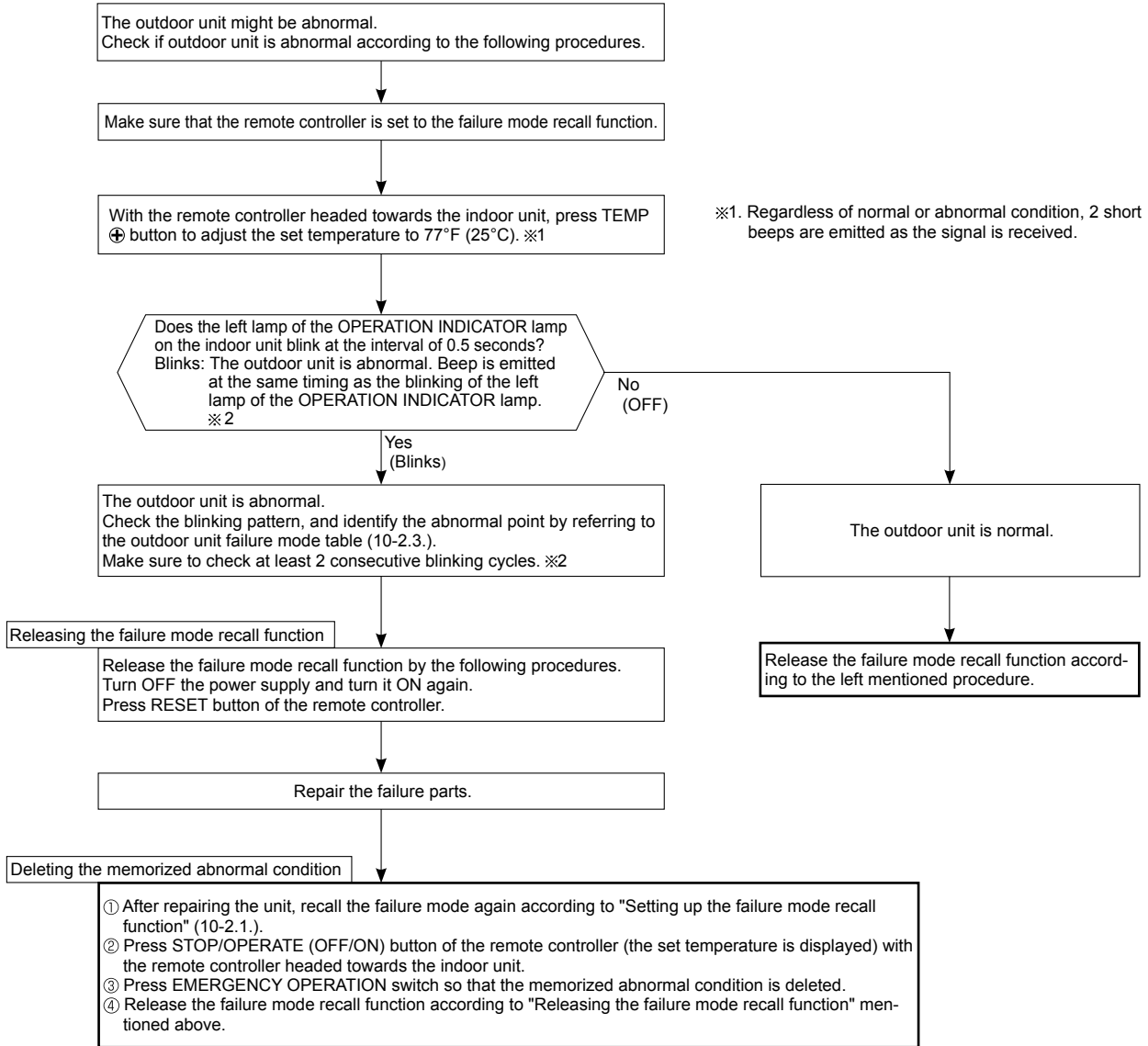

NOTE: 1. Make sure to release the failure mode recall function after it is set up, otherwise the unit cannot operate properly.
2. If the abnormal condition is not deleted from the memory, the last abnormal condition is kept memorized.

※2. Blinking pattern when outdoor unit is abnormal:

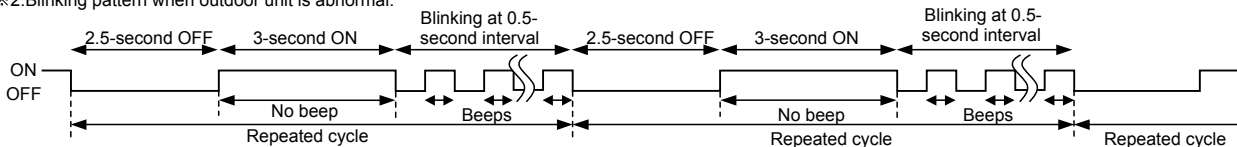

3. Outdoor unit failure recall mode table

The left lamp of the OPERATION INDICATOR lamp (Indoor unit)	Abnormal point (Failure mode/protection)	LED indication (Outdoor P.C. board)	Condition	Remedy	Indoor/outdoor unit failure mode recall function	Outdoor unit failure mode recall function
OFF	None (Normal)	—	—	—	—	—
1-time flash 2.5 seconds OFF	Indoor/outdoor communication, receiving error	—	Any signals from the inverter P.C. board cannot be received normally for 3 minutes.	•Refer to 10-5. ㉞ How to check miswiring and serial signal error.	○	○
	Indoor/outdoor communication, receiving error	—	Although the inverter P.C. board sends signal "0", signal "1" has been received 30 consecutive times.	•Refer to 10-5. ㉞ How to check miswiring and serial signal error.		
2-time flash 2.5 seconds OFF	Outdoor power system	—	Overcurrent protection cut-out operates 3 consecutive times within 1 minute after the compressor gets started.	•Reconnect connectors. •Refer to 10-5. ㉞ How to check inverter/compressor". •Check stop valve.	○	○
3-time flash 2.5 seconds OFF	Discharge temperature thermistor	1-time flash every 2.5 seconds	Thermistor shorts or opens during compressor running.	•Refer to 10-5. ㉞ "Check of outdoor thermistors". Defective outdoor thermistors can be identified by checking the blinking pattern of LED.	○	○
	Defrost thermistor	—				
	Fin temperature thermistor	3-time flash 2.5 seconds OFF				
	P.C. board temperature thermistor	4-time flash 2.5 seconds OFF				
	Ambient temperature thermistor	2-time flash 2.5 seconds OFF				
Outdoor heat exchanger temperature thermistor	—					
4-time flash 2.5 seconds OFF	Overcurrent	11-time flash 2.5 seconds OFF	Large current flows into the power module (IC700) (KJ09/12)/ IGBT module (IC700) (KJ15/18).	•Reconnect compressor connector. •Refer to 10-5. ㉞ How to check inverter/compressor". •Check stop valve.	—	○
	Compressor synchronous abnormality (Compressor start-up failure protection)	12-time flash 2.5 seconds OFF	Waveform of compressor current is distorted.	•Reconnect compressor connector. •Refer to 10-5. ㉞ How to check inverter/compressor".	—	○
5-time flash 2.5 seconds OFF	Discharge temperature	—	Temperature of discharge temperature thermistor exceeds 241°F (116°C), compressor stops. Compressor can restart if discharge temperature thermistor reads 212°F (100°C) or less 3 minutes later.	•Check refrigerant circuit and refrigerant amount. •Refer to 10-5. ㉞ Check of LEV".	—	○
6-time flash 2.5 seconds OFF	High pressure	—	Temperature indoor coil thermistor exceeds 158°F (70°C) in HEAT mode. Temperature defrost thermistor exceeds 158°F (70°C) in COOL mode.	•Check refrigerant circuit and refrigerant amount. •Check stop valve.	—	○
7-time flash 2.5 seconds OFF	Fin temperature/ P.C. board temperature	7-time flash 2.5 seconds OFF	Temperature of the fin temperature thermistor on the inverter P.C. board exceeds 167 - 187°F (75 - 86°C) (KJ09/12)/167 - 176°F (75 - 80°C) (KJ15/18), or temperature of P.C. board temperature thermistor on the inverter P.C. board exceeds 162 - 185°F (72 - 85°C) (KJ09/12)/158 - 167°F (70 - 75°C) (KJ15/18).	•Check around outdoor unit. •Check outdoor unit air passage. •Refer to 10-5. ㉞ Check of outdoor fan motor".	—	○
8-time flash 2.5 seconds OFF	Outdoor fan motor	—	Outdoor fan has stopped 3 times in a row within 30 seconds after outdoor fan start-up.	•Refer to 10-5. ㉞ Check of outdoor fan motor". Refer to 10-5. ㉞ Check of inverter P.C. board".	—	○
9-time flash 2.5 seconds OFF	Nonvolatile memory data	5-time flash 2.5 seconds OFF	Nonvolatile memory data cannot be read properly.	•Replace the inverter P.C. board.	○	○
	Power module (IC700) (KJ09/12) IGBT module (IC700) (KJ15/18)	6-time flash 2.5 seconds OFF	The interface short circuit occurs in the output of the power module (IC700) (KJ09/12)/IGBT module (IC700) (KJ15/18). The compressor winding shorts circuit.	•Refer to 10-5. ㉞ How to check inverter/compressor".		

NOTE: Blinking patterns of this mode differ from the ones of TROUBLESHOOTING CHECK TABLE (10-3.).

The left lamp of the OPERATION INDICATOR lamp (Indoor unit)	Abnormal point (Failure mode/protection)	LED indication (Outdoor P.C. board)	Condition	Remedy	Indoor/outdoor unit failure mode recall function	Outdoor unit failure mode recall function
10-time flash 2.5 seconds OFF	Discharge temperature	—	Temperature of discharge temperature thermistor has been 122°F (50°C) or less for 20 minutes.	•Refer to 10-5.Ⓒ"Check of LEV". •Check refrigerant circuit and refrigerant amount.	—	○
11-time flash 2.5 seconds OFF	DC voltage	8-time flash 2.5 seconds OFF	DC voltage of inverter cannot be detected normally.	•Refer to 10-5.Ⓐ"How to check inverter/compressor".	—	○
	Each phase current of compressor	9-time flash 2.5 seconds OFF	Each phase current of compressor cannot be detected normally.			
14-time flash or more 2.5 seconds OFF	Stop valve (Closed valve)	14-time flash 2.5 seconds OFF	Closed valve is detected by compressor current.	•Check stop valve.	○	○
	4-way valve/ Pipe temperature	16-time flash 2.5 seconds OFF	The 4-way valve does not work properly. The indoor coil thermistor detects an abnormal temperature.	•Check the 4-way valve. •Replace the inverter P.C. board.		
	Outdoor refrigerant system abnormality	17-time flash 2.5 seconds OFF	A closed valve and air trapped in the refrigerant circuit are detected based on the temperature sensed by the indoor and outdoor thermistors and the current of the compressor.	•Check for a gas leak in a connecting piping etc. •Check the stop valve. •Refer to 10-5. Ⓒ "Check of outdoor refrigerant circuit".		

NOTE: Blinking patterns of this mode differ from the ones of TROUBLESHOOTING CHECK TABLE (10-3.).

10-3. TROUBLESHOOTING CHECK TABLE

No.	Symptom	LED indication	Abnormal point/Condition	Condition	Remedy
1	Outdoor unit does not operate.	1-time flash every 2.5 seconds	Outdoor power system	Overcurrent protection cut-out operates 3 consecutive times within 1 minute after the compressor gets started.	<ul style="list-style-type: none"> •Reconnect connector of compressor. •Refer to 10-5.Ⓐ "How to check inverter/compressor". •Check stop valve.
2			Outdoor thermistors	Discharge temperature thermistor, fin temperature thermistor, defrost thermistor, P.C. board temperature thermistor, outdoor heat exchanger temperature thermistor or ambient temperature thermistor shorts or opens during compressor running.	•Refer to 10-5.Ⓒ "Check of outdoor thermistors".
3			Outdoor control system	Nonvolatile memory data cannot be read properly. (The left lamp of the OPERATION INDICATOR lamp on the indoor unit lights up or flashes 7-time.)	•Replace inverter P.C. board.
4		6-time flash 2.5 seconds OFF	Serial signal	The communication fails between the indoor and outdoor unit for 3 minutes.	<ul style="list-style-type: none"> •Check connection between the inverter P.C. board and the relay P.C. board. (KJ15/18) •Refer to 10-5.Ⓜ "How to check miswiring and serial signal error."
5		11-time flash 2.5 seconds OFF	Stop valve/ Closed valve	Closed valve is detected by compressor current.	•Check stop valve.
6		16-time flash 2.5 seconds OFF	4-way valve/ Pipe temperature	The 4-way valve does not work properly. The indoor coil thermistor detects an abnormal temperature.	<ul style="list-style-type: none"> •Refer to 10-5.Ⓣ "Check of R.V. coil". •Replace the inverter P.C. board.
7		17-time flash 2.5 seconds OFF	Outdoor refrigerant system abnormality	A closed valve and air trapped in the refrigerant circuit are detected based on the temperature sensed by the indoor and outdoor thermistors and the current of the compressor.	<ul style="list-style-type: none"> •Check for a gas leak in a connecting piping etc. •Check the stop valve. •Refer to 10-5.Ⓢ "Check of outdoor refrigerant circuit".
8	'Outdoor unit stops and restarts 3 minutes later' is repeated.	2-time flash 2.5 seconds OFF	Overcurrent protection	Large current flows into the power module (IC700) (KJ09/12)/ IGBT module (IC700) (KJ15/18).	<ul style="list-style-type: none"> •Reconnect connector of compressor. •Refer to 10-5.Ⓐ "How to check inverter/compressor". •Check stop valve.
9		3-time flash 2.5 seconds OFF	Discharge temperature overheat protection	Temperature of discharge temperature thermistor exceeds 241°F (116°C), compressor stops. Compressor can restart if discharge temperature thermistor reads 212°F (100°C) or less 3 minutes later.	<ul style="list-style-type: none"> •Check refrigerant circuit and refrigerant amount. •Refer to 10-5.Ⓢ "Check of LEV".
10		4-time flash 2.5 seconds OFF	Fin temperature /P.C. board temperature thermistor overheat protection	Temperature of the fin temperature thermistor on the heat sink exceeds 167 - 187°F (75 - 86°C) (KJ09/12)/167 - 176°F (75 - 80°C) (KJ15/18) or temperature of P.C. board temperature thermistor on the inverter P.C. board exceeds 162 - 185°F (72 - 85°C) (KJ09/12)/158 - 167°F (70 - 75°C) (KJ15/18).	<ul style="list-style-type: none"> •Check around outdoor unit. •Check outdoor unit air passage. •Refer to 10-5.Ⓛ "Check of outdoor fan motor".
11		5-time flash 2.5 seconds OFF	High pressure protection	Indoor coil thermistor exceeds 158°F (70°C) in HEAT mode. Defrost thermistor exceeds 158°F (70°C) in COOL mode.	<ul style="list-style-type: none"> •Check refrigerant circuit and refrigerant amount. •Check stop valve.
12		8-time flash 2.5 seconds OFF	Compressor synchronous abnormality	The waveform of compressor current is distorted.	<ul style="list-style-type: none"> •Reconnect connector of compressor. •Refer to 10-5.Ⓐ "How to check inverter/compressor".
13		10-time flash 2.5 seconds OFF	Outdoor fan motor	Outdoor fan has stopped 3 times in a row within 30 seconds after outdoor fan start-up.	<ul style="list-style-type: none"> •Refer to 10-5.Ⓛ "Check of outdoor fan motor." •Refer to 10-5.Ⓛ "Check of inverter P.C. board."
14		12-time flash 2.5 seconds OFF	Each phase current of compressor	Each phase current of compressor cannot be detected normally.	•Refer to 10-5.Ⓐ "How to check inverter/compressor".
15		13-time flash 2.5 seconds OFF	DC voltage	DC voltage of inverter cannot be detected normally.	<ul style="list-style-type: none"> •It occurs with following case. Instantaneous power voltage drop. (Short time power failure) (KJ15/18) •Refer to 10-5.Ⓢ "Check of power supply". (KJ15/18) •Refer to 10-5.Ⓐ "How to check inverter/compressor".

NOTE: 1. The location of LED is illustrated at the right figure. Refer to 10-6.1.
2. LED is lighted during normal operation.

The flashing frequency shows the number of times the LED blinks after every 2.5-second OFF.
(Example) When the flashing frequency is "2".

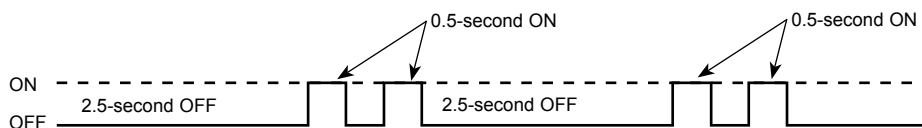

Inverter P.C. board
MUFZ-KJ09/12NAHZ

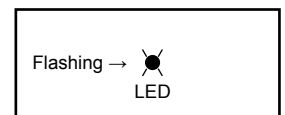

MUFZ-KJ15/18NAHZ

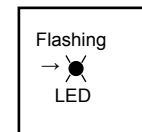



No.	Symptom	LED indication	Abnormal point/Condition	Condition		Remedy
16	Outdoor unit operates.	1-time flash 2.5 seconds OFF	Frequency drop by current protection	KJ09/12	When the input current exceeds approximately 10A (KJ09)/10.5A (FH12), compressor frequency lowers.	The unit is normal, but check the following. •Check if indoor filters are clogged. •Check if refrigerant is short. •Check if indoor/outdoor unit air circulation is short cycled.
				KJ15/18	Current from power outlet is nearing breaker capacity.	
17		3-time flash 2.5 seconds OFF	Frequency drop by high pressure protection	Temperature of indoor coil thermistor exceeds 131 °F (55°C) in HEAT mode, compressor frequency lowers.		
				Frequency drop by defrosting in COOL mode	Indoor coil thermistor reads 46°F (8°C) or less in COOL mode, compressor frequency lowers.	
18		4-time flash 2.5 seconds OFF	Frequency drop by discharge temperature protection	Temperature of discharge temperature thermistor exceeds 232°F (111°C), compressor frequency lowers.		•Check refrigerant circuit and refrigerant amount. •Refer to 10-5.Ⓚ "Check of LEV". •Refer to 10-5.Ⓢ "Check of outdoor thermistors".
19		MUFZ-KJ09/12 5-time flash 2.5 seconds OFF	Outside temperature thermistor protection	When the outside temperature thermistor shorts or opens, protective operation without that thermistor is performed.		•Refer to 10-5.Ⓢ Check of outdoor thermistors.
20	Outdoor unit operates.	7-time flash 2.5 seconds OFF	Low discharge temperature protection	Temperature of discharge temperature thermistor has been 122°F (50°C) or less for 20 minutes.		•Refer to 10-5.Ⓚ "Check of LEV". •Check refrigerant circuit and refrigerant amount.
21		8-time flash 2.5 seconds OFF	MUFZ-KJ09/12 PAM protection PAM: Pulse Amplitude Modulation	The overcurrent flows into PFC (Power factor correction :C820) or the DC voltage reaches 394 V or more, PAM stops and restarts.		This is not malfunction. PAM protection will be activated in the following cases: 1 Instantaneous power voltage drop. (Short time power failure) 2 When the power supply voltage is high.
			MUFZ-KJ15/18 Zero cross detecting circuit	Zero cross signal cannot be detected.		•It occurs with following cases. 1 Instantaneous power voltage drop. (Short time power failure) 2 Distortion of primary voltage •Refer to 10-5.Ⓢ "Check of power supply".
22		9-time flash 2.5 seconds OFF	Inverter check mode	The connector of compressor is disconnected, inverter check mode starts.		•Check if the connector of the compressor is correctly connected. Refer to 10-5.Ⓢ "How to check inverter/compressor".

NOTE: 1. The location of LED is illustrated at the right figure. Refer to 10-6.1.
2. LED is lighted during normal operation.

The flashing frequency shows the number of times the LED blinks after every 2.5-second OFF.
(Example) When the flashing frequency is "2".

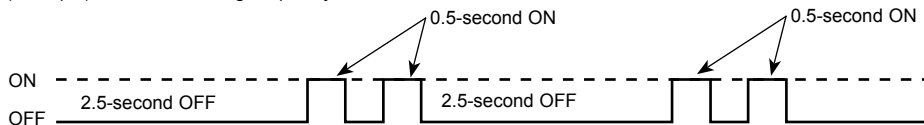

Inverter P.C. board
MUFZ-KJ09/12NAHZ

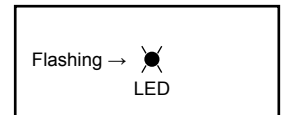

MUFZ-KJ15/18NAHZ

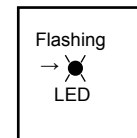

10-4. TROUBLE CRITERION OF MAIN PARTS

MUFZ-KJ09NAHZ MUFZ-KJ12NAHZ MUFZ-KJ15NAHZ MUFZ-KJ18NAHZ

Part name	Check method and criterion	Figure										
Defrost thermistor (RT61) Fin temperature thermistor (RT64) Ambient temperature thermistor (RT65) Outdoor heat exchanger temperature thermistor (RT68)	Measure the resistance with a tester. Refer to 10-6. "Test point diagram and voltage", 1. "Inverter P.C. board", for the chart of thermistor.											
Discharge temperature thermistor (RT62)	Measure the resistance with a tester. Before measurement, hold the thermistor with your hands to warm it up. Refer to 10-6. "Test point diagram and voltage", 1. "Inverter P.C. board", for the chart of thermistor.											
Compressor	Measure the resistance between terminals using a tester. [Temperature: 14 - 104°F (-10 - 40°C)] <table border="1"> <thead> <tr> <th rowspan="2"></th> <th colspan="2">Normal (Ω)</th> </tr> <tr> <th>MUFZ-KJ09/12</th> <th>MUFZ-KJ15/18</th> </tr> </thead> <tbody> <tr> <td>U-V</td> <td rowspan="3">1.66 - 2.26</td> <td rowspan="3">0.87 - 1.18</td> </tr> <tr> <td>U-W</td> </tr> <tr> <td>V-W</td> </tr> </tbody> </table>		Normal (Ω)		MUFZ-KJ09/12	MUFZ-KJ15/18	U-V	1.66 - 2.26	0.87 - 1.18	U-W	V-W	
	Normal (Ω)											
	MUFZ-KJ09/12	MUFZ-KJ15/18										
U-V	1.66 - 2.26	0.87 - 1.18										
U-W												
V-W												
Outdoor fan motor	Measure the resistance between lead wires using a tester. [Temperature: 14 - 104°F (-10 - 40°C)] <table border="1"> <thead> <tr> <th rowspan="2">Color of lead wire</th> <th colspan="2">Normal (Ω)</th> </tr> <tr> <th>MUFZ-KJ09/12</th> <th>MUFZ-KJ15/18</th> </tr> </thead> <tbody> <tr> <td>RED - BLK</td> <td rowspan="3">29 - 40</td> <td rowspan="3">12 - 16</td> </tr> <tr> <td>BLK - WHT</td> </tr> <tr> <td>WHT - RED</td> </tr> </tbody> </table>	Color of lead wire	Normal (Ω)		MUFZ-KJ09/12	MUFZ-KJ15/18	RED - BLK	29 - 40	12 - 16	BLK - WHT	WHT - RED	
Color of lead wire	Normal (Ω)											
	MUFZ-KJ09/12	MUFZ-KJ15/18										
RED - BLK	29 - 40	12 - 16										
BLK - WHT												
WHT - RED												
R. V. coil (21S4)	Measure the resistance using a tester. [Temperature: 14 - 104°F (-10 - 40°C)] <table border="1"> <thead> <tr> <th>Normal (kΩ)</th> </tr> </thead> <tbody> <tr> <td>0.97 - 1.38</td> </tr> </tbody> </table>	Normal (kΩ)	0.97 - 1.38									
Normal (kΩ)												
0.97 - 1.38												
Expansion valve coil (LEV)	Measure the resistance using a tester. [Temperature: 14 - 104°F (-10 - 40°C)] <table border="1"> <thead> <tr> <th>Color of lead wire</th> <th>Normal (Ω)</th> </tr> </thead> <tbody> <tr> <td>RED - ORN</td> <td rowspan="4">37 - 54</td> </tr> <tr> <td>RED - WHT</td> </tr> <tr> <td>RED - BLU</td> </tr> <tr> <td>RED - YLW</td> </tr> </tbody> </table>	Color of lead wire	Normal (Ω)	RED - ORN	37 - 54	RED - WHT	RED - BLU	RED - YLW				
Color of lead wire	Normal (Ω)											
RED - ORN	37 - 54											
RED - WHT												
RED - BLU												
RED - YLW												
Defrost heater	Measure the resistance using a tester. [Temperature: 14 - 104°F (-10 - 40°C)] <table border="1"> <thead> <tr> <th colspan="2">Normal (Ω)</th> </tr> <tr> <th>MUFZ-KJ09/12NAHZ</th> <th>MUFZ-KJ15/18NAHZ</th> </tr> </thead> <tbody> <tr> <td>349 - 428</td> <td>376 - 461</td> </tr> </tbody> </table>	Normal (Ω)		MUFZ-KJ09/12NAHZ	MUFZ-KJ15/18NAHZ	349 - 428	376 - 461					
Normal (Ω)												
MUFZ-KJ09/12NAHZ	MUFZ-KJ15/18NAHZ											
349 - 428	376 - 461											

10-5. TROUBLESHOOTING FLOW

A How to check inverter/compressor

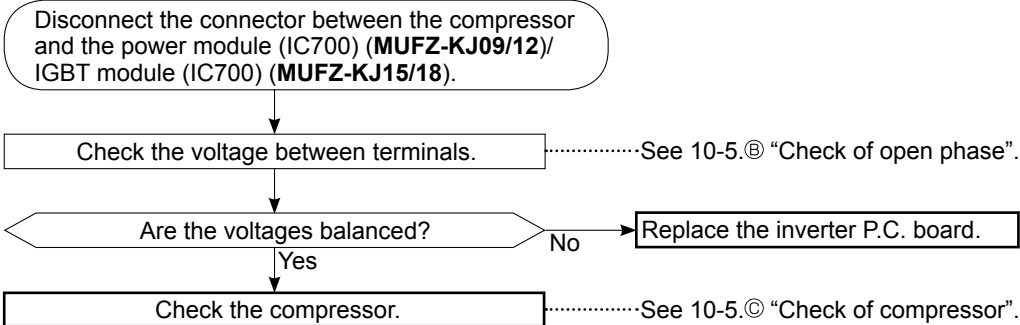

B Check of open phase

- With the connector between the compressor and the power module (IC700) (MUFZ-KJ09/12)/IGBT module (IC700) (MUFZ-KJ15/18) disconnected, activate the inverter and check if the inverter is normal by measuring the **voltage balance** between the terminals.

Output voltage is 50 - 130 V. (The voltage may differ according to the tester.)

<< Operation method >>

Start cooling or heating operation by pressing EMERGENCY OPERATION switch on the indoor unit. (TEST RUN OPERATION: Refer to 7-6.)

<< Measurement point >>

At 3 points ※ Measure AC voltage between the lead wires at 3 points.

BLK (U)-WHT (V)
BLK (U)-RED (W)
WHT(V)-RED (W)

- NOTE:** 1. Output voltage varies according to power supply voltage.
2. Measure the voltage by analog type tester.
3. During this check, LED of the inverter P.C. board flashes 9 times. (Refer to 10-6.1.)

C Check of compressor

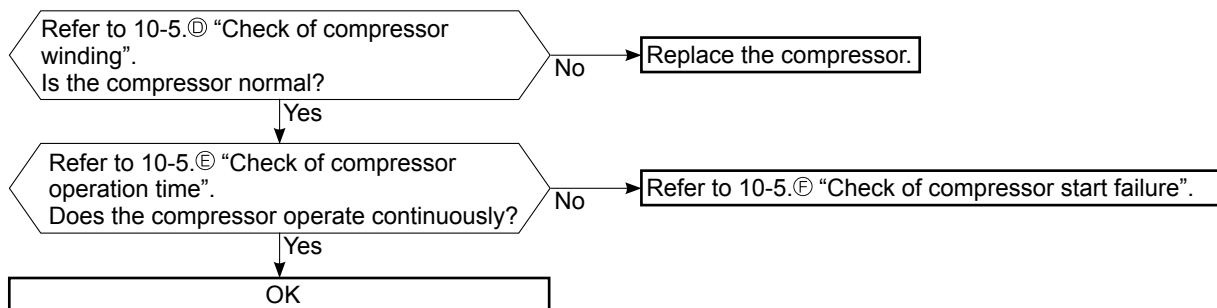

D Check of compressor winding

- Disconnect the connector between the compressor and the power module (IC700) (MUFZ-KJ09/12)/IGBT module (IC700) (MUFZ-KJ15/18), and measure the resistance between the compressor terminals.

<<Measurement point>>

At 3 points

BLK-WHT

BLK-RED

WHT-RED

※ Measure the resistance between the lead wires at 3 points.

<<Judgement>>

Refer to 10-4.

0 [Ω]Abnormal [short]

Infinite [Ω]Abnormal [open]

NOTE: Be sure to zero the ohmmeter before measurement.

E Check of compressor operation time

- Connect the compressor and activate the inverter. Then measure the time until the inverter stops due to overcurrent.

<<Operation method>>

Start heating or cooling operation by pressing EMERGENCY OPERATION switch on the indoor unit. (TEST RUN OPERATION: Refer to 7-6.)

<<Measurement>>

Measure the time from the start of compressor to the stop of compressor due to overcurrent.

<<Judgement>>

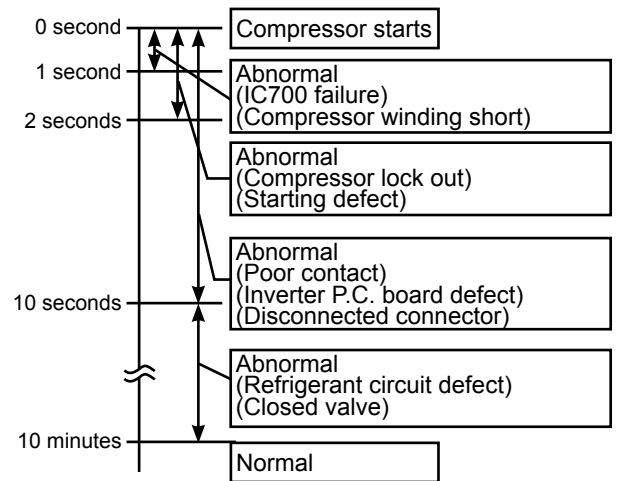

F Check of compressor start failure

Confirm that ①~④ is normal.

•Electrical circuit check

①. Contact of the compressor connector

②. Output voltage of inverter P.C. board and balance of them (See 10-5.⑥)

③. Direct current voltage between DB61(+) and (-) (MUFZ-KJ09/12)/JP715(+) and JP30(-) (MUFZ-KJ15/18) on the inverter P.C. board

④. Voltage between outdoor terminal block S1-S2

Does the compressor run for 10 seconds or more after it starts?

Yes

Check the refrigerant circuit.
Check the stop valve.

No

After the compressor is heated with a drier, does the compressor start? ※1

No

Replace the compressor.

Yes

Compressor start failure. Activate pre-heat control. (Refer to 9-2. "PRE-HEAT CONTROL SETTING")

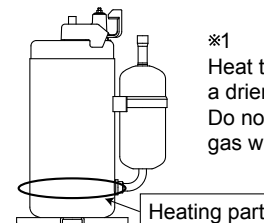

※1
Heat the compressor with a drier for about 20 minutes. Do not recover refrigerant gas while heating.

Ⓒ Check of outdoor thermistors

Disconnect the connector of thermistor in the inverter P.C. board (see below table), and measure the resistance of thermistor.

Is the resistance of thermistor normal?
(Refer to 10-6.1.)

No

Replace the thermistor except RT64.
When RT64 is abnormal, replace the inverter P.C. board.

Yes

Reconnect the connector of thermistor.
Turn ON the power supply and press EMERGENCY OPERATION switch.

Does the unit operate for 10 minutes or more
without showing thermistor abnormality?

No

Replace the inverter P.C. board.

Yes

OK
(Cause is poor contact.)

MUFZ-KJ09/12

Thermistor	Symbol	Connector, Pin No.	Board
Defrost	RT61	Between CN641 pin1 and pin2	Inverter P.C. board
Discharge temperature	RT62	Between CN641 pin3 and pin4	
Fin temperature	RT64	Between CN642 pin1 and pin2	
Ambient temperature	RT65	Between CN643 pin1 and pin2	
Outdoor heat exchanger temperature	RT68	Between CN644 pin1 and pin3	

MUFZ-KJ15/18

Thermistor	Symbol	Connector, Pin No.	Board
Defrost	RT61	Between CN671 pin1 and pin2	Inverter P.C. board
Discharge temperature	RT62	Between CN671 pin3 and pin4	
Fin temperature	RT64	Between CN673 pin1 and pin2	
Ambient temperature	RT65	Between CN672 pin1 and pin2	
Outdoor heat exchanger temperature	RT68	Between CN671 pin5 and pin6	

H Check of R.V. coil

MUFZ-KJ09/12

- ※ First of all, measure the resistance of R.V. coil to check if the coil is defective. Refer to 10-4.
- ※ In case CN721 is disconnected or R.V. coil is open, voltage is generated between the terminal pins of the connector although no signal is being transmitted to R.V. coil.
Check if CN721 is connected.

Unit operates COOL mode even if it is set to HEAT mode.

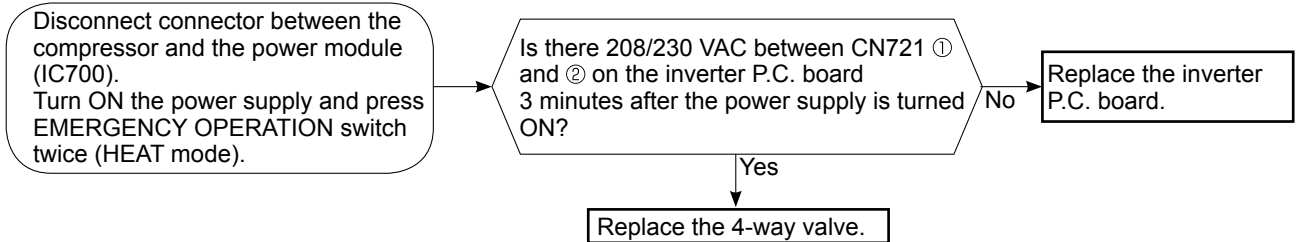

Unit operates HEAT mode even if it is set to COOL mode.

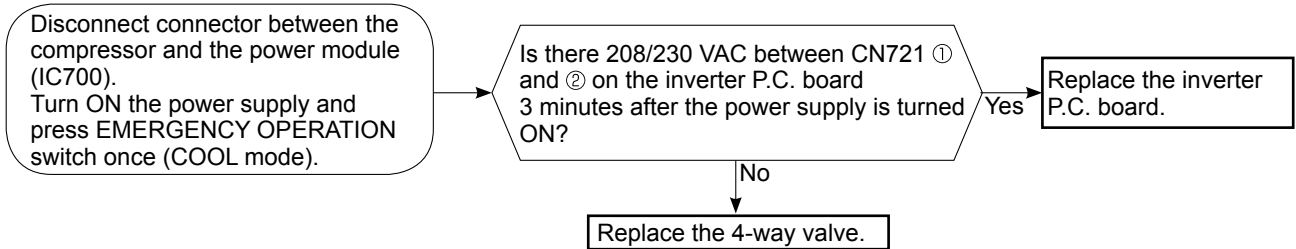

MUFZ-KJ15/18

- ※ First of all, measure the resistance of R.V. coil to check if the coil is defective. Refer to 10-4.
- ※ In case CN602 is disconnected or R.V. coil is open, voltage is generated between the terminal pins of the connector although no signal is being transmitted to R.V. coil.
Check if CN602 is connected.

Unit operates COOL mode even if it is set to HEAT mode.

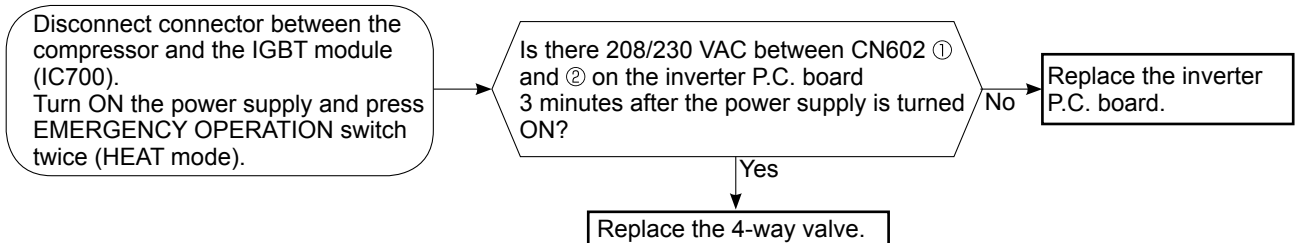

Unit operates HEAT mode even if it is set to COOL mode.

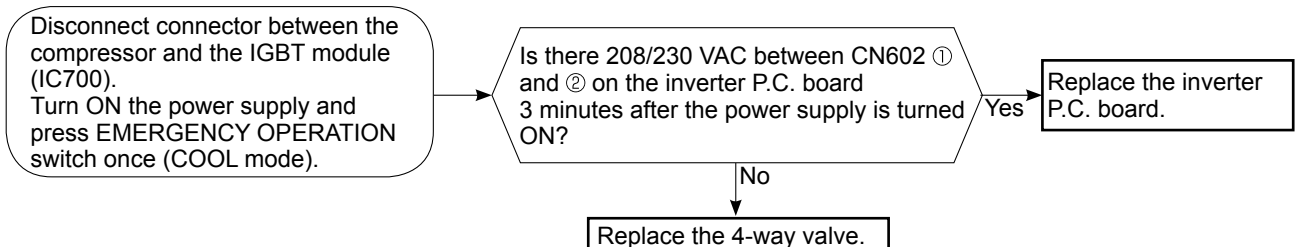

① Check of outdoor fan motor

Disconnect the connectors CN931 and CN932 from the inverter P.C. board.
Check the connection between the connector CN931 and CN932.

Is the resistance between each terminal of outdoor fan motor normal?
(Refer to 10-4.)

Yes

Disconnect CN932 from the inverter P.C. board, and turn on the power supply.

Rotate the outdoor fan motor manually and measure the voltage of CN931.
Between 1(+) and 5(-)
Between 2(+) and 5(-)
Between 3(+) and 5(-)

(Fixed to either 5 or 0 VDC)
Does the voltage between each terminal become 5 and 0 VDC repeatedly?

No

Yes

Does the outdoor fan motor rotate smoothly?

No

Yes

Replace the outdoor fan motor.

Replace the inverter P.C. board.

J Check of power supply

Disconnect the connector between the compressor and the power module (IC700) (MUFZ-KJ09/12)/IGBT module (IC700) (MUFZ-KJ15/18). Turn ON power supply and press EMERGENCY OPERATION switch.

Does the left lamp of the OPERATION INDICATOR lamp on the indoor unit light up?

No

Is there voltage 208/230 VAC between the indoor terminal block S1 and S2?

No

Replace the indoor electronic control P.C. board.

Rectify indoor/outdoor connecting wire.

Yes

Is there DC voltage 260 - 370 VDC between DB61 (+) and DB61 (-) (MUFZ-KJ09/12)/294 - 370 VDC between JP715 (+) and JP30 (-) (MUFZ-KJ15/18) on the inverter P.C. board? (Refer to 10-6.1.)

Yes

Does LED on the inverter P.C. board light up or flash? (Refer to 10-6.1.)

No

Replace the inverter P.C. board.

Yes

If lights up, OK.
If flashes, refer to 10-3.

Check the electric parts in main circuit.

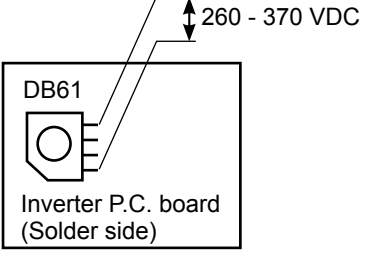

MUFZ-KJ09/12

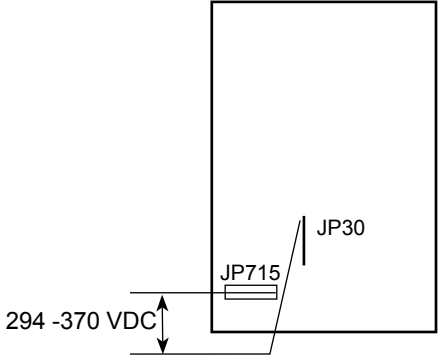

MUFZ-KJ15/18

K Check of LEV (Expansion valve)

Turn ON the power supply.

<Preparation of the remote controller>

- ① While pressing both OPERATION SELECT button and TEMP \oplus button on the remote controller at the same time, press RESET button.
- ② First, release RESET button.
Hold down the other 2 buttons for another 3 seconds.
Make sure that the indicators on the LCD screen shown in the right figure are all displayed. Then release the buttons.

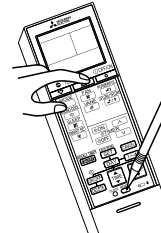

Press STOP/OPERATE (OFF/ON) button of the remote controller (the set temperature is displayed) with the remote controller headed towards the indoor unit. ※1

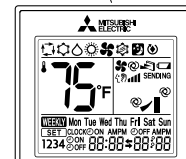

Expansion valve operates in full-opening direction.

Do you hear the expansion valve "click, click....." ?
Do you feel the expansion valve vibrate when touching it ?

Yes → OK

No

Is LEV coil properly fixed to the expansion valve?

No

Properly fix the LEV coil to the expansion valve.

Yes

Does the resistance of LEV coil have the characteristics? (Refer to 10-4.)

Yes

Measure each voltage between connector pins of CN724 on the inverter P.C. board.

1. Pin③(-) — Pin①(+)
2. Pin④(-) — Pin①(+)
3. Pin⑤(-) — Pin①(+)
4. Pin⑥(-) — Pin①(+)

Is there about 3 - 5 VAC between each?
NOTE: Measure the voltage by an analog tester.

No → Replace the inverter P.C. board.

Yes

Replace the expansion valve.

※1. Regardless of normal or abnormal condition, a short beep is emitted once the signal is received.

NOTE: After check of LEV, do the undermentioned operations.

1. Turn OFF the power supply and turn it ON again.
2. Press RESET button on the remote controller.

L Check of inverter P.C. board

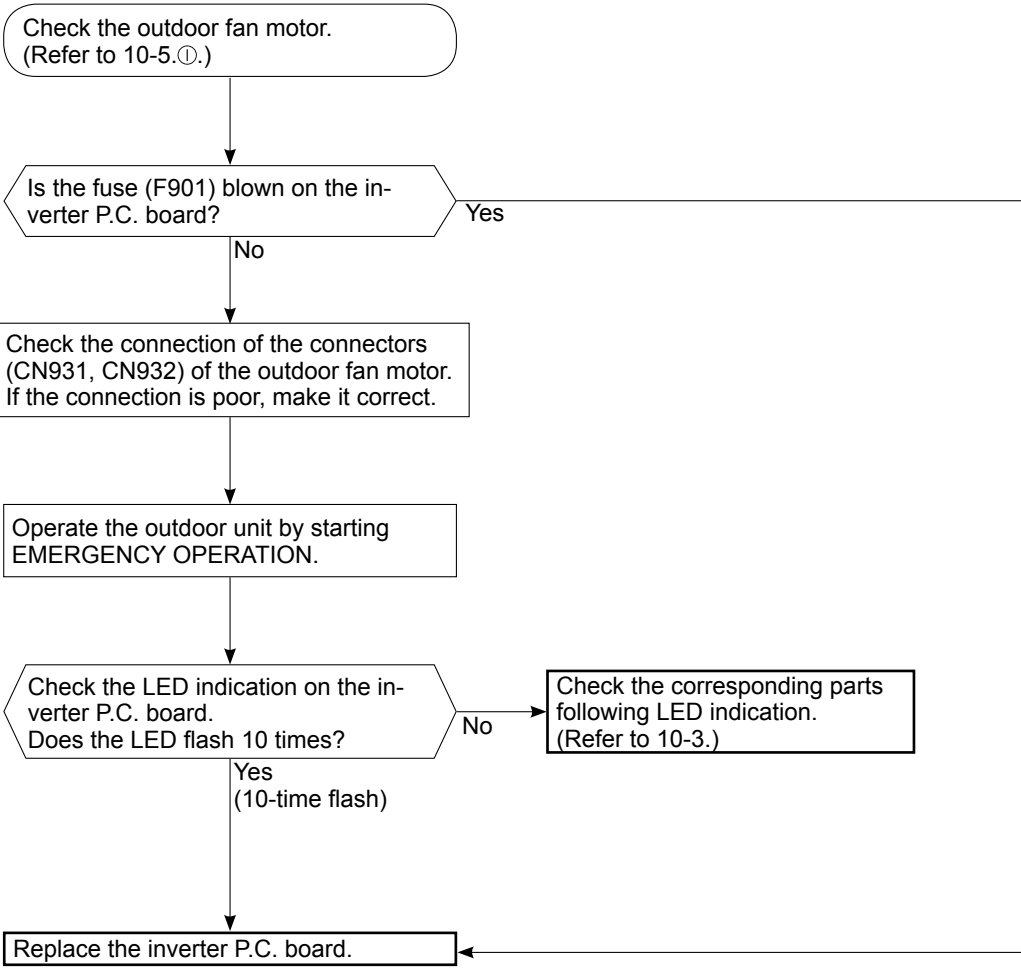

M How to check miswiring and serial signal error

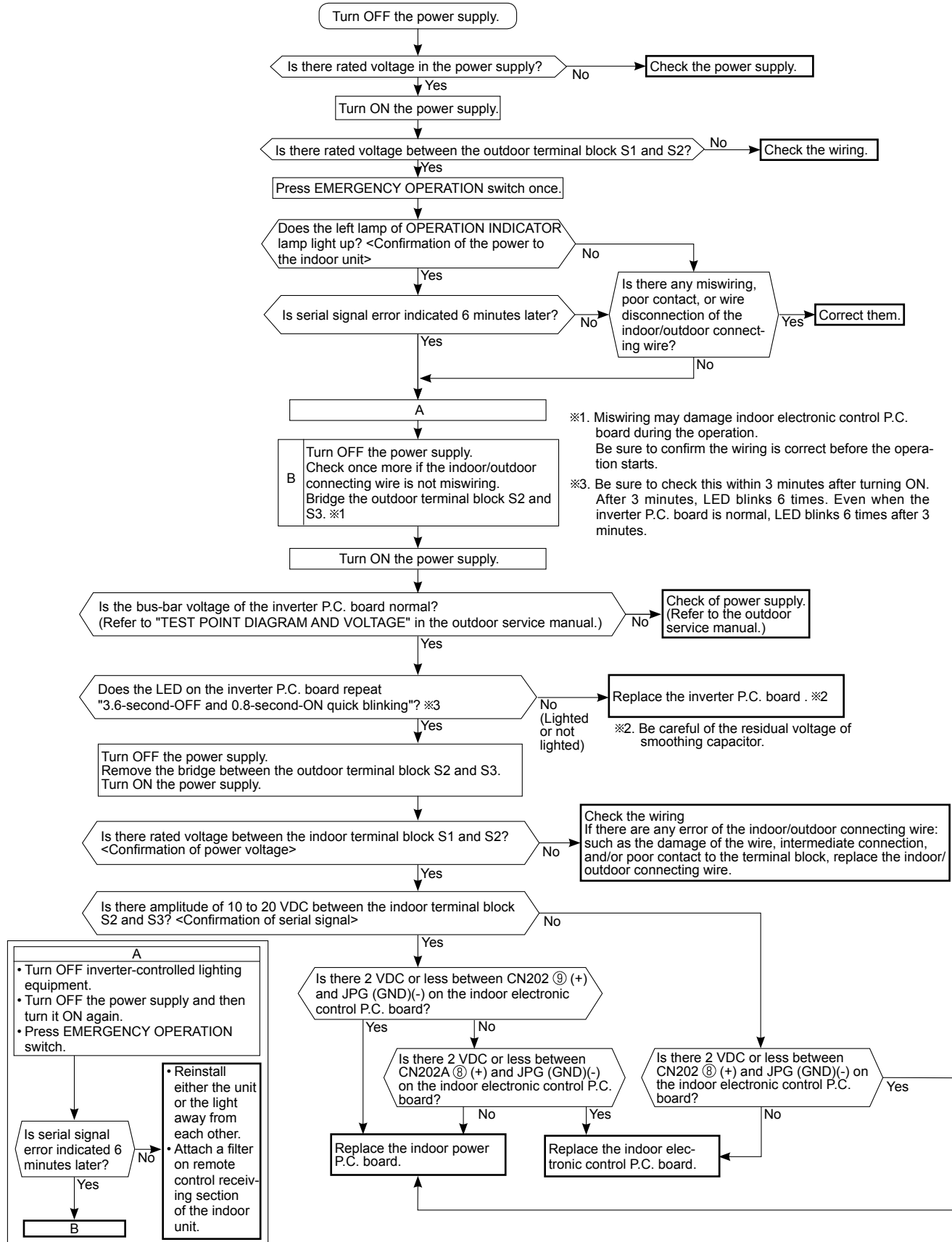

N Check of defrost heater

MUFZ-KJ09NAHZ MUFZ-KJ12NAHZ MUFZ-KJ15NAHZ MUFZ-KJ18NAHZ

Check the following points before checking electric continuity.

1. Does the resistance of ambient temperature thermistor have the characteristics? Refer to 10-6.1.
2. Is the resistance of defrost heater normal? Refer to 10-4.
3. Does the heater protector remain conducted (not open)?
4. Are both ambient temperature thermistor and circuit of defrost heater securely connected to connectors?

In HEAT mode, for more than 5 minutes, let the ambient temperature thermistor continue to read 32°F (0°C) or below, and let the defrost thermistor continue to read 30°F (-1°C) or below.

NOTE: In case both thermistors are more than the above temperature, cool them with cold water etc...

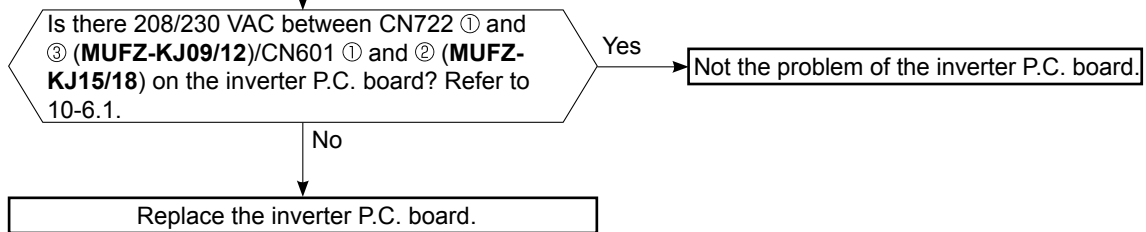

O Check of outdoor refrigerant circuit

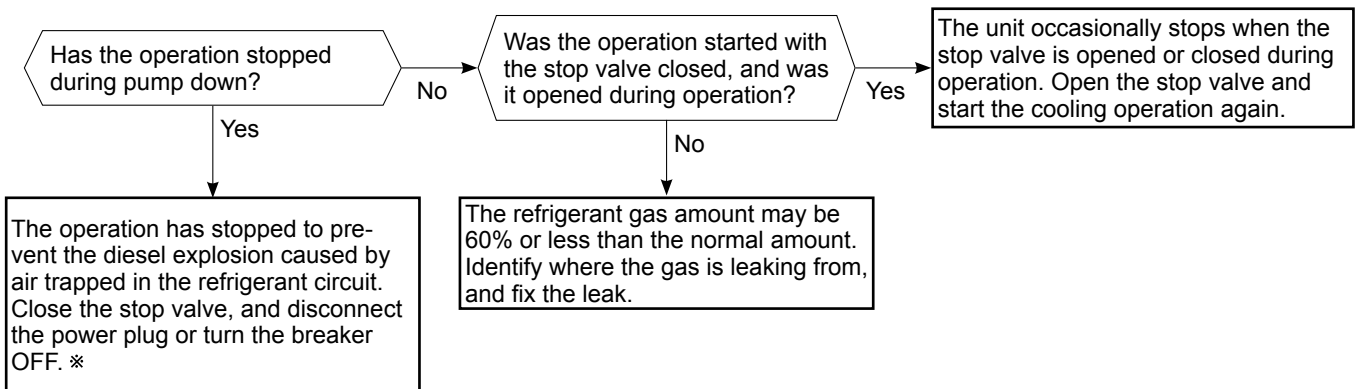

* **CAUTION** : Do not start the operation again to prevent hazards.

P Electromagnetic noise enters into TV sets or radios

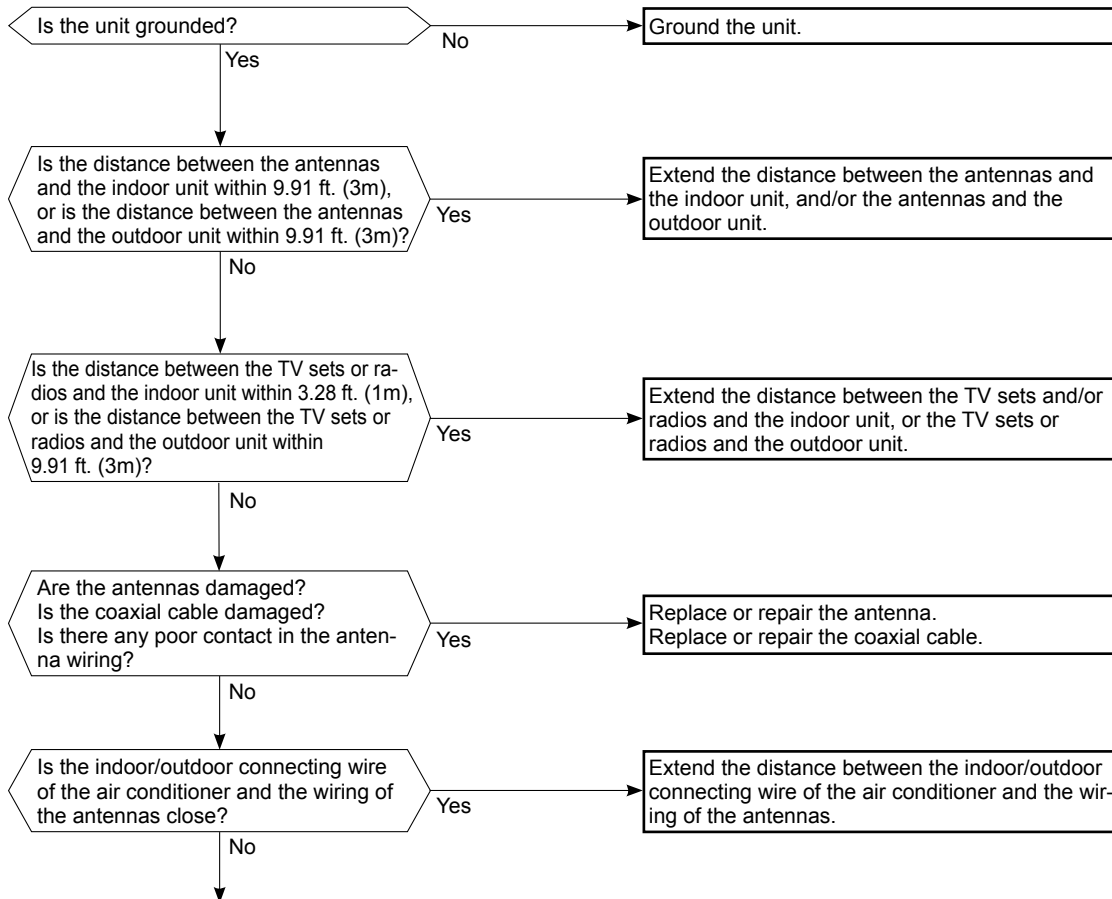

Even if all of the above conditions are fulfilled, the electromagnetic noise may enter, depending on the electric field strength or the installation condition (combination of specific conditions such as antennas or wiring).

Check the following before asking for service.

1. Devices affected by the electromagnetic noise
TV sets, radios (FM/AM broadcast, shortwave)
2. Channel, frequency, broadcast station affected by the electromagnetic noise
3. Channel, frequency, broadcast station unaffected by the electromagnetic noise
4. Layout of:
indoor/outdoor unit of the air conditioner, indoor/outdoor wiring, ground wire, antennas, wiring from antennas, receiver
5. Electric field intensity of the broadcast station affected by the electromagnetic noise
6. Presence or absence of amplifier such as booster
7. Operation condition of air conditioner when the electromagnetic noise enters in
 - 1) Turn OFF the power supply once, and then turn ON the power supply. In this situation, check for the electromagnetic noise.
 - 2) Within 3 minutes after turning ON the power supply, press STOP/OPERATE (OFF/ON) button on the remote controller for power ON, and check for the electromagnetic noise.
 - 3) After a short time (3 minutes later after turning ON), the outdoor unit starts running. During operation, check for the electromagnetic noise.
 - 4) Press STOP/OPERATE (OFF/ON) button on the remote controller for power OFF, when the outdoor unit stops but the indoor/outdoor communication still runs on. In this situation, check for the electromagnetic noise.

10-6. TEST POINT DIAGRAM AND VOLTAGE

1. Inverter P.C. board

MUFZ-KJ09NAHZ MUFZ-KJ12NAHZ

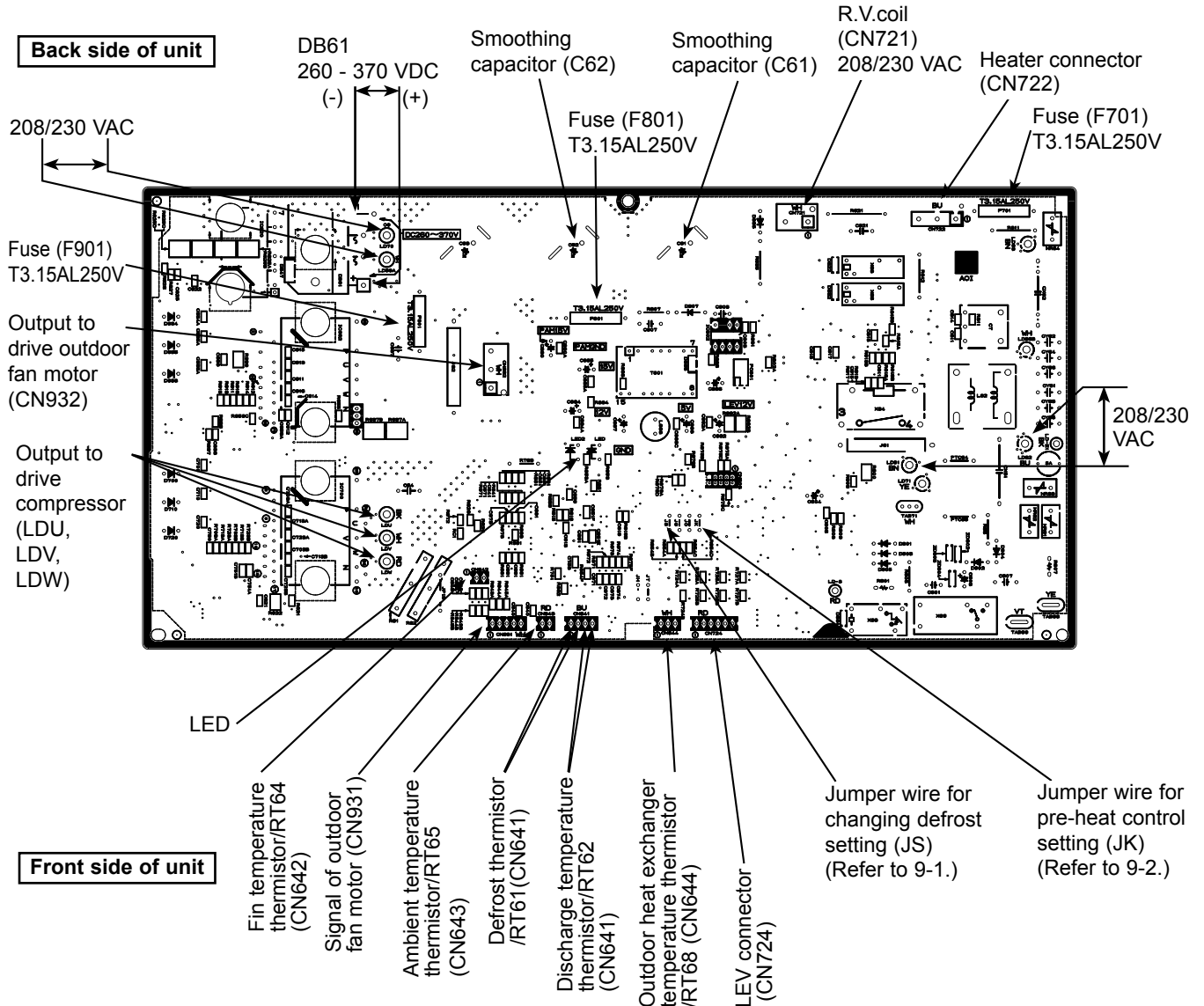

Defrost thermistor (RT61)
Ambient temperature thermistor (RT65)
Outdoor heat exchanger temperature thermistor (RT68)

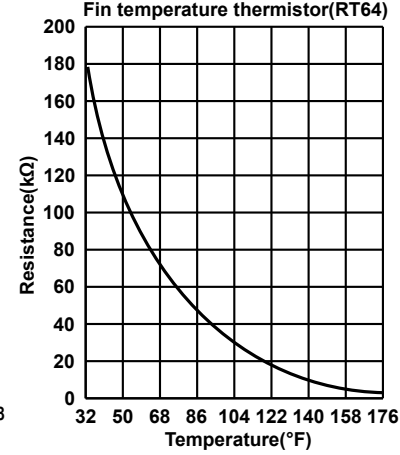
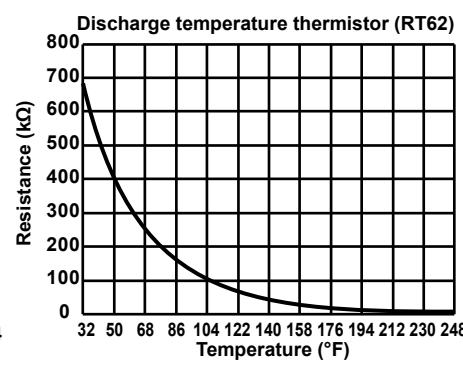
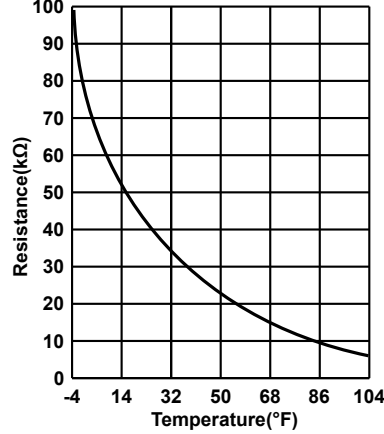

MUFZ-KJ15NAHZ
MUFZ-KJ18NAHZ

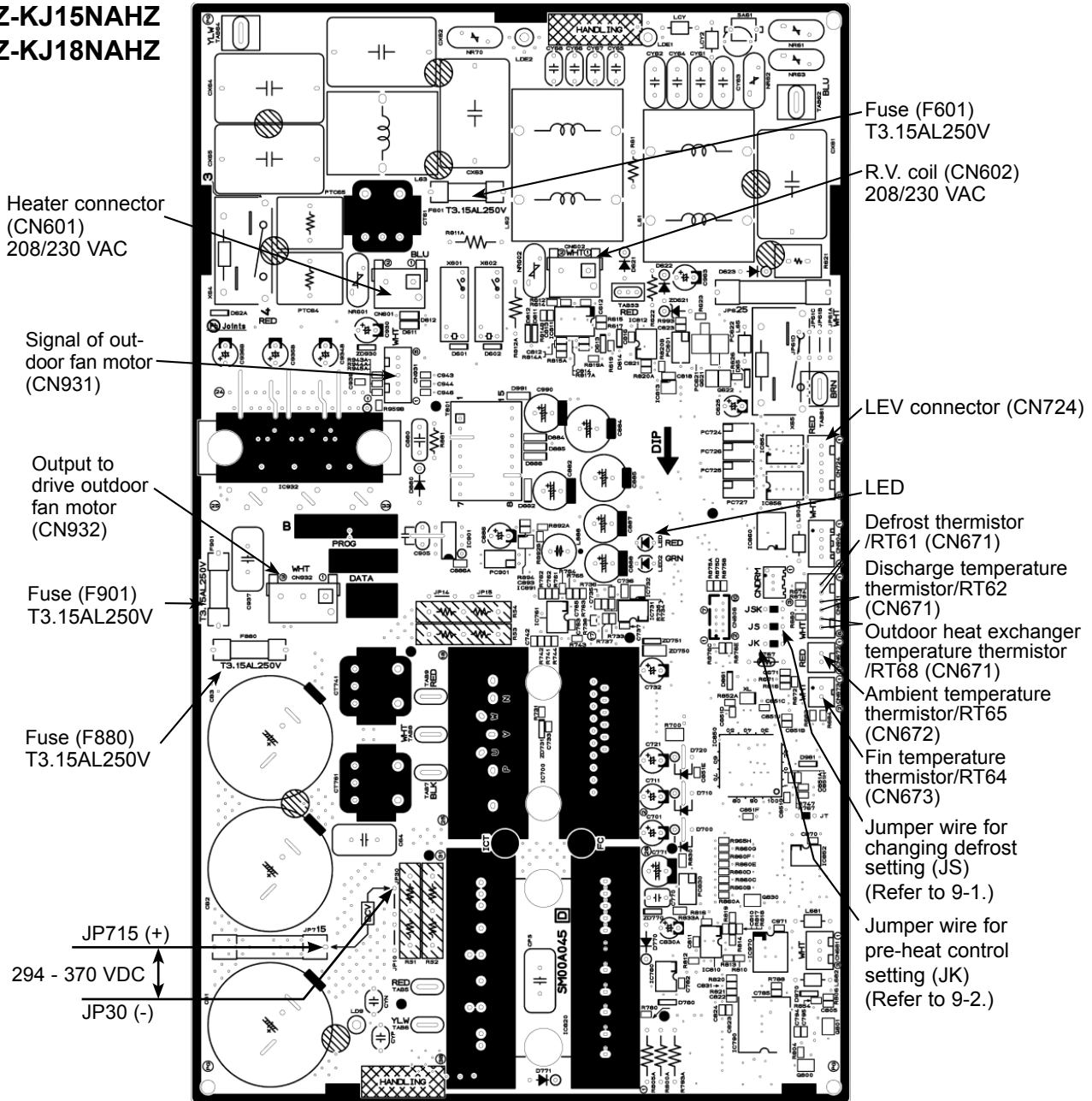

Defrost thermistor(RT61)
Ambient temperature thermistor(RT65)
Outdoor heat exchanger temperature thermistor(RT68)

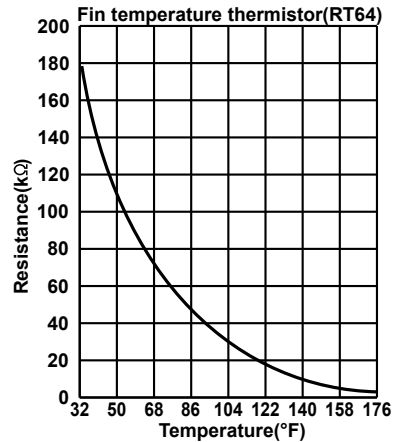
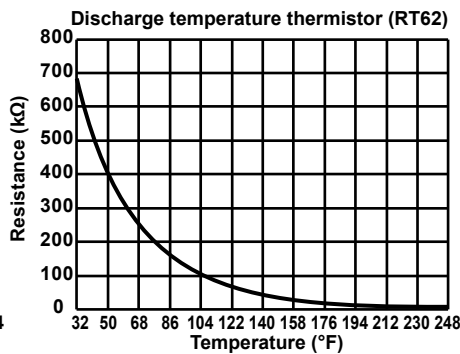
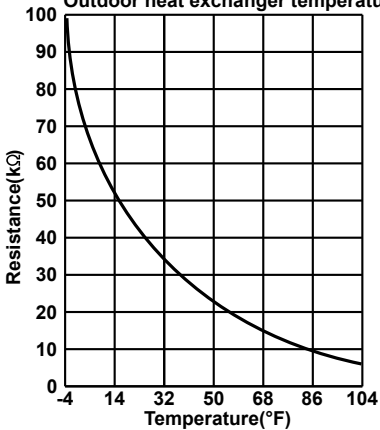

<"Terminal with locking mechanism" Detaching points>

The terminal which has the locking mechanism can be detached as shown below.
 There are 2 types (refer to (1) and (2)) of the terminal with locking mechanism.
 The terminal without locking mechanism can be detached by pulling it out.
 Check the shape of the terminal before detaching.

(1) Slide the sleeve and check if there is a locking lever or not.

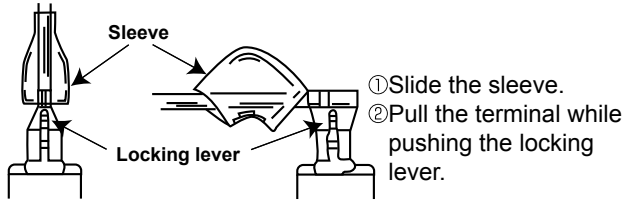

(2) The terminal with this connector has the locking mechanism.

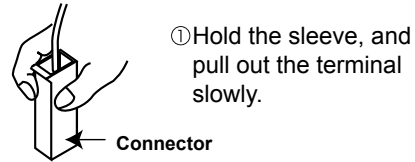

11-1. MUFZ-KJ09NAHZ MUFZ-KJ12NAHZ

NOTE: Turn OFF the power supply before disassembly.

OPERATING PROCEDURE	PHOTOS
<p>1. Removing the cabinet</p> <ol style="list-style-type: none"> (1) Remove the screw fixing the service panel. (2) Pull down the service panel and remove it. (3) Remove the screws fixing the conduit cover. (4) Remove the conduit cover. (Photo 4) (5) Remove the screw fixing the conduit plate. (Photo 5) (6) Remove the conduit plate. (7) Disconnect the power supply wire and indoor/outdoor connecting wire. (8) Remove the screws fixing the top panel. (9) Remove the top panel. (10) Remove the screws fixing the cabinet. (11) Remove the cabinet. (12) Remove the screws fixing the back panel. (13) Remove the back panel. <p>Photo 2</p>	<p>Photo 1</p> <p>Photo 3</p>

OPERATING PROCEDURE

Photo 4

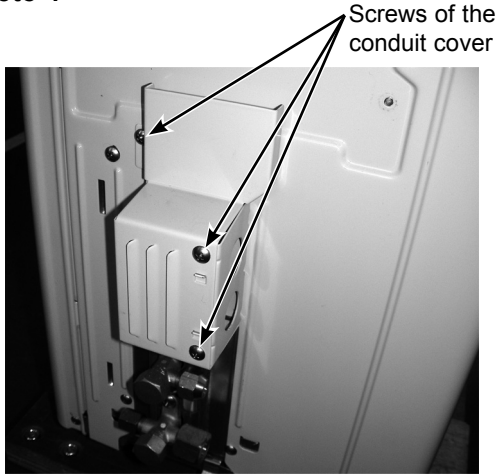

PHOTOS

Photo 5

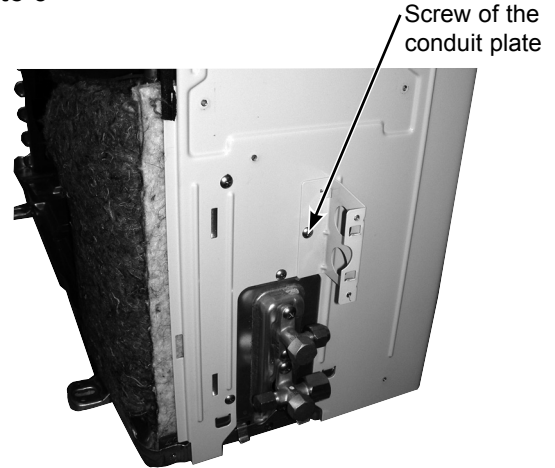

2. Removing the inverter assembly, inverter P.C. board

- (1) Remove the cabinet and panels. (Refer to 1.)
- (2) Disconnect the lead wire to the reactor and the following connectors:
<Inverter P.C. board>
CN721 (R.V. coil)
CN722 (Defrost heater and heater protector)
CN931, CN932 (Fan motor)
CN641 (Defrost thermistor and discharge temperature thermistor)
CN643 (Ambient temperature thermistor)
CN644 (Outdoor heat exchanger temperature thermistor)
CN724 (LEV)
- (3) Remove the compressor connector (CN61).
- (4) Remove the screws fixing the heat sink support and the separator.
- (5) Remove the fixing screws of the terminal block support and the back panel.
- (6) Remove the inverter assembly.
- (7) Remove the screw of the ground wire and screw of the terminal block support.
- (8) Remove the heat sink support from the P.C. board support.
- (9) Remove the screw of the inverter P.C. board and remove the inverter P.C. board from the P.C. board support.

Photo 6

Screws of the heat sink support and the separator

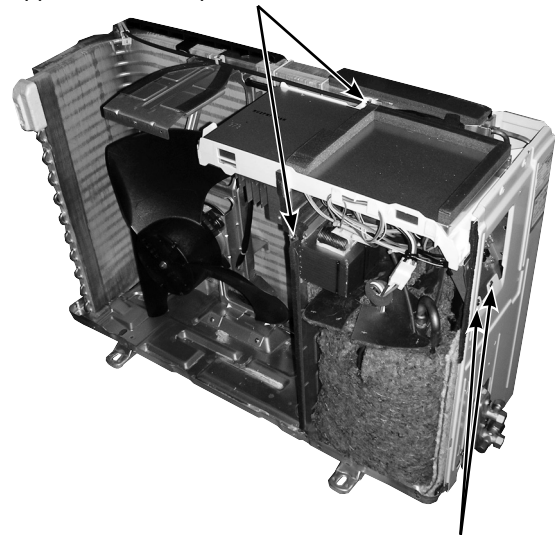

Screws of the terminal block support and the back panel

3. Removing R.V. coil

- (1) Remove the cabinet and panels. (Refer to 1.)
- (2) Disconnect the following connectors:
<Inverter P.C. board>
CN721 (R.V. coil)
- (3) Remove the R.V. coil.

Photo 7

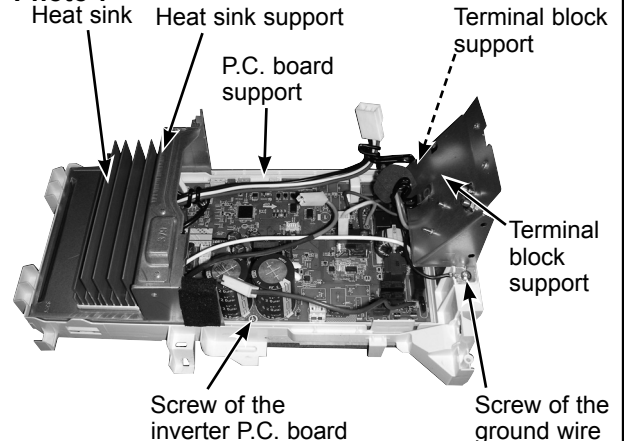

OPERATING PROCEDURE

4. Removing the discharge temperature thermistor, defrost thermistor, outdoor heat exchanger temperature thermistor and ambient temperature thermistor

- (1) Remove the cabinet and panels. (Refer to 1.)
- (2) Disconnect the lead wire to the reactor and the following connectors:
<Inverter P.C. board>
CN641 (Defrost thermistor and discharge temperature thermistor)
CN643 (Ambient temperature thermistor)
CN644 (Outdoor heat exchanger temperature thermistor)
- (3) Pull out the discharge temperature thermistor from its holder.
- (4) Pull out the defrost thermistor from its holder. (Photo 6)
- (5) Pull out the outdoor heat exchanger temperature thermistor from its holder. (Photo 6)
- (6) Pull out the ambient temperature thermistor from its holder.

PHOTOS

Photo 8

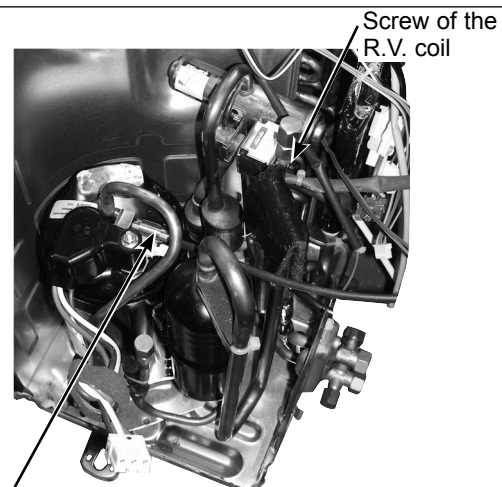

Discharge temperature thermistor

Photo 9

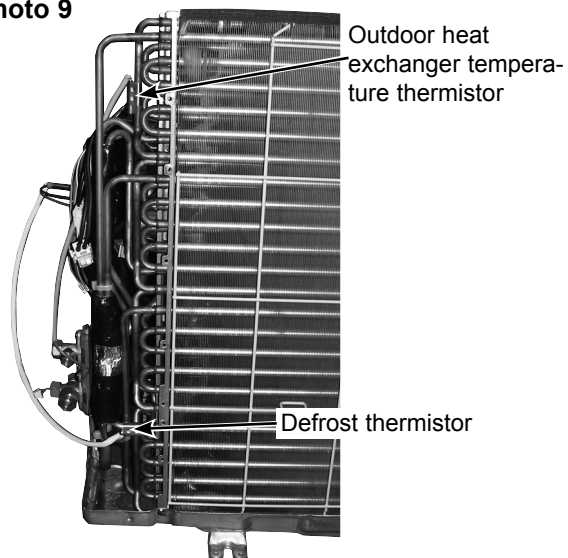
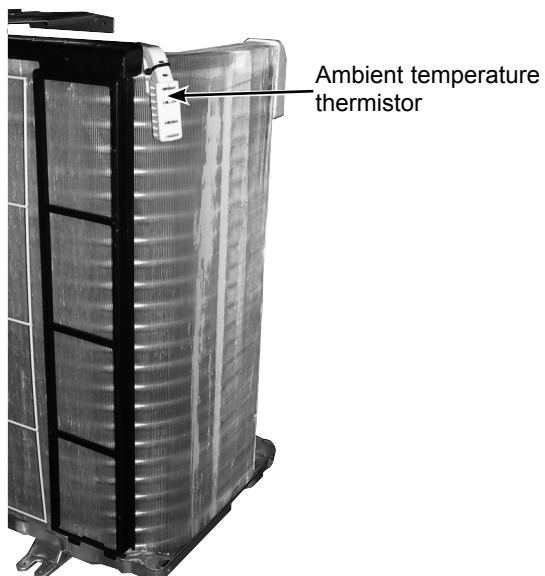

Photo 10



OPERATING PROCEDURE

5. Removing outdoor fan motor

- (1) Remove the cabinet and panels. (Refer to 1.)
- (2) Disconnect the following connectors:
<Inverter P.C. board>
CN931, CN932 (Fan motor)
- (3) Remove the propeller fan nut.
- (4) Remove the propeller fan.
- (5) Remove the screws fixing the fan motor.
- (6) Remove the fan motor.

NOTE: The propeller fan nut is a revers thread.

PHOTOS

Photo 11

Screws of the outdoor fan motor

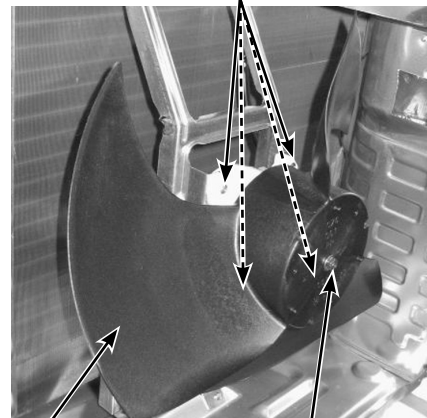

Propeller fan

Propeller fan nut

6. Removing the compressor and 4-way valve

- (1) Remove the cabinet and panels. (Refer to 1.)
- (2) Remove the inverter assembly. (Refer to 2.)
- (3) Remove the screws fixing the reactor.
- (4) Remove the reactor.
- (5) Remove the soundproof felt.
- (6) Recover gas from the refrigerant circuit.
NOTE: Recover gas from the pipes until the pressure gauge shows 0 PSIG.
- (7) Detach the brazed part of the suction and the discharge pipe connected with compressor.
- (8) Remove the nuts fixing the compressor.
- (9) Remove the compressor.
- (10) Detach the brazed part of pipes connected with 4-way valve.

Photo 12

Screws of the reactor



Soundproof felt

Suction pipe brazed part

Photo 13

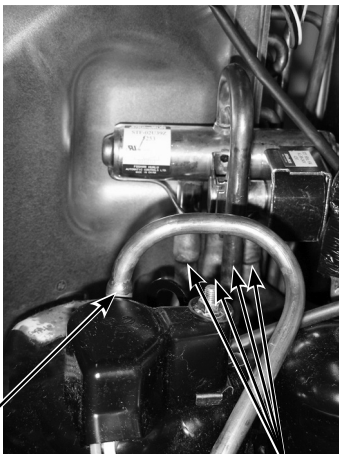





Discharge pipe brazed part

Brazed parts of 4-way valve

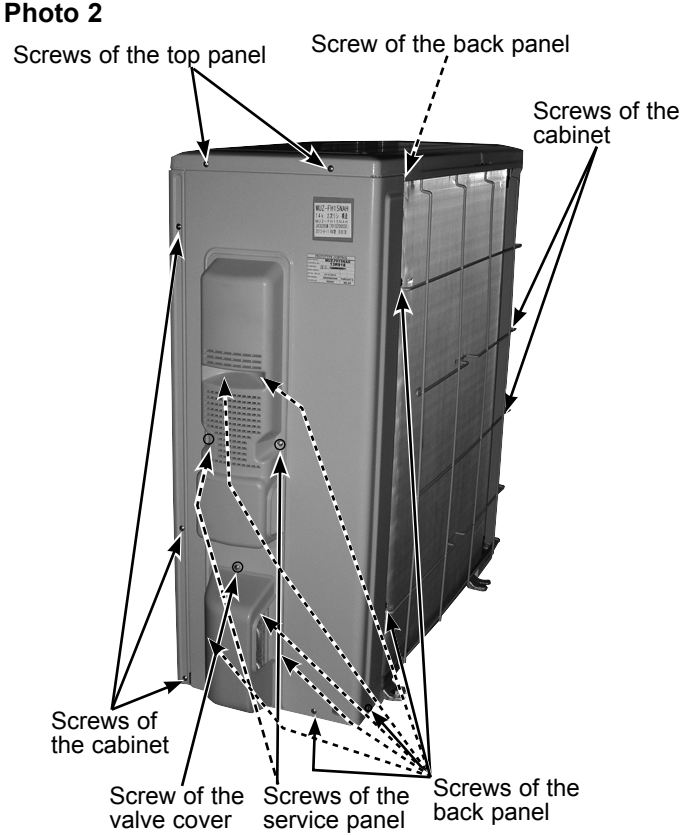
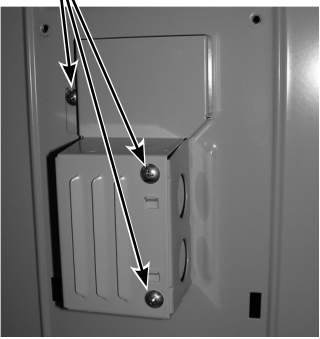
11-2. MUFZ-KJ15NAHZ MUFZ-KJ18NAHZ

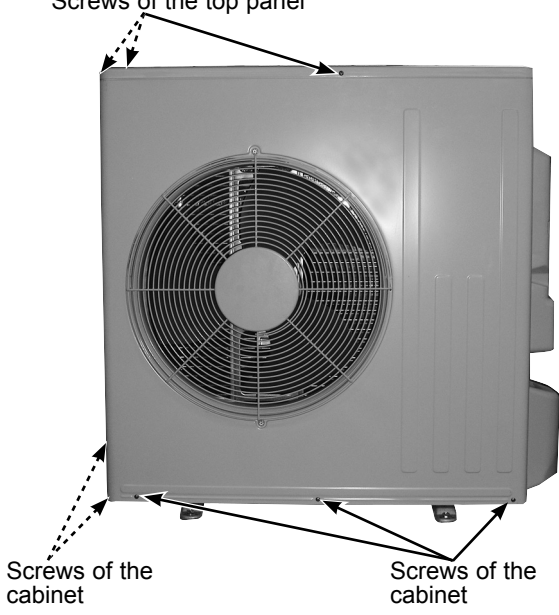
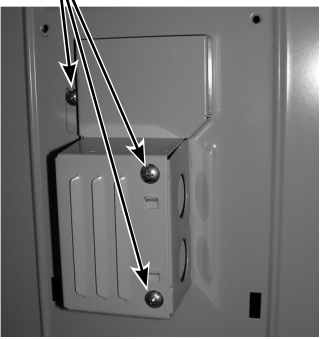
NOTE: Turn OFF the power supply before disassembly.

OPERATING PROCEDURE	PHOTOS
<p>1. Removing the cabinet</p> <ol style="list-style-type: none"> (1) Remove the screws of the service panel. (2) Remove the screws of the top panel. (3) Remove the screw of the valve cover. (4) Remove the service panel. (5) Remove the screws fixing the conduit cover. (6) Remove the conduit cover. (7) Remove the screw of fixing the conduit plate. (8) Remove the conduit plate. (9) Remove the top panel. (10) Remove the valve cover. (11) Disconnect the power supply and indoor/outdoor connecting wire. (12) Remove the screws of the cabinet. (13) Remove the cabinet. (14) Remove the screws of the back panel. (15) Remove the back panel. <p>Photo 2</p>  <p>Photo 3</p>  <p>Photo 4</p> 	<p>Photo 1</p>  <p>Photo 3</p>  <p>Photo 4</p> 

OPERATING PROCEDURE

2. Removing the inverter assembly, inverter P.C. board and relay P.C. board

- (1) Remove the cabinet and panels. (Refer to 1.)
- (2) Disconnect the lead wire to the reactor and the following connectors:
 - <Inverter P.C. board>
 - CN602 (R.V. coil)
 - CN931, CN932 (Fan motor)
 - CN671 (Defrost thermistor, discharge temperature thermistor and outdoor heat exchanger temperature thermistor)
 - CN672 (Ambient temperature thermistor)
 - CN724 (LEV)
 - CN601 (Defrost heater and heater protector)
- (3) Remove the compressor connector.
- (4) Remove the screws fixing the relay panel.
- (5) Remove the relay panel.
- (6) Remove the ground wires and the lead wires of the inverter P.C. board.
- (7) Remove the screws of the P.B. support.
- (8) Remove the inverter P.C. board from the P.B. support.

3. Removing R.V. coil

- (1) Remove the cabinet and panels. (Refer to 1.)
- (2) Disconnect the following connector:
 - <Inverter P.C. board>
 - CN602 (R.V. coil)
- (3) Remove the R.V. coil.

PHOTOS

Photo 5

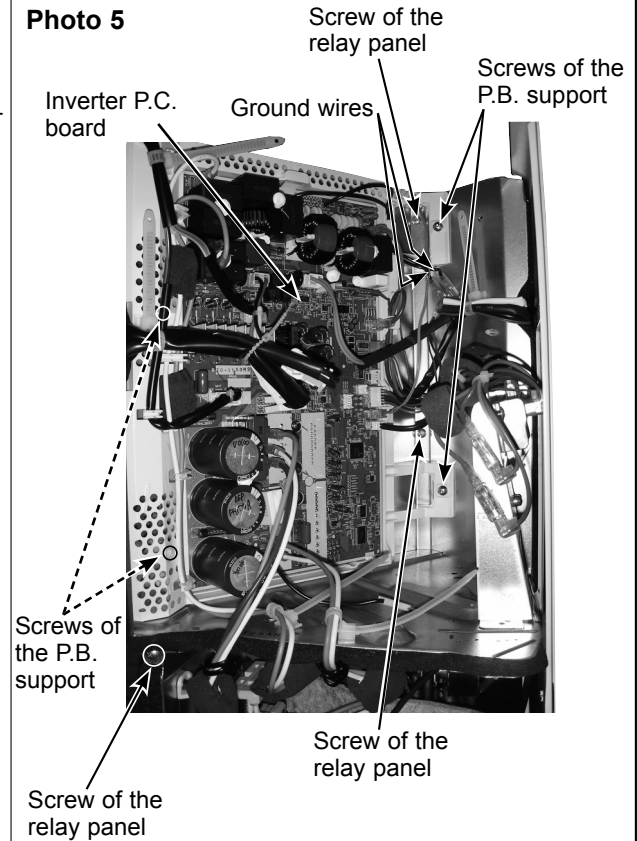

Photo 6



OPERATING PROCEDURE

4. Removing the discharge temperature thermistor, defrost thermistor, outdoor heat exchanger temperature thermistor and ambient temperature thermistor

- (1) Remove the cabinet and panels. (Refer to 1.)
- (2) Disconnect the lead wire to the reactor and the following connectors:
 - <Inverter P.C. board>
 - CN671 (Defrost thermistor, discharge temperature thermistor and outdoor heat exchanger temperature thermistor)
 - CN672 (Ambient temperature thermistor)
- (3) Pull out the discharge temperature thermistor from its holder.
- (4) Pull out the defrost thermistor from its holder.
- (5) Pull out the outdoor heat exchanger temperature thermistor from its holder.
- (6) Pull out the ambient temperature thermistor from its holder.

5. Removing outdoor fan motor

- (1) Remove the top panel, cabinet and service panel. (Refer to 1.)
- (2) Disconnect the following connectors:
 - <Inverter P.C. board>
 - CN931 and CN932 (Fan motor)
- (3) Remove the propeller fan.
- (4) Remove the screws fixing the fan motor.
- (5) Remove the fan motor.

NOTE: The propeller fan nut is a revers thread.

6. Removing the compressor and 4-way valve

- (1) Remove the top panel, cabinet and service panel. (Refer to 1.)
 - (2) Remove the back panel. (Refer to 1.)
 - (3) Remove the inverter assembly. (Refer to 2.)
 - (4) Remove the soundproof felt.
 - (5) Recover gas from the refrigerant circuit.
- NOTE:** Recover gas from the pipes until the pressure gauge shows 0 PSIG.
- (6) Detach the brazed part of the suction and the discharge pipe connected with compressor.
 - (7) Remove the nuts fixing the compressor.
 - (8) Remove the compressor.
 - (9) Detach the brazed parts of 4-way valve and pipe. (Photo 4)

PHOTOS

Photo 7

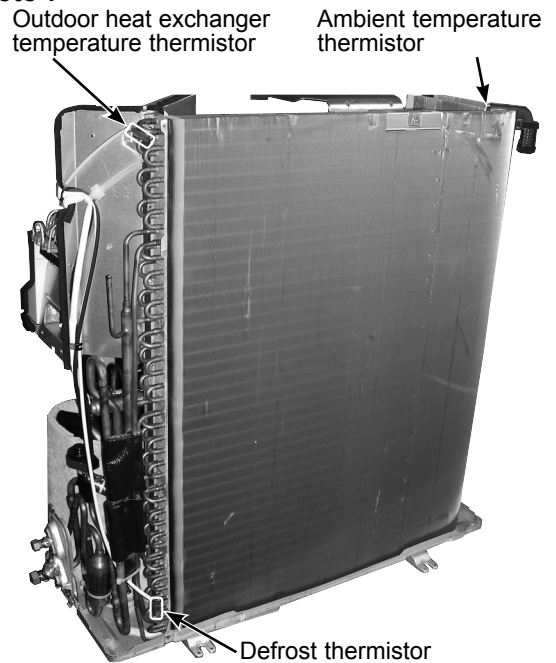

Photo 8

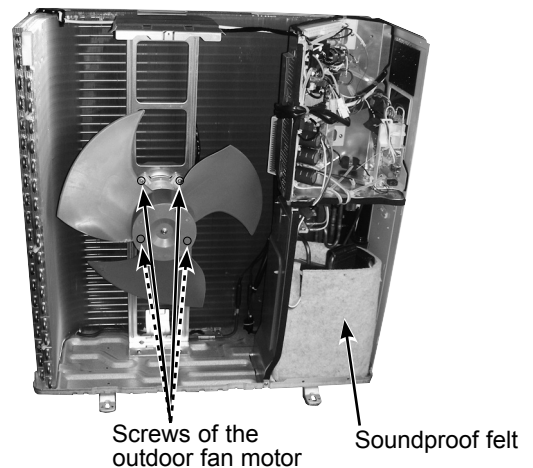
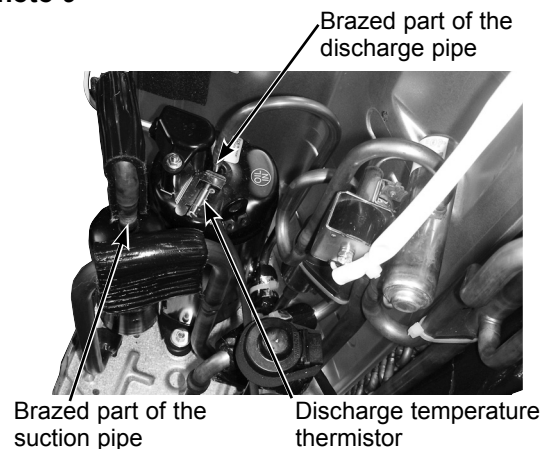

Photo 9



mitsubishi electric corporation

HEAD OFFICE: TOKYO BLDG., 2-7-3, MARUNOUCHI, CHIYODA-KU, TOKYO 100-8310, JAPAN

© Copyright 2016 MITSUBISHI ELECTRIC CORPORATION
Distributed in Mar. 2016. No. OBH753 REVISED EDITION-A
Distributed in Feb. 2016. No. OBH753
Made in Japan

New publication, effective Mar. 2016
Specifications are subject to change without notice.