



# Split-type Air-Conditioner

**MXZ-3C24NA2**

**MXZ-3C30NA2**

**MXZ-4C36NA2**

## Installation Manual

For INSTALLER

- This manual only describes the installation of outdoor unit.  
When installing the indoor unit, refer to the installation manual of indoor unit.  
Any structural alterations necessary for installation must comply with local building code requirements.

**English**

## Notice d'installation

Destinée à l'INSTALLATEUR

- Cette notice ne décrit que l'installation de l'appareil extérieur.  
Lors de l'installation de l'appareil intérieur, consultez la notice d'installation de cet appareil.  
Toute altération structurelle requise pour l'installation doit être conforme aux exigences du code du bâtiment local.

**Français**

## Manual de instalación

Para el INSTALADOR

- En este manual sólo se describe la instalación de la unidad exterior.  
Para instalar la unidad interior, consulte el manual de instalación de dicha unidad.  
Cualquier modificación estructural necesaria para llevar a cabo la instalación deberá cumplir las normas de edificación locales.

**Español**

**CONTENTS**

1. BEFORE INSTALLATION ..... 1  
 2. OUTDOOR UNIT INSTALLATION ..... 4  
 3. FLARING WORK AND PIPE CONNECTION ..... 5  
 4. PURGING PROCEDURES, LEAK TEST, AND TEST RUN ..... 5  
 5. PUMPING DOWN ..... 7

**Required Tools for Installation**

Phillips screwdriver	5/32 in. (4 mm) hexagonal wrench
Level	Flare tool for R410A
Scale	Gauge manifold for R410A
Utility knife or scissors	Vacuum pump for R410A
Torque wrench	Charge hose for R410A
Wrench (or spanner)	Pipe cutter with reamer

**1. BEFORE INSTALLATION**

**1-1. THE FOLLOWING SHOULD ALWAYS BE OBSERVED FOR SAFETY**

- Be sure to read "THE FOLLOWING SHOULD ALWAYS BE OBSERVED FOR SAFETY" before installing the air conditioner.
- Be sure to observe the warnings and cautions specified here as they include important items related to safety.
- After reading this manual, be sure to keep it together with the OPERATING INSTRUCTIONS for future reference.

**⚠ WARNING (Could lead to death, serious injury, etc.)**

- **Do not install the unit by yourself (user).**  
Incomplete installation could cause fire or electric shock, injury due to the unit falling, or leakage of water. Consult the dealer from whom you purchased the unit or a qualified installer.
- **Perform the installation securely referring to the installation manual.**  
Incomplete installation could cause fire or electric shock, injury due to the unit falling, or leakage of water.
- **When installing the unit, use appropriate protective equipment and tools for safety.**  
Failure to do so could cause injury.
- **Install the unit securely in a place which can bear the weight of the unit.**  
If the installation location cannot bear the weight of the unit, the unit could fall causing injury.
- **Perform electrical work according to the installation manual and be sure to use an exclusive circuit. Do not connect other electrical appliances to the circuit.**  
If the capacity of the power circuit is insufficient or there is incomplete electrical work, it could result in a fire or an electric shock.
- **Do not damage the wires by applying excessive pressure with parts or screws.**  
Damaged wires could cause fire.
- **Be sure to cut off the main power in case of setting up the indoor P.C. board or wiring works.**  
Failure to do so could cause electric shock.
- **Use the specified wires to connect the indoor and outdoor units securely and attach the wires firmly to the terminal block connecting sections so the stress of the wires is not applied to the sections.**  
Incomplete connecting and securing could cause fire.
- **Do not install the unit in a place where inflammable gas may leak.**  
If gas leaks and accumulates in the area around the unit, it could cause an explosion.
- **Do not use intermediate connection of the power cord or the extension cord and do not connect many devices to one AC outlet.**  
It could cause a fire or an electric shock due to defective contact, defective insulation, exceeding the permissible current, etc.
- **Be sure to use the parts provided or specified parts for the installation work.**  
The use of defective parts could cause an injury or leakage of water due to a fire, an electric shock, the unit falling, etc.
- **When plugging the power supply plug into the outlet, make sure that there is no dust, clogging, or loose parts in both the outlet and the plug. Make sure that the power supply plug is pushed completely into the outlet.**  
If there is dust, clogging, or loose parts on the power supply plug or the outlet, it could cause electric shock or fire. If loose parts are found on the power supply plug, replace it.
- **Attach the electrical cover to the indoor unit and the service panel to the outdoor unit securely.**
- **When installing, relocating, or servicing the unit, make sure that no substance other than the specified refrigerant (R410A) enters the refrigerant circuit.**  
Any presence of foreign substance such as air can cause abnormal pressure rise and may result in explosion or injury. The use of any refrigerant other than that specified for the system will cause mechanical failure, system malfunction, or unit breakdown. In the worst case, this could lead to a serious impediment to securing product safety.
- **Do not discharge the refrigerant into the atmosphere. If refrigerant leaks during installation, ventilate the room.**  
If refrigerant comes in contact with a fire, harmful gas could be generated. Refrigerant leakage may cause suffocation. Ventilate the room.
- **Check that the refrigerant gas does not leak after installation has been completed.**  
If refrigerant gas leaks indoors, and comes into contact with the flame of a fan heater, space heater, stove, etc., harmful substances will be generated.
- **Use appropriate tools and piping materials for installation.**  
The pressure of R410A is 1.6 times more than R22. Not using appropriate tools or materials and incomplete installation could cause the pipes to burst or injury.
- **When pumping down the refrigerant, stop the compressor before disconnecting the refrigerant pipes.**  
If the refrigerant pipes are disconnected while the compressor is running and the stop valve is open, air could be drawn in and the pressure in the refrigeration cycle could become abnormally high. This could cause the pipes to burst or injury.
- **When installing the unit, securely connect the refrigerant pipes before starting the compressor.**  
If the compressor is started before the refrigerant pipes are connected and when the stop valve is open, air could be drawn in and the pressure in the refrigeration cycle could become abnormally high. This could cause the pipes to burst or injury.
- **Fasten a flare nut with a torque wrench as specified in this manual.**  
If fastened too tight, a flare nut may break after a long period and cause refrigerant leakage.
- **The unit shall be installed in accordance with national wiring regulations.**
- **Ground the unit correctly.**  
Do not connect the ground to a gas pipe, water pipe, lightning rod or telephone ground. Defective grounding could cause electric shock.
- **Be sure to install a Ground Fault Interrupt (GFI) circuit breaker.**  
Failure to install a Ground Fault Interrupt (GFI) circuit breaker may result in electric shock or fire.

**⚠ CAUTION (Could lead to serious injury in particular environments when operated incorrectly.)**

- **Perform the drainage/piping work securely according to the installation manual.**  
If there is defect in the drainage/piping work, water could drop from the unit, soaking and damaging household goods.
- **Do not touch the air inlet or the aluminum fins of the outdoor unit.**  
This could cause injury.
- **Do not install the outdoor unit where small animals may live.**  
If small animals enter and touch the electric parts inside the unit, it could cause a malfunction, smoke emission, or fire. Also, advise user to keep the area around the unit clean.

**1-2. SPECIFICATIONS**

Model	Power supply		Pipe length and height difference *1, *2, *3, *4, *5, *6			
	Rated Voltage	Frequency	Max. pipe length per indoor unit / for multi-system	Max. height difference	Max. no. of bends per indoor unit / for multi system	Refrigerant adjustment A *7
MXZ-3C24NA2 MXZ-3C30NA2 MXZ-4C36NA2	208 / 230 V	60 Hz	82 ft. (25 m) / 230 ft. (70 m)	49 ft. (15 m)	25 / 70	1.08 oz each 5 ft. (20 g/m)

\*1 Never use pipes with thickness less than specified. The pressure resistance will be insufficient.

\*2 Use a copper pipe or a copper-alloy seamless pipe.

\*3 Be careful not to crush or bend the pipe during pipe bending.

\*4 Refrigerant pipe bending radius must be 4 in. (100 mm) or more.

\*5 Insulation material : Heat resisting foam plastic 0.045 specific gravity

\*6 Be sure to use the insulation of specified thickness. Excessive thickness may cause incorrect installation of the indoor unit and insufficient thickness may cause dew drippage.

\*7 If pipe length exceeds 98 ft. (30 m), additional refrigerant (R410A) charge is required. (No additional charge is required for pipe length less than 98 ft. (30 m).)

$$\text{Additional refrigerant (ft.)} = A \times \frac{(\text{pipe length (ft.)} - 98)}{5}$$

$$\text{Additional refrigerant (m)} = A \times (\text{pipe length (m)} - 30)$$

### 1-3. SELECTING OPTIONAL DIFFERENT-DIAMETER JOINTS

If the diameter of connection pipe does not match the port size of outdoor unit, use optional different-diameter joints according to the following table.

(Unit: inch (mm))

Port size of outdoor unit			Optional different-diameter joints (port size of outdoor unit → diameter of connection pipe)
MXZ-3C	MXZ-4C	Liquid / Gas	1/4 (6.35) → 3/8 (9.52) : PAC-493PI 3/8 (9.52) → 1/2 (12.7) : MAC-454JP-E 3/8 (9.52) → 5/8 (15.88) : PAC-SG76RJ-E 1/2 (12.7) → 3/8 (9.52) : MAC-A455JP-E 1/2 (12.7) → 5/8 (15.88) : MAC-A456JP-E  Refer to the installation manual of indoor unit for the diameter of connection pipe of indoor unit.
A UNIT		1/4 (6.35) / 1/2 (12.7)	
B - C UNIT	B - D UNIT	1/4 (6.35) / 3/8 (9.52)	

### 1-4. SELECTING THE INSTALLATION LOCATION

- Where it is not exposed to strong wind.
- Where airflow is good and dustless.
- Where rain or direct sunshine can be avoided as much as possible.
- Where neighbours are not annoyed by operation sound or hot air.
- Where rigid wall or support is available to prevent the increase of operation sound or vibration.
- Where there is no risk of combustible gas leakage.
- When installing the unit, be sure to secure the unit legs.
- Where it is at least 10 ft. (3 m) away from the antenna of TV set or radio. Operation of the air conditioner may interfere with radio or TV reception in areas where reception is weak. An amplifier may be required for the affected device.
- Install the unit horizontally.
- Please install it in an area not affected by snowfall or blowing snow. In areas with heavy snow, please install a canopy, a pedestal and/or some baffle boards.

**Note:**

It is advisable to make a piping loop near outdoor unit so as to reduce vibration transmitted from there.

**Note:**

When operating the air conditioner in low outside temperature, be sure to follow the instructions described below.

- Never install the outdoor unit in a place where its air inlet/outlet side may be exposed directly to wind.
- To prevent exposure to wind, install the outdoor unit with its air inlet side facing the wall.
- To prevent exposure to wind, it is recommended to install a baffle board on the air outlet side of the outdoor unit.

Avoid the following places for installation where air conditioner trouble is liable to occur.

- Where flammable gas could leak.
- Where there is much machine oil.
- Salty places such as the seaside.
- Where sulfide gas is generated such as a hot spring.
- Where there is high-frequency or wireless equipment.
- Where there is emission of high levels of VOCs, including phthalate compounds, formaldehyde, etc., which may cause chemical cracking.

### FREE SPACE REQUIRED AROUND OUTDOOR UNIT

#### 1. Obstacles above

When there is no obstacle in front and on the sides of the unit, it is allowed to install the unit where an obstacle is above the unit only if the space shown in the figure is provided.

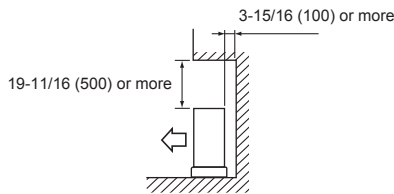

#### 2. Front (blowing) side open

As long as space indicated in the figure is provided, it is allowed to install the unit where obstacles are behind and on the sides of the unit. (No obstacle above the unit)

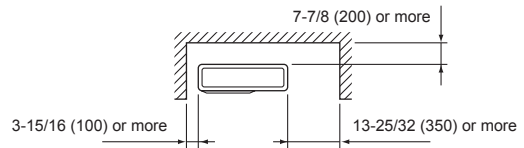

#### 3. Obstacles in front (blowing) only

When there is an obstacle in front of the unit as shown in the figure, open space above, behind, and on the sides of the unit is required.

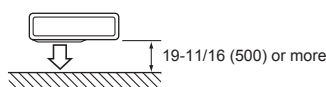

#### 4. Obstacles in front and behind

The unit can be used by attaching an optional outdoor blowing guide (PAC-SH96SG-E) (but both sides and top are open).

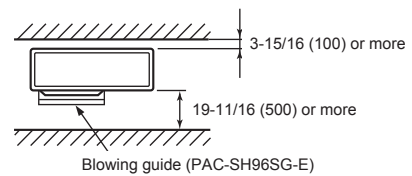

#### 5. Obstacles in front, behind and on side(s)

- When installing the unit in an area that is enclosed with walls such as a verandah, be sure to have enough space as shown below. In this case, the air conditioning capacity and power consumption might deteriorate.
- When installing two or more units, do not install the units in front or behind each other.

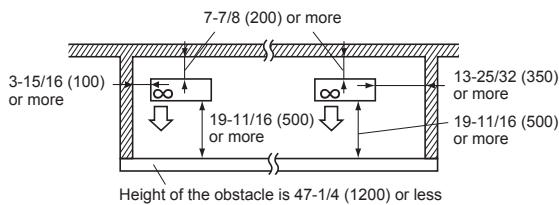

#### 6. Service space

Provide space for service and maintenance as shown in the figure.

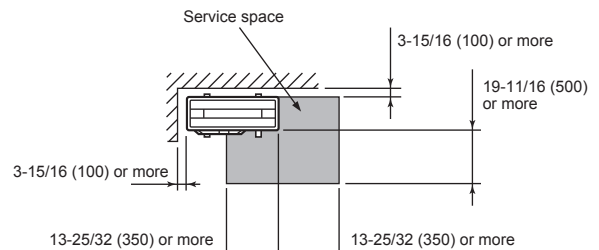

(Unit: inch (mm))

# 1-5. INSTALLATION DIAGRAM

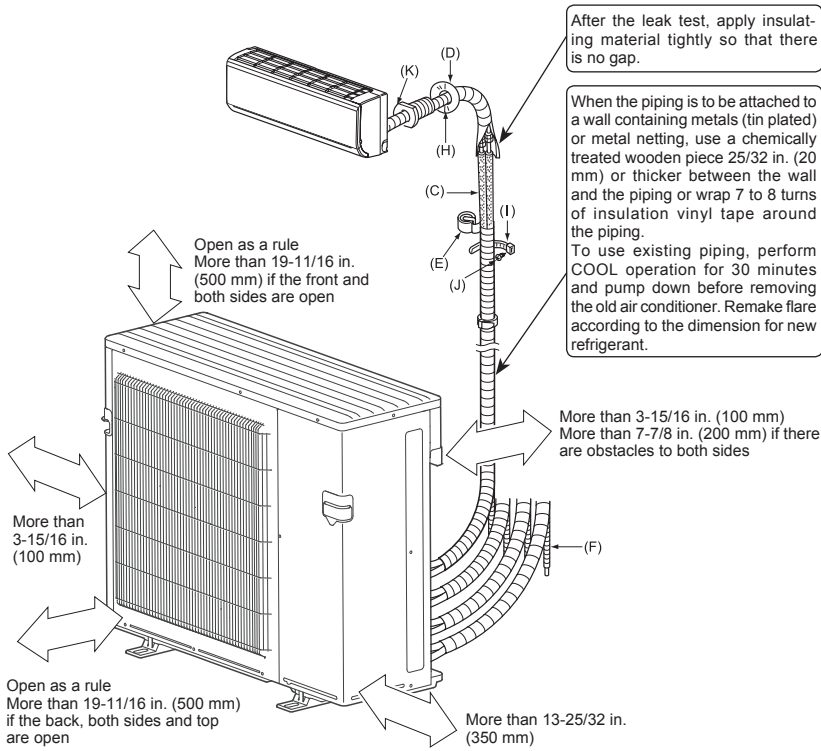

## PARTS TO BE PROVIDED AT YOUR SITE

(A)	Power supply cord*	1
(B)	Indoor/outdoor unit connecting wire*	1
(C)	Extension pipe	1
(D)	Wall hole cover	1
(E)	Piping tape	1
(F)	Extension drain hose (or soft PVC hose, 19/32 in. (15 mm) inner diameter or hard PVC pipe VP16)	1
(G)	Refrigeration oil	Little amount
(H)	Putty	1
(I)	Pipe fixing band	2 to 7
(J)	Fixing screw for (I)	2 to 7
(K)	Wall hole sleeve	1
(L)	Soft PVC hose, 19/32 in. (15 mm) inner diameter or hard PVC pipe VP16 for drain socket (1)	1

### \* Note:

Place indoor/outdoor unit connecting wire (B) and power supply cord (A) at least 3 ft. (1 m) away from the TV antenna wire.

The "Q'ty" for (B) to (K) in the above table is quantity to be used per indoor unit.

Units should be installed by licensed contractor according to local code requirements.

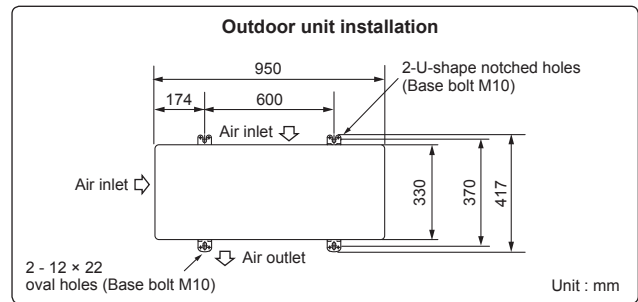
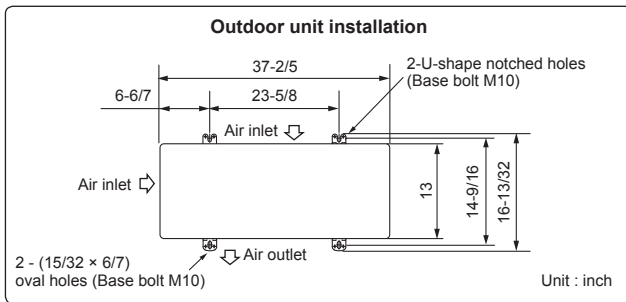

## 2. OUTDOOR UNIT INSTALLATION

### 2-1. INSTALLING THE UNIT

- Be sure to fix the unit's legs with bolts when installing it.
- Be sure to install the unit firmly to ensure that it does not fall by an earthquake or a gust.
- Refer to the figure in the right for concrete foundation.
- Do not use the drain socket and the drain caps in the cold region. Drain may freeze and it makes the fan stop.

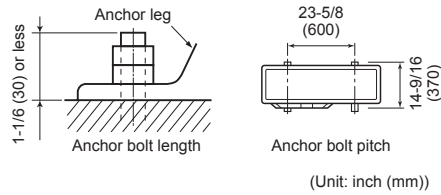
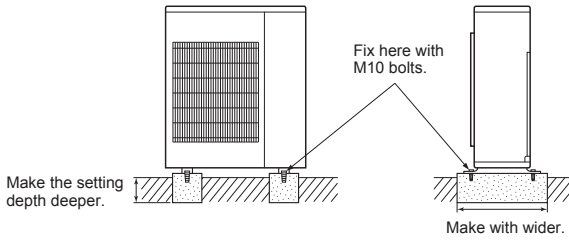

### 2-2. CONNECTING WIRES FOR OUTDOOR UNIT

- Be sure to use special circuits for room air conditioner.
- Wiring work should be based on applicable technical standards.
- Wiring connections should be made following the diagram.
- Screws should be tightened so they won't loosen.

ELECTRICAL SPECIFICATIONS			
OUTDOOR UNIT	MXZ-3C24NA2	MXZ-3C30NA2	MXZ-4C36NA2
Power supply (V, PHASE, Hz)	208/230, 1, 60		
Max. Fuse size (time delay) (A)	25		
Min. Circuit Ampacity (A)	22.1		23.1
Fan motor (F.L.A)	2.43		2.43
Compressor	(R.L.A)	12	12
	(L.R.A)	13.7	13.7
Control voltage	Indoor unit-Remote controller : (Wireless) Indoor unit-Outdoor unit : DC12-24V		

- 1) Remove the service panel.
- 2) Remove the conduit plate.
- 3) Attach the conduit connector to conduit plate with lock nut then secure it to the unit with screws.
- 4) Connect ground wires to the TB support.
- 5) Loosen terminal screw, and connect indoor/outdoor unit connecting wire (B) from the indoor unit correctly on the terminal block. Be careful not to make mis-wiring. Fix the wire to the terminal block securely so that no part of its core is appeared, and no external force is conveyed to the connecting section of the terminal block.
- 6) Firmly tighten the terminal screws to prevent them from loosening. After tightening, pull the wires lightly to confirm that they do not move.
- 7) Perform 5) and 6) for each indoor unit.
- 8) Connect power supply cord (A).
- 9) Close the service panel securely. Make sure that 3-2. PIPE CONNECTION is completed.

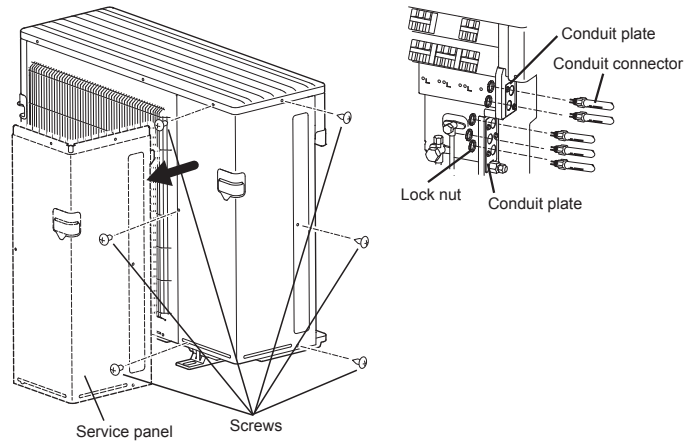

- Connecting order
- Connect the terminal block in following order.  
A→B→C→D→P
  - D unit is for 4C36NA2 only

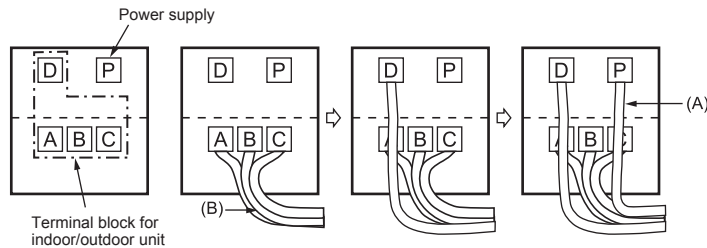

#### Remark:

- \* A disconnect switch should be required. Check the local code.
- \*\* Use a ring tongue terminal in order to connect a ground wire to terminal.

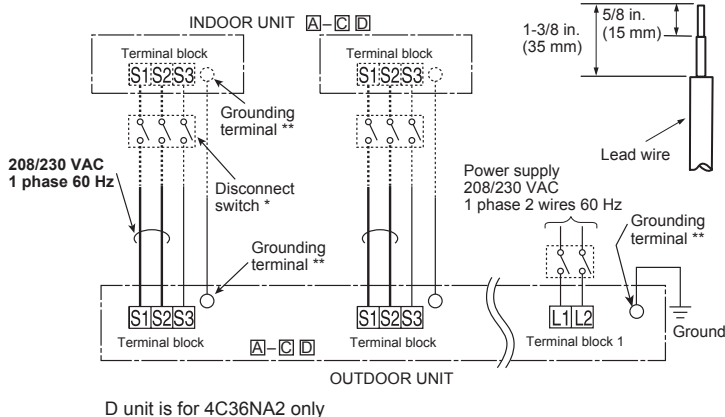

- Connect wires to the matching numbers of terminals.
- Be sure to attach each screw to its correspondent terminal when securing the cord and/or the wire to the terminal block.

#### CONNECTING WIRES AND CONNECTING GROUND WIRE

- Use solid conductor Min. AWG14 or stranded conductor Min. AWG14.
- Use double insulated copper wire with 600 V insulation.
- Use copper conductors only.
- \* Follow local electrical code.

#### POWER SUPPLY CABLE AND GROUND WIRE

- Use solid or stranded conductor Min. AWG12.
- Use copper conductors only.
- \* Follow local electrical code.

#### ⚠ WARNING:

Use the indoor/outdoor unit connecting wire that meets the Standards to connect the indoor and outdoor units and fix the wire to the terminal block securely so that no external force is conveyed to the connecting section of the terminal block. An incomplete connection or fixing of the wire could result in a fire.

For future servicing, give extra length to the connecting wires.

### 3. FLARING WORK AND PIPE CONNECTION

#### 3-1. FLARING WORK

- 1) Cut the copper pipe correctly with pipe cutter. (Fig. 1, 2)
- 2) Completely remove all burrs from the cut cross section of pipe. (Fig. 3)
  - Aim the copper pipe downward while removing burrs to prevent burrs from dropping in the pipe.
- 3) Remove flare nuts attached to indoor and outdoor units, then put them on pipe having completed burr removal. (Not possible to put them on after flaring work.)
- 4) Flaring work (Fig. 4, 5). Firmly hold copper pipe in the dimension shown in the table. Select A inch (mm) from the table according to the tool selected.
- 5) Check
  - Compare the flared work with Fig. 6.
  - If flare is noted to be defective, cut off the flared section and do flaring work again.

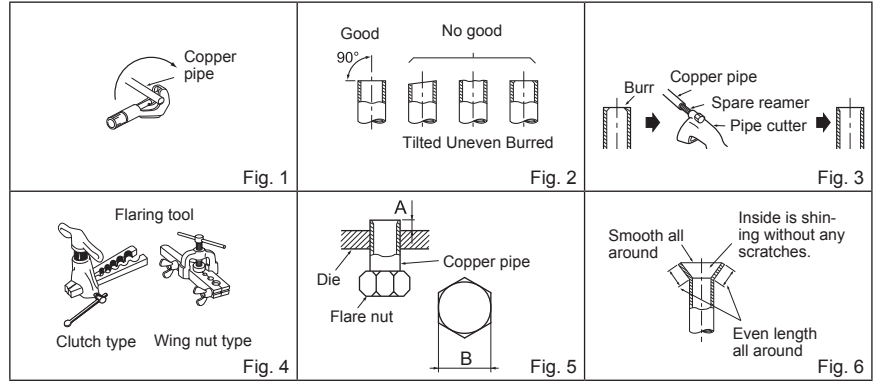

Pipe diameter [inch (mm)]	B [inch (mm)]	A [inch (mm)]			Tightening torque		
		Clutch type tool for R410A	Clutch type tool for R22	Wing nut type tool for R22	ft-lb	N·m	kgf·cm
1/4 (ø6.35)	21/32 (17)	0 to 0.02 (0 to 0.5)	0.04 to 0.06 (1.0 to 1.5)	0.06 to 0.08 (1.5 to 2.0)	10 to 13	13.7 to 17.7	140 to 180
3/8 (ø9.52)	7/8 (22)				25 to 30	34.3 to 41.2	350 to 420
1/2 (ø12.7)	1-1/32 (26)				36 to 42	49.0 to 56.4	500 to 575
5/8 (ø15.88)	1-5/32 (29)				54 to 58	73.5 to 78.4	750 to 800

#### 3-2. PIPE CONNECTION

- 1) Apply a thin coat of refrigeration oil (G) to the flared ends of the pipes and the pipe connections of the outdoor unit.
- 2) Align the center of the pipe with that of the pipe connections of the outdoor unit, then hand tighten the flare nut 3 to 4 turns.
- 3) Tighten the flare nut with a torque wrench as specified in the table.
  - Over-tightening may cause damage to the flare nut, resulting in refrigerant leakage.
  - Be sure to wrap insulation around the piping. Direct contact with the bare piping may result in burns or frostbite.

**⚠ WARNING**  
When installing the unit, securely connect the refrigerant pipes before starting the compressor.

#### 3-3. INSULATION AND TAPING

- 1) Cover piping joints with pipe cover.
- 2) For outdoor unit side, surely insulate every piping including valves.
- 3) Using piping tape (E), apply taping starting from the entry of outdoor unit.
  - Stop the end of piping tape (E) with tape (with adhesive agent attached).
  - When piping have to be arranged through above ceiling, closet or where the temperature and humidity are high, wind additional commercially sold insulation to prevent condensation.

**⚠ CAUTION**  
When there are the ports which are not used, make sure their nuts are tightened securely.

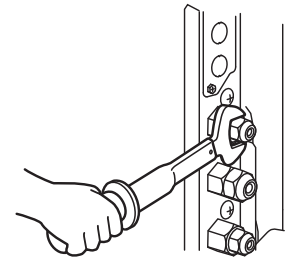

### 4. PURGING PROCEDURES, LEAK TEST, AND TEST RUN

#### 4-1. PURGING PROCEDURES AND LEAK TEST

- 1) Remove service port cap of stop valve on the side of the outdoor unit gas pipe. (The stop valves are fully closed and covered in caps in their initial state.)
- 2) Connect gauge manifold valve and vacuum pump to service port of stop valve on the gas pipe side of the outdoor unit.
- 3) Run the vacuum pump. (Vacuumize for more than 15 minutes.)
- 4) Check the vacuum with gauge manifold valve, then close gauge manifold valve, and stop the vacuum pump.
- 5) Leave as it is for one or two minutes. Make sure the pointer of gauge manifold valve remains in the same position. Confirm that pressure gauge shows -14.7 psi [Gauge] (-0.101 MPa).
- 6) Remove gauge manifold valve quickly from service port of stop valve.
- 7) Fully open all stop valves on the gas pipe and the liquid pipe. Operating without fully opening lowers the performance and this causes trouble.
- 8) Refer to 1-2., and charge the prescribed amount of refrigerant if needed. Be sure to charge slowly with liquid refrigerant. Otherwise, composition of the refrigerant in the system may be changed and affect performance of the air conditioner.
- 9) Tighten cap of service port to obtain the initial status.
- 10) Leak test

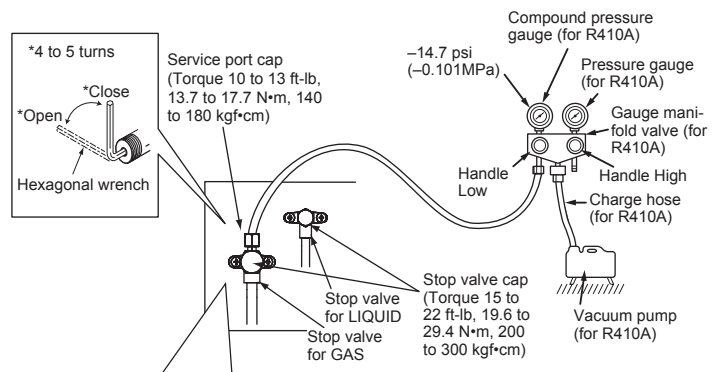

**Precautions when using the control valve**

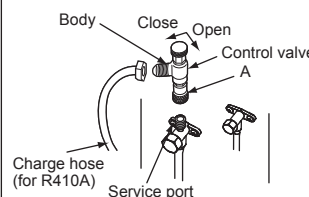

**When attaching the control valve to the service port, valve core may deform or loosen if excess pressure is applied. This may cause gas leak.**

When attaching the control valve to the service port, make sure that the valve core is in closed position, and then tighten part A. Do not tighten part A or turn the body when valve core is in open position.

## 4-2. GAS CHARGE

Perform gas charge to unit.

- 1) Connect gas cylinder to the service port of stop valve.
- 2) Perform air purge of the pipe (or hose) coming from refrigerant gas cylinder.
- 3) Replenish specified amount of the refrigerant, while operating the air conditioner for cooling.

### Note:

In case of adding refrigerant, comply with the quantity specified for the refrigerating cycle.

### CAUTION:

When charging the refrigerant system with additional refrigerant, be sure to use liquid refrigerant. Adding gas refrigerant may change the composition of the refrigerant in the system and affect normal operation of the air conditioner. Also, charge the liquid refrigerant slowly, otherwise the compressor will be locked.

To maintain the high pressure of the gas cylinder, warm the gas cylinder with warm water (under 104°F (40°C)) during cold season. But never use naked fire or steam.

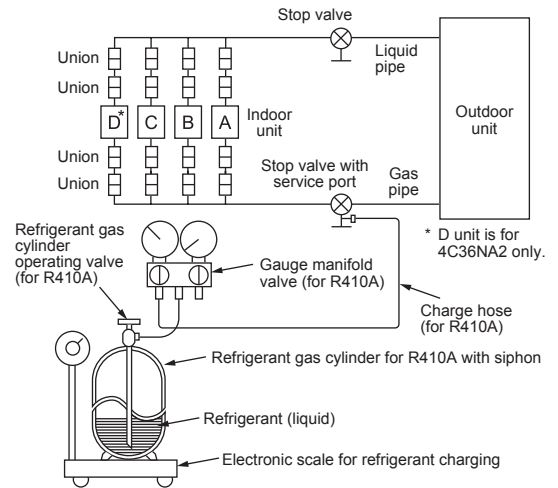

## 4-3. LOCKING THE OPERATION MODE OF THE AIR CONDITIONER (COOL, DRY, HEAT)

### Description of the function:

With this function, once the operation mode is locked to either COOL/DRY mode or HEAT mode, the air conditioner operates in that mode only.

- \* Changing the setting is required to activate this function. Please explain about this function to your customers and ask them whether they want to use it.

### [How to lock the operation mode]

- 1) Be sure to turn off the main power for the air conditioner before making the setting.
- 2) Set the "3" of SW1 on the outdoor controller board to ON to enable this function.
- 3) To lock the operation mode in COOL/DRY mode, set the "4" of SW1 on the outdoor controller board to OFF. To lock the operation in HEAT mode, set the same switch to ON.
- 4) Turn on the main power for the air conditioner.

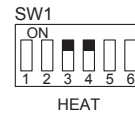
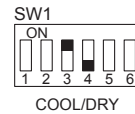
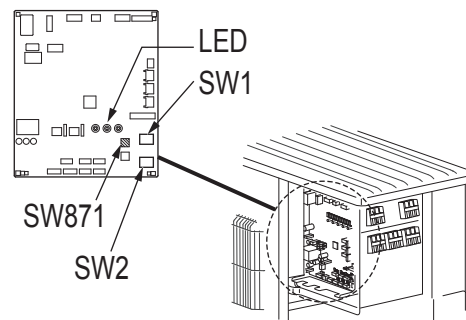

## 4-4. LOWERING THE OPERATION NOISE OF THE OUTDOOR UNIT

### Description of the function:

With this function, the operating noise of the outdoor unit can be lowered by reducing the operation load, for example, during nighttime in COOL mode. However, please note that the cooling and heating capacity may lower if this function is activated.

- \* Changing the setting is required to activate this function. Please explain about this function to your customers and ask them whether they want to use it.

### [How to lower the operating noise]

- 1) Be sure to turn off the main power for the air conditioner before making the setting.
- 2) Set the "5" of SW1 on the outdoor controller board to ON to enable this function.
- 3) Turn on the main power for the air conditioner.

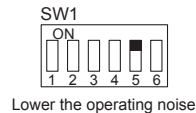

Lower the operating noise

#### 4-5. TEST RUN

- Test runs of the indoor units should be performed individually. See the installation manual coming with the indoor unit, and make sure all the units operate properly.
- If the test run with all the units is performed at once, possible erroneous connections of the refrigerant pipes and the indoor/outdoor unit connecting wires cannot be detected. Thus, be sure to perform the test run one by one.

##### About the restart protective mechanism

Once the compressor stops, the restart preventive device operates so the compressor will not operate for 3 minutes to protect the air conditioner.

##### Wiring/piping correction function

This unit has a wiring/piping correction function which corrects wiring and piping combination. When there is possibility of incorrect wiring and piping combination, and confirming the combination is difficult, use this function to detect and correct the combination by following the procedures below.

Make sure that the following is done.

- Power is supplied to the unit.
- Stop valves are open.

##### Note:

During detection, the operation of the indoor unit is controlled by the outdoor unit. During detection, the indoor unit automatically stops operation. This is not a malfunction.

##### Procedure

Press the piping/wiring correction switch (SW871) 1 minute or more after turning on the power supply.

- Correction completes in 10 to 20 minutes. When the correction is completed, its result is shown by LED indication. Details are described in the following table.
- To cancel this function during its operation, press the piping/wiring correction switch (SW871) again.
- When the correction completed without error, do not press the piping/wiring correction switch (SW871) again.

When the result is "Not completed", press the piping/wiring correction switch (SW871) again to cancel this function. Then, confirm the wiring and piping combination in a conventional manner by operating the indoor units one by one.

- The operation is done while the power is supplied. Make sure not to contact parts other than the switch, including the P.C. board. This may cause electric shock or burn by hot parts and live parts around the switch. Contacting the live parts may cause P.C. board damage.
- To prevent electronic control P.C. board damage, make sure to perform static elimination before operating this function.

• This function does not operate when the outside temperature is 32°F (0°C) or below.

##### LED indication during detection:

LED1 (Red)	LED2 (Yellow)	LED3 (Green)
Lighted	Lighted	Once

##### Result of piping/wiring correction function

LED1 (Red)	LED2 (Yellow)	LED3 (Green)	Result
Lighted	Not lighted	Lighted	Completed (Problem corrected or normal)
Once	Once	Once	Not completed (Detection failed)
Other indications			Refer to "SAFETY PRECAUTIONS WHEN LED BLINKS" located behind the service panel.

#### 4-6. EXPLANATION TO THE USER

- Using the OPERATING INSTRUCTIONS, explain to the user how to use the air conditioner (how to use the remote controller, how to remove the air filters, how to remove or put the remote controller in the remote controller holder, how to clean, precautions for operation, etc.).
- Recommend the user to read the OPERATING INSTRUCTIONS carefully.

### 5. PUMPING DOWN

When relocating or disposing of the air conditioner, pump down the system following the procedure below so that no refrigerant is released into the atmosphere.

- 1) Turn off the breaker.
- 2) Connect the gauge manifold valve to the service port of the stop valve on the gas pipe side of the outdoor unit.
- 3) Fully close the stop valve on the liquid pipe side of the outdoor unit.
- 4) Turn on the breaker.
- 5) Start the emergency COOL operation on all the indoor units.
- 6) When the pressure gauge shows 0.1 to 0 psi [Gauge] (0.05 to 0 MPa), fully close the stop valve on the gas pipe side of the outdoor unit and stop the operation. (Refer to the indoor unit installation manual about the method for stopping the operation.)
  - \* If too much refrigerant has been added to the air conditioner system, the pressure may not drop to 0.1 to 0 psi [Gauge] (0.05 to 0 MPa), or the protection function may operate due to the pressure increase in the high-pressure refrigerant circuit. If this occurs, use a refrigerant collecting device to collect all of the refrigerant in the system, and then recharge the system with the correct amount of refrigerant after the indoor and outdoor units have been relocated.
- 7) Turn off the breaker. Remove the pressure gauge and the refrigerant piping.

#### WARNING

When pumping down the refrigerant, stop the compressor before disconnecting the refrigerant pipes. The compressor may burst and cause injury if any foreign substance, such as air, enters the pipes.



## TABLE DES MATIERES

1. AVANT L'INSTALLATION .....	1
2. INSTALLATION DE L'APPAREIL EXTÉRIEUR .....	4
3. TRAVAUX D'ÉVASEMENT ET RACCORDEMENT DES TUYAUX .....	5
4. PROCÉDURES DE PURGE, TEST DE CONTRÔLE DES FUITES ET ESSAI DE FONCTIONNEMENT ...	5
5. PURGE .....	7

## Outils nécessaires à l'installation

Tournevis Phillips	Clé hexagonale de 5/32 po. (4 mm)
Niveau	Outil d'évasement pour le modèle R410A
Règle graduée	Tubulure de jauge pour le modèle R410A
Couteau tout usage ou paire de ciseaux	Pompe à vide pour le modèle R410A
Clé dynamométrique	Tuyau de charge pour le modèle R410A
Clé à ouverture fixe (ou clé simple)	Coupe-tuyau avec alésoir

## 1. AVANT L'INSTALLATION

## 1-1. INSTRUCTIONS A RESPECTER A TOUT MOMENT PAR MESURE DE SECURITE

- Veuillez lire les "INSTRUCTIONS A RESPECTER A TOUT MOMENT PAR MESURE DE SECURITE" avant de procéder à l'installation du climatiseur.
- Veuillez respecter scrupuleusement les mises en garde contenues dans cette notice car elles concernent des points essentiels à la sécurité.
- Après avoir lu la présente notice, veuillez la conserver avec les NOTICE D'UTILISATION de l'appareil pour pouvoir la consulter ultérieurement.

## ⚠ AVERTISSEMENT (Peut entraîner la mort, des blessures graves, etc.)

- **N'installez jamais l'unité seul (utilisateur).**  
Une installation incomplète peut être à l'origine d'un incendie, d'une électrocution, de blessures suite à la chute de l'appareil ou de fuites d'eau. Consulter un revendeur local ou un installateur agréé.
- **Exécuter les travaux d'installation en toute sécurité conformément aux instructions de la notice d'installation.**  
Une installation incomplète peut être à l'origine d'un incendie, d'une électrocution, de blessures suite à la chute de l'appareil ou de fuites d'eau.
- **Lors de l'installation de l'appareil, utiliser l'équipement de protection et les outils adéquats, par mesure de sécurité.**  
Le non-respect de ces recommandations peut être à l'origine de blessures.
- **Par mesure de sécurité, installer l'appareil dans un endroit capable de supporter son poids.**  
Si l'appareil est installé dans un endroit incapable de supporter son poids, il pourrait tomber et blesser quelqu'un.
- **Exécuter les travaux d'électricité en toute sécurité conformément aux instructions de la notice d'installation et prévoir un circuit électrique réservé au climatiseur. Ne brancher aucun autre appareil électrique sur le circuit du climatiseur.**  
Un circuit électrique de capacité insuffisante ou une installation incorrecte peuvent être à l'origine d'un incendie ou d'une électrocution.
- **Pour éviter toute détérioration, veillez à ce que les pièces et les vis n'exercent pas de pression excessive sur les câbles.**  
Des câbles endommagés pourraient provoquer un incendie.
- **Toujours couper l'alimentation principale lors de l'installation de la carte à circuits imprimés du panneau de commande de l'unité interne ou lors d'une intervention sur le câblage électrique.**  
Le non-respect de ces recommandations peut être à l'origine d'une électrocution.
- **Utiliser les câbles spécifiés pour raccorder en toute sécurité les unités interne et externe et fixer les câbles solidement aux sections de raccordement des blocs de sorties de façon à ce qu'ils n'exercent aucune pression sur les sections de raccordement.**  
Un branchement incomplet et non sécurisé peut provoquer un incendie.
- **Ne pas installer l'appareil dans un endroit exposé à des fuites de gaz inflammable.**  
La fuite et l'accumulation de gaz autour de l'appareil peut entraîner des risques d'explosion.
- **Ne pas utiliser de raccord intermédiaire ou de rallonge pour brancher le cordon d'alimentation et ne pas brancher plusieurs appareils à une même prise secteur.**  
Un mauvais contact, une isolation insuffisante, un courant trop fort, etc. peuvent entraîner des risques d'incendie ou d'électrocution, etc.
- **Veiller à utiliser les pièces fournies ou spécifiées dans la notice lors des travaux d'installation.**  
L'utilisation de pièces défectueuses peut être à l'origine de blessures corporelles ou d'une fuite d'eau suite à un incendie, une électrocution, la chute de l'appareil, etc.
- **Au moment de brancher la fiche d'alimentation dans la prise secteur, veiller à dé poussiérer et nettoyer la fiche et la prise en contrôlant qu'aucun élément n'est desserré. S'assurer que la fiche d'alimentation est enfoncée à fond dans la prise secteur.**  
La présence de poussière, de saleté ou d'éléments desserrés dans la fiche d'alimentation ou la prise secteur peut être à l'origine d'une électrocution ou d'un incendie. Contrôler la fiche d'alimentation et remplacer les éléments desserrés éventuels.
- **Fixer correctement le couvercle du boîtier électrique de l'unité interne et le panneau de service de l'unité externe.**  
Si le couvercle du boîtier électrique de l'unité interne et/ou le panneau de service de l'unité externe sont mal fixés, ils risquent de provoquer un incendie ou une électrocution en raison de la poussière, de l'eau, etc. présentes dans le circuit.
- **Lors de l'installation, du déplacement ou de l'entretien de l'appareil, veiller à ce qu'aucune substance autre que le réfrigérant spécifié (R410A) ne pénètre dans le circuit de réfrigération.**  
La présence d'une substance étrangère, comme de l'air dans le circuit, peut provoquer une augmentation anormale de la pression et causer une explosion, voire des blessures. L'utilisation de réfrigérant autre que celui qui est spécifié pour le système provoquera une défaillance mécanique, un mauvais fonctionnement du système, ou une panne de l'appareil. Dans le pire des cas, la sécurité du produit pourrait être gravement mise en danger.
- **Ne libérez pas le réfrigérant dans l'atmosphère. En cas de fuite de réfrigérant pendant l'installation, aérez la pièce.**  
Tout contact entre le réfrigérant et une flamme pourrait provoquer l'émission de gaz toxiques. Des fuites de réfrigérant peuvent provoquer une asphyxie. Aérez la pièce.
- **A la fin de l'installation, aucune fuite de réfrigérant ne doit être présente sur le circuit.**  
En cas de fuite de réfrigérant dans une pièce, et si le réfrigérant entre en contact avec la partie chauffante d'un appareil de chauffage à ventilation, chauffage d'appoint, poêle, etc., des substances toxiques peuvent se dégager.
- **Utiliser les outils et l'équipement de tuyauterie adaptés à l'installation.**  
La pression du réfrigérant R410A est 1,6 fois supérieure à celle du R22. L'utilisation d'outils ou d'équipements inadaptés et une installation incomplète peuvent provoquer l'éclatement des tuyaux et blesser quelqu'un.
- **Pendant l'opération d'aspiration du réfrigérant, arrêter le compresseur avant de débrancher les tuyaux de réfrigérant.**  
Si les tuyaux de réfrigérant sont débranchés avant l'arrêt du compresseur et si le robinet d'arrêt est ouvert, de l'air pourrait être aspiré et la pression du cycle de réfrigération pourrait monter de façon anormale. Les tuyaux pourraient éclater et blesser quelqu'un.
- **Pendant l'installation de l'appareil, brancher correctement les tuyaux de réfrigérant avant de lancer le compresseur.**  
Si le compresseur démarre avant le branchement des tuyaux de réfrigérant et si le robinet d'arrêt est ouvert, de l'air pourrait être aspiré et la pression du cycle de réfrigération pourrait monter de façon anormale. Les tuyaux pourraient éclater et blesser quelqu'un.
- **Fixer un écrou évasé avec une clé dynamométrique comme indiqué dans cette notice.**  
Si l'écrou évasé est trop serré, il pourrait se rompre au bout de plusieurs années et provoquer une fuite de réfrigérant.
- **L'installation de l'appareil doit être conforme aux normes électriques nationales.**
- **Raccorder correctement l'unité à la terre.**  
Ne pas raccorder le câble de terre à un tuyau de gaz, une conduite d'eau, un paratonnerre ou le câble de terre d'un téléphone. Une mise à la terre incorrecte risquerait de provoquer une électrocution.
- **S'assurer d'installer un disjoncteur de fuites à la terre.**  
L'absence d'un disjoncteur de fuites à la terre peut entraîner un choc électrique ou un incendie.

## ⚠ PRECAUTION (Peut provoquer des blessures graves dans certains environnements si l'appareil n'est pas utilisé correctement.)

- **Réaliser les travaux de vidange/tuyauterie conformément aux instructions de la notice d'installation.**  
Si les travaux de vidange/tuyauterie ne sont pas réalisés correctement, de l'eau pourrait s'écouler et endommager le mobilier qui se trouve sous l'appareil.
- **Ne toucher ni à l'entrée d'air ni aux ailettes en aluminium de l'unité externe.**  
Risque de blessures.
- **Ne pas installer l'unité externe à proximité de l'habitat d'animaux de petite taille.**  
Si des animaux de petite taille pénètrent dans l'unité et entrent en contact avec les composants électriques, ils pourraient provoquer un dysfonctionnement, des émissions de fumée ou un incendie. Il convient également de conseiller à l'utilisateur de nettoyer régulièrement la périphérie de l'unité.

## 1-2. FICHE TECHNIQUE

Modèle	Alimentation		Longueur des tuyaux et différence de hauteur *1 *2, *3, *4, *5, *6			
	Tension nominale	Fréquence	Longueur max. des tuyaux par appareil intérieur / pour système à plusieurs appareils	Différence de hauteur max.	Nombre max. de coudes par appareil intérieur / pour système à plusieurs appareils	Dosage du réfrigérant A *7
MXZ-3C24NA2 MXZ-3C30NA2 MXZ-4C36NA2	208 / 230 V	60 Hz	82 ft. (25 m) / 230 ft. (70 m)	49 ft. (15 m)	25 / 70	1,08 once tous les 5 ft. (20 g/m)

\*1 N'utilisez jamais des tuyaux dont l'épaisseur est inférieure à celle recommandée. Leur résistance à la pression serait insuffisante.

\*2 Utilisez un tuyau en cuivre ou en alliage de cuivre sans soudure.

\*3 Veillez à ne pas écraser ou tordre le tuyau lors du cintrage.

\*4 Le rayon du cintrage d'un tuyau de réfrigérant doit être de 4 po. (100 mm) minimum.

\*5 Matériau d'isolation : mousse plastique résistante à la chaleur d'une densité de 0,045

\*6 Utilisez toujours un matériau isolant de l'épaisseur spécifiée. Une isolation trop épaisse pourrait être à l'origine d'une installation incorrecte de l'unité interne alors qu'une isolation trop fine pourrait provoquer des fuites.

\*7 Si la longueur du tuyau dépasse 98 ft. (30 m), une quantité supplémentaire de réfrigérant (R410A) doit être ajoutée. (Aucune quantité supplémentaire n'est nécessaire pour une longueur de tuyau inférieure à 98 ft. (30 m).)

$$\text{Quantité supplémentaire de réfrigérant (ft.)} = A \times \frac{(\text{longueur de tuyau (ft.)} - 98)}{5}$$

$$\text{Quantité supplémentaire de réfrigérant (m)} = A \times (\text{longueur de tuyau (m)} - 30)$$

### 1-3. SÉLECTION DE JOINTS DE DIAMÈTRE DIFFÉRENT EN OPTION

Si le diamètre des tuyaux de connexion ne correspond pas au diamètre de passage de l'appareil extérieur, utiliser des joints de diamètre différent en option selon le tableau suivant.

(Unité : pouce (mm))

Diamètre de passage de l'appareil extérieur			Joint de diamètre différent en option (diamètre de passage de l'appareil extérieur → diamètre du tuyau de connexion)
MXZ-3C	MXZ-4C	Liquide / Gaz	1/4 (6,35) → 3/8 (9,52) : PAC-493PI 3/8 (9,52) → 1/2 (12,7) : MAC-454JP-E 3/8 (9,52) → 5/8 (15,88) : PAC-SG76RJ-E 1/2 (12,7) → 3/8 (9,52) : MAC-A455JP-E 1/2 (12,7) → 5/8 (15,88) : MAC-A456JP-E
APPAREILS A		1/4 (6,35) / 1/2 (12,7)	Se reporter au manuel d'installation de l'appareil intérieur pour connaître le diamètre du tuyau de connexion de l'appareil intérieur.
UNIDAD B à C	UNIDAD B à D	1/4 (6,35) / 3/8 (9,52)	

### 1-4. CHOIX DE L'EMPLACEMENT D'INSTALLATION

- Emplacement ne favorisant pas une exposition à des vents violents.
- Emplacement favorisant une bonne circulation d'air sans poussière excessive.
- Emplacement ne favorisant pas une exposition à la pluie ou aux rayons directs du soleil.
- Emplacement ne générant pas de nuisance pour le voisinage (bruit de fonctionnement ou pulsation d'air chaud).
- Emplacement sur un mur ou un support rigides pour éviter toute propagation du bruit de fonctionnement ou vibration de l'appareil.
- Emplacement qui ne risque pas d'être exposé à des fuites de gaz combustible.
- Lors de l'installation, pensez à fixer les supports de l'appareil.
- Emplacement à 10 ft. (3 m) minimum de l'antenne TV ou radio. Le fonctionnement du climatiseur peut interférer avec la réception des ondes radio ou TV dans des régions où la réception est faible. Il peut s'avérer nécessaire de brancher un amplificateur sur l'appareil concerné.
- Toujours installer l'appareil à l'horizontale.
- Installer le climatiseur dans un endroit à l'abri du vent et de la neige. Dans un endroit soumis à de fortes chutes de neige, installer un abri, un socle et/ou des écrans de protection.

#### Remarque :

Il est conseillé de faire une boucle avec le tuyau le plus près possible de l'unité externe de façon à réduire les vibrations transmises par l'unité.

#### Remarque :

Si vous utilisez le climatiseur alors que la température extérieure est basse, veillez à observer les instructions ci-dessous.

- N'installez jamais l'unité externe dans un endroit où le côté présentant l'entrée/la sortie d'air risque d'être directement exposé au vent.
- Pour protéger l'unité externe du vent, installez-la de façon à ce que l'entrée d'air soit face au mur.
- Pour éviter toute exposition au vent, il est recommandé d'installer un écran de protection du côté de la sortie d'air de l'unité externe.

Pour éviter tout problème de fonctionnement, évitez d'installer le climatiseur dans les endroits suivants :

- En présence de fuites de gaz inflammable.
- En présence d'une grande quantité d'huile de machine.
- Dans les régions où l'air est très salin, comme en bord de mer.
- En présence de gaz sulfurique, comme dans les stations thermales.
- En présence d'équipements haute fréquence ou sans fil.
- En présence d'émissions importantes de COV (composés organiques volatiles), dont les composés de phthalate, le formaldéhyde etc., qui peuvent provoquer un craquage chimique.

## ESPACE REQUIS AUTOUR DE L'APPAREIL EXTÉRIEUR

### 1. Obstacles au-dessus de l'appareil

En l'absence d'obstacle sur le devant et d'un côté ou de l'autre de l'appareil, ce dernier peut être installé même si un obstacle se trouve au-dessus de lui à condition que l'espace qui sépare l'appareil de l'obstacle soit au moins équivalent à celui indiqué sur l'illustration.

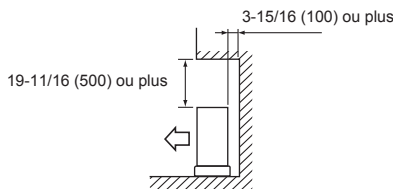

### 3. Obstacles sur le devant (soufflerie) uniquement

En présence d'un obstacle sur le devant de l'appareil comme indiqué sur l'illustration, il est indispensable de laisser un espace libre au-dessus, derrière et sur les côtés de l'appareil.

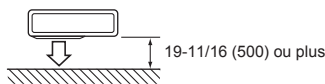

### 5. Obstacles sur le devant, derrière et sur le(s) côté(s)

- Si vous devez installer l'appareil dans un endroit ceint de murs de type véranda, veillez à disposer de suffisamment d'espace comme indiqué ci-dessous. Si ce n'est pas le cas, les performances du climatiseur risquent de se détériorer et la consommation d'électricité pourrait augmenter.
- Si vous installez au moins deux appareils, veillez à ne pas les poser les uns devant ou derrière les autres.

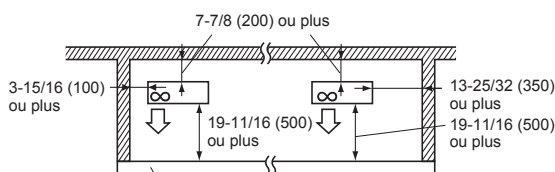

La hauteur de l'obstacle est inférieure ou égale à 47-1/4 (1200)

### 2. Devant (soufflerie) ouvert

Tant que l'espace qui sépare l'appareil de l'obstacle est au moins équivalent à celui indiqué sur l'illustration, l'appareil peut être installé même si des obstacles se trouvent derrière lui et d'un côté ou de l'autre. (Absence d'obstacle au-dessus de l'appareil)

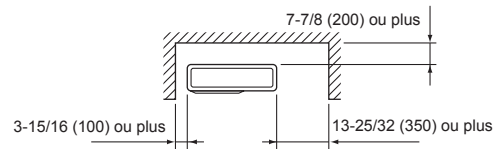

### 4. Obstacles sur le devant et derrière

L'appareil peut être utilisé en fixant un guidage de sortie d'air extérieur en option (PAC-SH96SG-E) (avec les deux côtés et le haut ouverts).

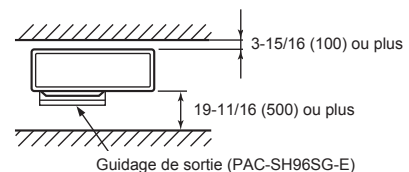

### 6. Espace d'entretien

Laissez un espace pour les travaux d'entretien comme indiqué sur l'illustration.

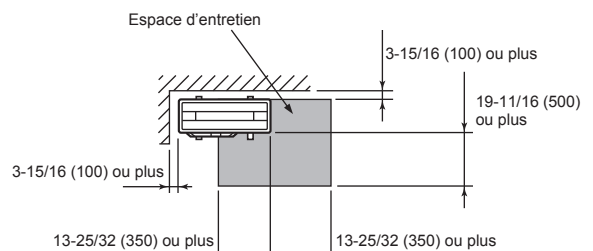

(Unité : pouce (mm))

# 1-5. SCHÉMA D'INSTALLATION

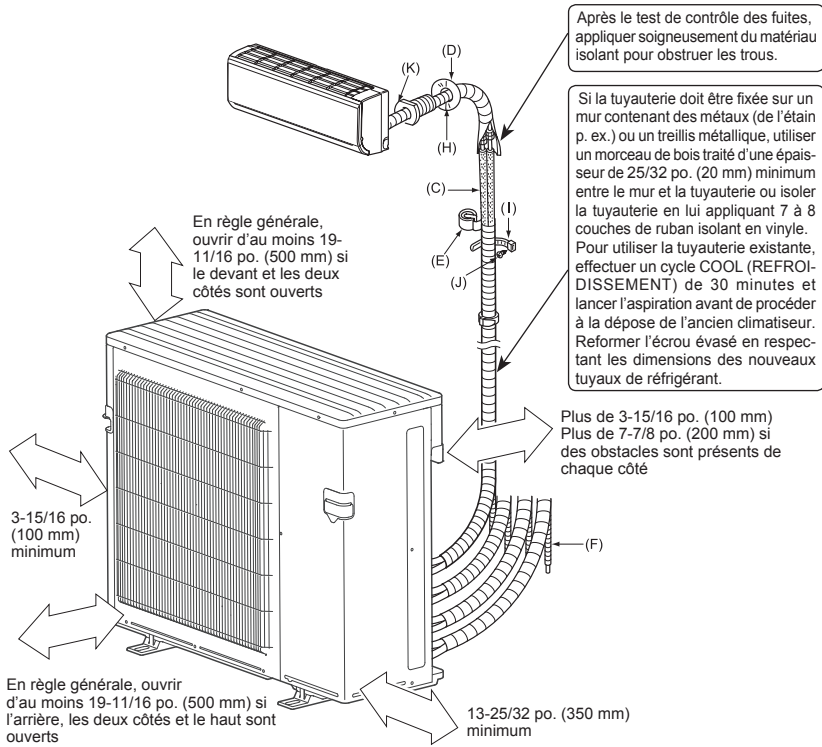

## PIÈCES À FOURNIR SUR PLACE

(A)	Câble d'alimentation*	1
(B)	Câble de connexion intérieur/extérieur*	1
(C)	Tuyau télescopique	1
(D)	Cache de l'orifice mural	1
(E)	Ruban de tuyauterie	1
(F)	Rallonge du tuyau flexible d'évacuation (ou tuyau flexible de chlorure de vinyle d'un diamètre intérieur de 19/32 po. (15 mm) ou tuyau VP16 de chlorure de vinyle)	1
(G)	Huile réfrigérante	Petite quantité
(H)	Mastic	1
(I)	Attache de fixation pour tuyau	2 à 7
(J)	Vis de fixation pour (I)	2 à 7
(K)	Manchon d'ouverture murale	1
(L)	Tuyau flexible en PVC (chlorure de vinyle) d'un diamètre intérieur de 19/32 po. (15 mm) ou tuyau rigide VP16 en PVC pour la douille d'évacuation (1)	1

### \* Remarque :

Placer le câble de connexion intérieur/extérieur (B) et le câble d'alimentation (A) à 3 ft. (1 m) minimum du câble de l'antenne TV.

La "quantité" pour (B) à (K) ci-dessus est la quantité à utiliser pour l'appareil intérieur.

Ces appareils doivent être installés par des entrepreneurs agréés conformément aux réglementations locales en vigueur.

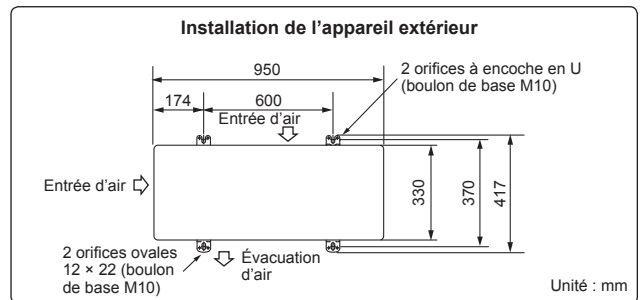
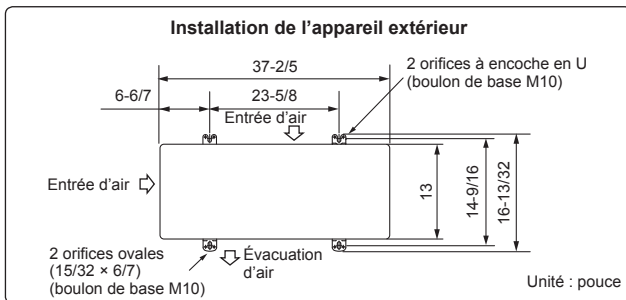

## 2. INSTALLATION DE L'APPAREIL EXTÉRIEUR

### 2-1. INSTALLATION DE L'APPAREIL

- S'assurer de bien attacher les pieds de l'appareil avec les boulons lors de l'installation.
- S'assurer d'installer l'appareil fermement pour qu'il ne tombe pas lors d'un tremblement de terre ou d'une tempête.
- Se référer à la figure ci-à droite pour les fondations.
- Ne pas utiliser la douille d'évacuation ni les bouchons d'évacuation en région froide. Le liquide d'évacuation risquerait de geler, ce qui provoquerait un arrêt du ventilateur.

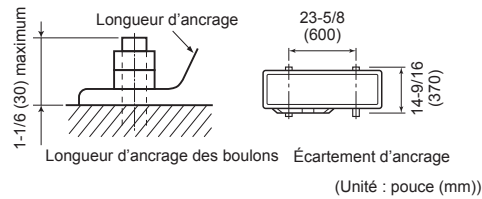
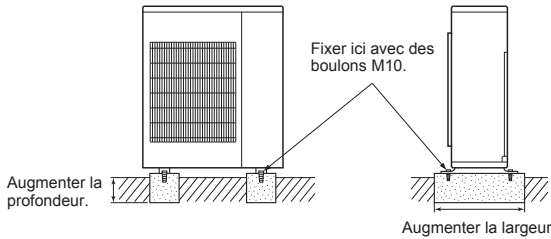

### 2-2. BRANCHEMENT DES CÂBLES DE L'APPAREIL EXTÉRIEUR

- Veiller à utiliser des circuits spéciaux pour le climatiseur.
- Le câblage doit être conforme aux normes techniques applicables.
- Le câblage doit être connecté conformément au schéma.
- Les vis doivent être serrées de façon à éviter leur desserrage.

SPÉCIFICATIONS ÉLECTRIQUES			
APPAREIL EXTÉRIEUR	MXZ-3C24NA2	MXZ-3C30NA2	MXZ-4C36NA2
Alimentation électrique (V, PHASE, Hz)	208/230, 1, 60		
Calibre max. de fusible (temporisé) (A)	25		
Courant admissible min. du circuit (A)	22,1		23,1
Moteur de ventilateur (F.L.A)	2,43		2,43
Compresseur	(R.L.A)	12	12
	(L.R.A)	13,7	13,7
Tension de commande	Unité interne-Télécommande : (sans fil) Appareil intérieur-Appareil extérieur : DC12-24V		

- 1) Retirer le panneau de service.
- 2) Déposer la plaque de conduit.
- 3) Fixer le connecteur du conduit sur la plaque de conduit à l'aide d'un contre-écrou, puis le fixer sur l'appareil à l'aide de vis.
- 4) Raccorder les fils de terre au support TB.
- 5) Retirer la vis de fixation du bloc de sortie et connecter le câble de connexion intérieur/extérieur (B) depuis l'appareil intérieur au bloc de sortie. Veiller à ne pas effectuer d'erreur de branchement. Fixer fermement le câble au bloc de sortie pour ne faire apparaître aucune partie de son noyau et n'appliquer aucune force extérieure à la section de raccordement du bloc de sortie.
- 6) Serrer fermement les vis de fixation du bloc de sortie afin d'éviter tout faux contact. Après l'opération de serrage, tirer légèrement sur les câbles pour s'assurer qu'ils sont bien fixés.
- 7) Effectuer les étapes 5) et 6) pour chaque appareil intérieur.
- 8) Brancher le câble d'alimentation (A).
- 9) Refermer le panneau de service. Vérifier que l'étape 3-2. RACCORDEMENT DES TUYAUX a été effectuée.

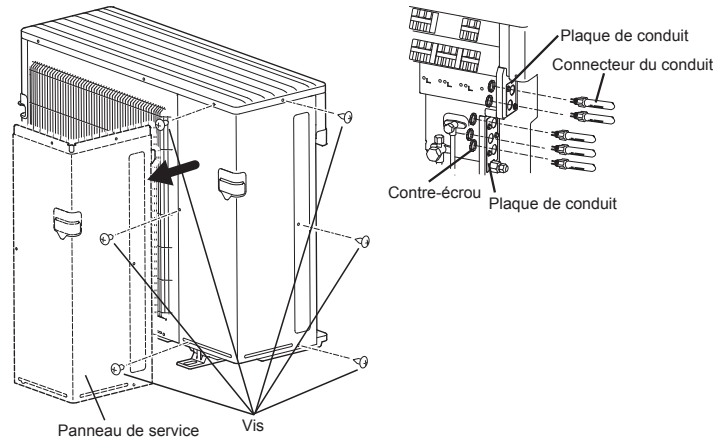

#### Ordre de branchement

- Raccordez le bloc de sorties dans l'ordre suivant.  
A → B → C → D → P  
Appareil D pour le modèle 4C36NA2 uniquement

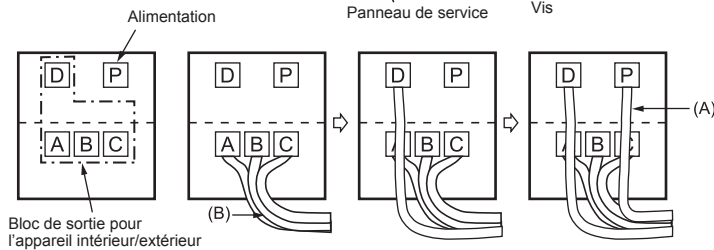

#### Remarque :

- \* Un sectionneur devrait être nécessaire. Vérifier le code local.
- \*\* Connecter un câble de mise à la terre à une borne à l'aide d'une cosse à anneau.

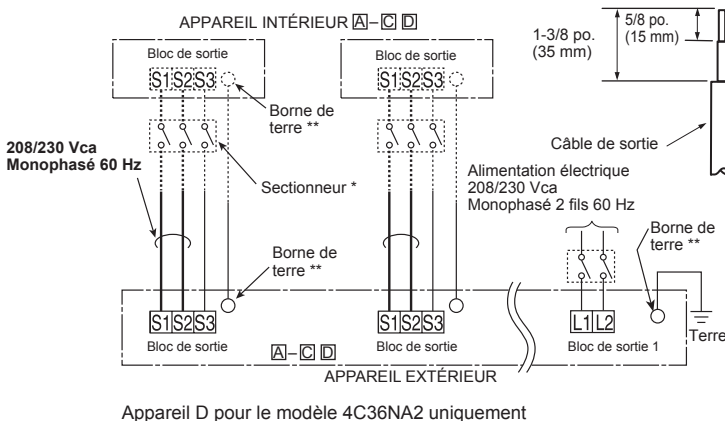

Appareil D pour le modèle 4C36NA2 uniquement

- Raccorder les fils aux bornes associées aux numéros correspondants.
- Lors du raccordement du cordon et/ou du fil au bloc de sortie, veiller à fixer chaque vis à la borne correspondante.

#### RACCORDEMENT DES FILS ET DU CÂBLE DE MISE À LA TERRE

- Utiliser un conducteur massif min. AWG14 ou un conducteur toronné min. AWG14.
- Utiliser un fil en cuivre à double isolation 600 V.
- Utiliser des conducteurs en cuivre uniquement.
- \* Respecter le code électrique local.

#### CÂBLE D'ALIMENTATION ÉLECTRIQUE ET CÂBLE DE MISE À LA TERRE

- Utiliser un conducteur massif ou toronné min. AWG12.
- Utiliser des conducteurs en cuivre uniquement.
- \* Respecter le code électrique local.

#### AVERTISSEMENT :

Utiliser le câble de connexion conforme aux normes techniques pour raccorder les unités interne et externe, et fixer le câble fermement sur la borne de sortie de façon que le côté raccordement de ce dernier ne soit soumis à aucune contrainte extérieure. Un raccordement incomplet ou une fixation incorrecte risqueraient de provoquer un incendie.

Prévoir une longueur de câble de raccordement supplémentaire en vue des entretiens ultérieurs.

### 3. TRAVAUX D'ÉVASEMENT ET RACCORDEMENT DES TUYAUX

#### 3-1. TRAVAUX D'ÉVASEMENT

- Coupez correctement le tuyau en cuivre avec un coupe-tuyaux. (Fig. 1, 2)
- Ebarbez parfaitement la partie tronçonnée du tuyau. (Fig. 3)
  - Dirigez le tuyau en cuivre vers le bas lors de l'ébarbage de façon à éviter que les bavures ne pénètrent dans le tuyau.
- Retirez les écrous à évasement fixés sur les unités interne et externe, puis posez-les sur le tuyau après avoir éliminé toutes les bavures. (Il est impossible de les poser après les travaux d'évasement.)
- Travaux d'évasement (Fig. 4, 5). Tenez fermement le tuyau de cuivre dans la dimension indiquée dans le tableau. Sélectionnez A en pouce (mm) dans le tableau en fonction de l'outil que vous utilisez.
- Contrôle
  - Comparez les travaux d'évasement avec la Fig. 6.
  - Si l'évasement n'est pas conforme à l'illustration, coupez la partie évasée et refaites l'évasement.

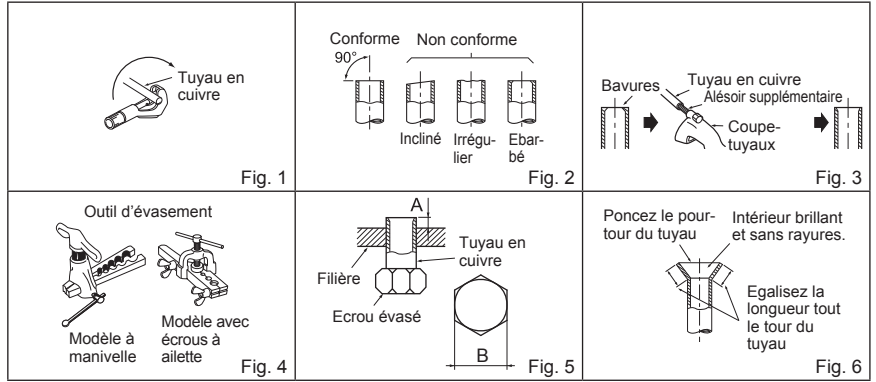

Diamètre du tuyau [pouce (mm)]	B [pouce (mm)]	A [pouce (mm)]			Couple de serrage		
		Outil type d'embrayage pour le modèle R410A	Outil type d'embrayage pour le modèle R22	Ecrou à oreilles pour le modèle R22	pi·lb	N·m	kgf·cm
1/4 (ø6,35)	21/32 (17)	0 à 0,02 (0 à 0,5)	0,04 à 0,06 (1,0 à 1,5)	0,06 à 0,08 (1,5 à 2,0)	10 à 13	13,7 à 17,7	140 à 180
3/8 (ø9,52)	7/8 (22)				25 à 30	34,3 à 41,2	350 à 420
1/2 (ø12,7)	1-1/32 (26)			0,08 à 1,0 (2,0 à 2,5)	36 à 42	49,0 à 56,4	500 à 575
5/8 (ø15,88)	1-5/32 (29)				54 à 58	73,5 à 78,4	750 à 800

#### 3-2. RACCORDEMENT DES TUYAUX

- Appliquez une fine couche d'huile réfrigérante (G) sur les embouts évasés des tuyaux ainsi que sur les raccords de tuyau de l'appareil extérieur.
- Alignez la partie médiane du tuyau sur les raccords de tuyau de l'appareil extérieur et serrez les écrous évasés à la main de 3 à 4 tours.
- Serrez l'écrou évasé avec une clé dynamométrique comme indiqué dans le tableau.
  - Un serrage excessif pourrait endommager l'écrou évasé et provoquer une fuite de réfrigérant.
  - Veillez à protéger la tuyauterie avec une gaine isolante. Tout contact direct avec la tuyauterie nue peut se traduire par des brûlures ou des engelures.

**⚠ AVERTISSEMENT**  
Pendant l'installation de l'appareil, branchez correctement les tuyaux de réfrigérant avant de lancer le compresseur.

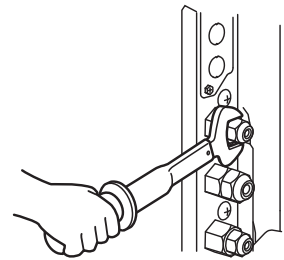

#### 3-3. ISOLATION THERMIQUE ET RUBANAGE

- Recouvrez les raccords de tuyauterie d'une bande isolante pour tuyaux.
- Du côté de l'unité externe, isolez correctement chaque tuyau, vannes incluses.
- Appliquez du ruban adhésif de tuyauterie (E) en commençant par l'entrée de l'unité externe.
  - Collez l'extrémité du ruban adhésif (E) (avec le produit adhésif fourni).
  - Si la tuyauterie doit passer dans le plafond, les toilettes ou dans un endroit où la température et l'humidité sont élevées, ajoutez une couche supplémentaire de bande isolante disponible dans le commerce pour éviter toute formation de condensation.

**⚠ PRECAUTION**  
Lorsque certains orifices ne sont pas utilisés, veuillez les obstruer en serrant correctement leur écrou respectif.

### 4. PROCEDURES DE PURGE, TEST DE CONTROLE DES FUITES ET ESSAI DE FONCTIONNEMENT

#### 4-1. PROCEDURES DE PURGE ET TEST DE CONTROLE DES FUITES

- Retirez le bouchon de l'ouverture de service du robinet d'arrêt du côté du conduit de gaz de l'unité externe. (A l'origine, les robinets d'arrêt sont complètement fermés et recouverts d'un capuchon.)
- Raccordez la vanne du collecteur à jauge et la pompe à vide à l'ouverture de service du robinet d'arrêt du côté du conduit de gaz de l'unité externe.
- Mettez la pompe à vide en marche. (Faites le vide pendant 15 minutes minimum.)
- Contrôlez la dépression ainsi obtenue avec la vanne du collecteur à jauge, puis fermez la vanne et arrêtez la pompe à vide.
- Patiencez pendant une minute ou deux. Assurez-vous que l'aiguille de la vanne du collecteur à jauge reste dans la même position. Vérifiez que le manomètre indique une pression de -14,7 psi [Jauge] (-0,101 MPa).
- Retirez rapidement la vanne du collecteur à jauge de l'ouverture de service du robinet d'arrêt.
- Ouvrez complètement les robinets d'arrêt des tuyaux de liquide et de gaz. La mise en service sans ouvrir complètement les robinets d'arrêt diminue le rendement de l'unité et peut être source de panne.
- Reportez-vous aux étapes 1-2. et chargez la quantité de réfrigérant recommandée si nécessaire. Veillez à charger lentement le liquide réfrigérant. Sinon, la composition de réfrigérant dans le système peut changer et affecter les performances du climatiseur.
- Serrez le bouchon de l'ouverture de service pour recréer les conditions d'origine.
- Test de contrôle des fuites.

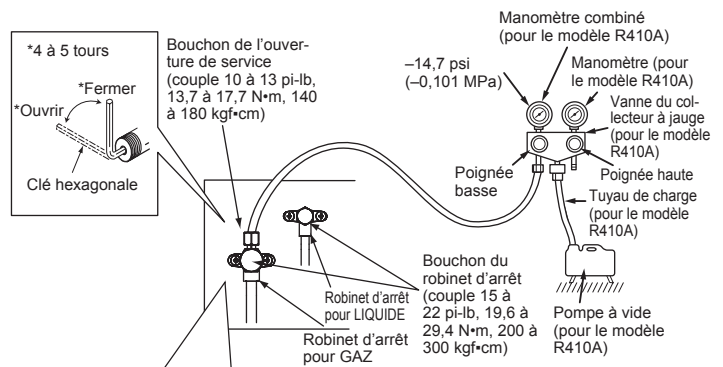

**Précautions à prendre lors de l'utilisation de la vanne de commande**

Corps Fermer Ouvrir Vanne de commande A

Tuyau de charge (pour le modèle R410A) Ouverture de service

**Lorsque vous fixez la vanne de commande à l'ouverture de service, le noyau de vanne peut se déformer ou se relâcher en cas de pression excessive. Cela peut entraîner une fuite de gaz.**

Lorsque vous fixez la vanne de commande à l'ouverture de service, veillez à ce que le noyau de vanne soit en position fermée, puis serrez la partie A. Ne serrez pas la partie A ou ne tournez pas le corps lorsque le noyau de vanne est en position ouverte.

## 4-2. RECHARGE DE GAZ

Charger du gaz pour l'appareil.

- 1) Relier la bouteille de gaz sur l'orifice de service du robinet d'arrêt.
- 2) Effectuer la purge d'air de la canalisation (ou du flexible) venant du cylindre de réfrigérant.
- 3) Charger la quantité de réfrigérant spécifiée tout en laissant fonctionner le climatiseur en mode de refroidissement.

### Remarque :

En cas d'ajout de réfrigérant, respecter la quantité précisée pour le cycle de réfrigération.

### PRECAUTION :

En cas de supplément de charge, assurez-vous de charger le réfrigérant sous sa forme liquide. Si le réfrigérant est chargé sous sa forme gazeuse, sa composition risque de se modifier à l'intérieur du système et le fonctionnement normal du climatiseur peut s'avérer impossible. Il convient, en outre, de remplir le système de réfrigérant le plus lentement possible car une charge trop rapide risque de bloquer le compresseur.

Pour maintenir une pression élevée dans le cylindre de gaz, le réchauffer avec de l'eau chaude (d'une température inférieure à 104°F (40°C)) pendant la saison froide. Ne jamais utiliser une flamme vive ou de la vapeur pour effectuer cette opération.

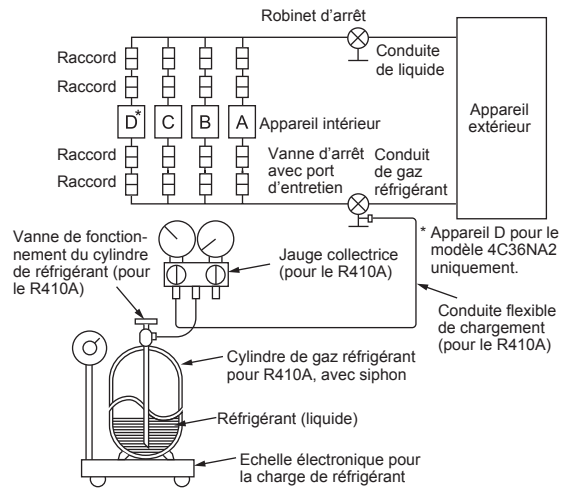

## 4-3. VERROUILLAGE DU MODE DE FONCTIONNEMENT DU CLIMATISEUR (REFROIDISSEMENT, DÉSHUMIDIFICATION, CHAUFFAGE)

### Description de la fonction :

Lorsque cette fonction est sélectionnée, si le mode de fonctionnement est bloqué sur COOL/DRY (REFROIDISSEMENT/DÉSHUMIDIFICATION) ou HEAT (CHAUFFAGE), le climatiseur fonctionne uniquement dans ce mode.

\* Il est nécessaire de modifier la configuration pour pouvoir sélectionner cette fonction. Présenter cette fonction aux clients et les inviter à l'utiliser.

### [Procédure de verrouillage du mode de fonctionnement]

- 1) Veiller à couper l'alimentation secteur du climatiseur avant de procéder à la programmation.
- 2) Régler le commutateur "3" du SW1 du panneau de commande extérieur sur ON pour activer cette fonction.
- 3) Pour verrouiller le fonctionnement en mode COOL/DRY (REFROIDISSEMENT/DÉSHUMIDIFICATION), régler le commutateur "4" du SW1 du panneau de commande extérieur sur OFF. Pour verrouiller le fonctionnement en mode HEAT (CHAUFFAGE), régler le même commutateur sur ON.
- 4) Mettre le climatiseur sous tension.

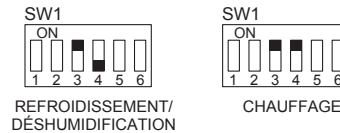
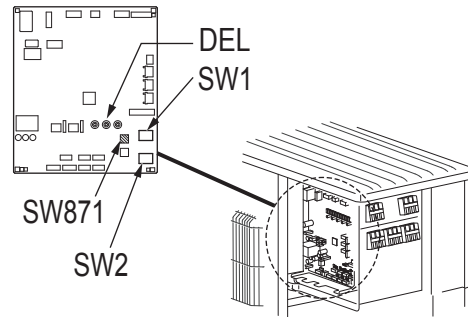

## 4-4. RÉDUCTION DU BRUIT DE FONCTIONNEMENT DE L'APPAREIL EXTÉRIEUR

### Description de la fonction :

Lorsque cette fonction est sélectionnée, il est possible de limiter le bruit de fonctionnement de l'appareil extérieur en réduisant la charge de fonctionnement, par exemple, pendant la nuit en mode COOL (REFROIDISSEMENT). Cependant, veuillez noter que les performances de refroidissement et de chauffage peuvent diminuer si cette fonction est sélectionnée.

\* Il est nécessaire de modifier la configuration pour pouvoir sélectionner cette fonction. Présenter cette fonction aux clients et les inviter à l'utiliser.

### [Procédure de réduction du bruit de fonctionnement]

- 1) Veiller à couper l'alimentation secteur du climatiseur avant de procéder à la programmation.
- 2) Régler le commutateur "5" du SW1 du panneau de commande extérieur sur ON pour activer cette fonction.
- 3) Mettre le climatiseur sous tension.

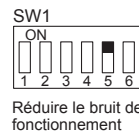

## 4-5. ESSAI

- Chaque appareil intérieur doit être soumis à un essai de fonctionnement. Veuillez consulter la notice d'installation des appareils intérieurs et vous assurer que les appareils fonctionnent correctement.
- Si vous soumettez simultanément tous les appareils à un essai de fonctionnement, il ne vous sera pas possible de détecter les éventuelles erreurs de raccordement des tuyaux de réfrigérant et de câblage des appareils intérieurs/extérieurs. Vous devez donc lancer les essais de fonctionnement l'un après l'autre.

### Concernant le mécanisme de protection contre une remise en marche trop rapide

Lorsque le compresseur s'arrête, le dispositif de protection contre la remise en marche à trop brève échéance s'enclenche. Le compresseur restera arrêté trois minutes avant de se remettre en marche, afin de protéger le climatiseur.

### Fonction de correction de câblage/tuyauterie

L'appareil est équipé d'une fonction qui permet de corriger les branchements de câblage et de tuyauterie. En cas de branchement incorrect de câblage et de tuyauterie ou de problème de vérification, utiliser cette fonction pour détecter et corriger le branchement en respectant la procédure suivante.

Vérifier que les étapes suivantes ont été effectuées.

- L'appareil est alimenté.
- Les vannes d'arrêt sont ouvertes.

### Remarque :

Lors de la détection, le fonctionnement de l'appareil intérieur est contrôlé par l'appareil extérieur. Lors de la détection, l'appareil intérieur s'arrête automatiquement. Il ne s'agit pas d'un dysfonctionnement.

### Procédure

Appuyez sur le commutateur de correction de tuyauterie/câblage (SW871) pendant 1 minute minimum après la mise sous tension de l'appareil.

- La correction s'effectue en 10 à 20 minutes. Une fois la correction terminée, le résultat est indiqué par un voyant DEL. Les détails sont décrits dans le tableau suivant.
- Pour annuler cette fonction en cours de fonctionnement, appuyer de nouveau sur le commutateur de correction de câblage/tuyauterie (SW871).
- Lorsque la correction est effectuée sans erreur, ne pas appuyer de nouveau sur le commutateur de correction de câblage/tuyauterie (SW871).

Lorsque le résultat est "non réalisé", appuyer de nouveau sur le commutateur de correction de câblage/tuyauterie (SW871) pour annuler cette fonction. Vérifier ensuite les raccordements de câblage et tuyauterie de manière conventionnelle en faisant fonctionner les appareils intérieurs l'un après l'autre.

- Pour utiliser cette fonction, l'appareil doit être alimenté. Veiller à ne pas toucher des éléments autres que le commutateur, notamment le panneau de commande. Cela peut entraîner un choc électrique ou des brûlures par des éléments chauds ou sous tension situés autour du commutateur. Le contact avec des éléments sous tension peut endommager le tableau de commande.
- Pour éviter les dommages électroniques du panneau de commande, veiller à éliminer l'électricité statique avant d'utiliser cette fonction.

- Cette fonction ne peut pas être utilisée lorsque la température extérieure est égale ou inférieure à 32°F (0°C).

### Voyant DEL lors de la détection:

DEL1 (Rouge)	DEL2 (Jaune)	DEL3 (Verte)
Allumé	Allumé	Une fois

### Résultat de la fonction de correction de câblage/tuyauterie

DEL1 (Rouge)	DEL2 (Jaune)	DEL3 (Verte)	Résultat
Allumé	Éteint	Allumé	Terminé (Problème corrigé ou situation normale)
Une fois	Une fois	Une fois	Non terminé (Échec de la détection)
Autres indications			Se reporter à l'étiquette "PRÉCAUTIONS DE SÉCURITÉ À SUIVRE LORSQUE LA DEL CLI- GNOTE" située au dos du panneau de service.

## 4-6. EXPLICATIONS DESTINÉES À L'UTILISATEUR

- A l'aide de la NOTICE D'UTILISATION, expliquez à l'utilisateur l'emploi du climatiseur (utilisation de la télécommande, remplacement des filtres à air, enlèvement ou placement de la télécommande sur son support, nettoyage, précautions à prendre pour le fonctionnement, etc.).
- Recommandez à l'utilisateur de lire attentivement la NOTICE D'UTILISATION.

## 5. PURGE

Lors du déplacement ou de la mise au rebut du climatiseur, il est nécessaire de purger le système en suivant la procédure ci-dessous de façon à ne pas libérer le réfrigérant dans l'atmosphère.

- 1) Coupez le disjoncteur.
- 2) Raccordez la vanne du collecteur à jauge à l'ouverture de service du robinet d'arrêt du côté du conduit de gaz de l'unité externe.
- 3) Fermez complètement le robinet d'arrêt du côté du conduit de liquide de l'unité externe.
- 4) Enclenchez le disjoncteur.
- 5) Démarrez le fonctionnement en mode COOL (REFROIDISSEMENT) sur tous les appareils intérieurs.
- 6) Lorsque le manomètre indique 0,1 à 0 psi [jauge] (0,05 à 0 MPa), fermez complètement le robinet d'arrêt du côté du tuyau de gaz de l'appareil extérieur et arrêtez le système. (Reportez-vous au manuel d'installation de l'appareil intérieur pour la méthode d'arrêt du système.)
  - \* Si trop de réfrigérant a été ajouté au système de climatisation, il se peut que la pression ne parvienne pas à baisser jusqu'à 0,1 à 0 psi (jauge) (0,05 à 0 MPa) ou la fonction de protection pourrait se déclencher en raison de la montée de pression dans le circuit de réfrigérant à haute pression. Dans ce cas, utilisez un dispositif de collecte du réfrigérant pour recueillir la totalité du réfrigérant du système, puis rechargez la quantité de réfrigérant correcte dans le système après avoir déplacé les unités internes et externes.
- 7) Coupez le disjoncteur. Retirez le manomètre et la tuyauterie du réfrigérant.

### AVERTISSEMENT

**Pendant l'opération d'aspiration du réfrigérant, arrêtez le compresseur avant de débrancher les tuyaux de réfrigérant. Le compresseur risque d'éclater et de provoquer des blessures si une substance étrangère, comme de l'air, pénètre dans les tuyaux.**

**ÍNDICE**

1. ANTES DE LA INSTALACIÓN.....	1
2. INSTALACIÓN DE LA UNIDAD EXTERIOR.....	4
3. TRABAJOS DE ABocardADO Y CONEXIÓN DE TUBERÍAS.....	5
4. PROCEDIMIENTOS DE PURGADO, PRUEBA DE FUGAS Y FUNCIONAMIENTO DE PRUEBA.....	5
5. BOMBEO DE VACIADO.....	7

**Herramientas necesarias para la instalación**

Destornillador Phillips	Abocardador para R410A
Nivel	Válvula colector de manómetro para R410A
Báscula	Bomba de vacío para R410A
Cuchilla o tijeras	Manguera de carga para R410A
Llave dinamométrica	Cortador de tuberías con escariador
Llave (o llave de tuercas)	
Llave hexagonal de 5/32 pulg. (4 mm)	

**1. ANTES DE LA INSTALACIÓN**

**1-1. POR RAZONES DE SEGURIDAD, DEBERÁ OBSERVARSE SIEMPRE LO SIGUIENTE**

- Antes de instalar el acondicionador de aire, lea atentamente el apartado "POR RAZONES DE SEGURIDAD, DEBERÁ OBSERVARSE SIEMPRE LO SIGUIENTE".
- Observe los mensajes de atención y cuidado indicados en él, ya que se refieren a cuestiones de seguridad importantes.
- Cuando haya acabado de leer el manual, no olvide dejarlo junto al MANUAL DE INSTRUCCIONES para su futura referencia.

**⚠ ATENCIÓN (Podría causar la muerte, lesiones graves, etc.)**

- **El usuario no debe instalar la unidad.**  
Una instalación defectuosa podría causar incendios, descargas eléctricas o lesiones debidos a una caída de la unidad o escapes de agua. Para hacer la instalación, consulte al concesionario en el que adquirió esta unidad o a un instalador cualificado.
- **Para efectuar una instalación segura, consulte el manual de instalación.**  
Una instalación defectuosa podría causar incendios, descargas eléctricas o lesiones debidos a una caída de la unidad o escapes de agua.
- **Al instalar la unidad, use equipos y herramientas de protección adecuadas para garantizar la seguridad.**  
De no hacerlo, podría sufrir daños corporales.
- **Asegúrese de que el lugar de instalación puede aguantar el peso de la unidad.**  
Si el lugar de instalación no puede aguantar el peso de la unidad, ésta podría caerse y causar daños.
- **Realice la instalación eléctrica siguiendo las instrucciones del manual de instalación y asegurándose de emplear un circuito exclusivo. No conecte otros dispositivos eléctricos al circuito.**  
Si el circuito de alimentación no tiene suficiente capacidad o la instalación eléctrica es insuficiente, podría producirse un incendio o una descarga eléctrica.
- **Evite dañar los cables aplicando una presión excesiva con las piezas o tornillos.**  
Unos cables dañados podrían provocar incendios.
- **Asegúrese de desconectar el conmutador de alimentación general al instalar la placa de circuito impreso o manipular los cables de conexión.**  
De no hacerlo, podría provocar una descarga eléctrica.
- **Utilice los cables indicados para instalar de forma segura las unidades interior y exterior y conecte bien los cables en las secciones de conexión del panel de terminales de modo que no queden tensos en dichas secciones.**  
Una conexión y fijación defectuosas podrían provocar un incendio.
- **No instale la unidad en un lugar donde haya fugas de gas inflamable.**  
Si hay fugas de gas y se acumula en la zona que rodea la unidad, podría producirse una explosión.
- **No emplee conexiones intermedias del cable de alimentación ni tampoco un cable de extensión; evite también conectar demasiados aparatos a una sola toma de CA.**  
Esto podría provocar un incendio o una descarga eléctrica a causa de un contacto o un aislamiento defectuoso, un exceso de corriente, etc.
- **Procure utilizar las piezas suministradas o indicadas para efectuar la instalación.**  
El empleo de piezas defectuosas podría provocar lesiones o escapes de agua a causa de un incendio, una descarga eléctrica, la caída de la unidad, etc.
- **Al conectar el enchufe de alimentación en la toma, asegúrese de que no hay polvo, obstrucciones o piezas sueltas ni en la toma ni en el enchufe. Asegúrese de que el enchufe de alimentación está completamente insertado en la toma.**  
Si hay polvo, obstrucciones o piezas sueltas en el enchufe de alimentación o la toma, podría provocar incendios o descargas eléctricas. Si el enchufe de alimentación presenta piezas sueltas, sustitúyalo.
- **Fije firmemente la cubierta de la instalación eléctrica a la unidad interior y el panel de servicio, a la unidad exterior.**  
Si no se fijan con firmeza la cubierta eléctrica de la unidad interior y el panel de servicio de la unidad exterior, podría producirse un incendio o una descarga eléctrica a causa del polvo, el agua, etc.
- **Al instalar, reubicar o reparar la unidad, asegúrese de que en el circuito de refrigeración no entra ninguna otra sustancia que no sea el refrigerante especificado (R410A).**  
La presencia de cualquier otra sustancia extraña, como aire por ejemplo, puede provocar una elevación anómala de la presión, una explosión o daños corporales. El uso de un refrigerante distinto al especificado por el sistema ocasionará fallos mecánicos, malfuncionamiento del sistema o averías en la unidad. En el peor de los casos, esto podría llegar a ser un serio impedimento para garantizar el uso seguro del producto.
- **No descargue el refrigerante en el ambiente. Si se producen fugas de refrigerante durante la instalación, ventile la habitación.**  
Si el refrigerante entra en contacto con una llama, podría generarse gas nocivo. La pérdida de refrigerante puede provocar asfixia. Ventile la habitación.
- **Una vez acabada la instalación, compruebe que no haya fugas de gas refrigerante.**  
Si se produjeran pérdidas de gas refrigerante en un interior y entraran en contacto con la llama de un calefactor con ventilador, un calentador, una estufa, etc. se generarían sustancias nocivas.
- **Utilice las herramientas apropiadas y los materiales de conducción adecuados para la instalación.**  
La presión del refrigerante R410A es 1,6 veces mayor que la del R22. Si no se utilizan herramientas o materiales apropiados, o si se realiza una instalación defectuosa, las tuberías podrían estallar o sufrir daños.
- **Al bombear el refrigerante, detenga el compresor antes de desconectar las tuberías de refrigerante.**  
Si las tuberías de refrigerante se desconectan con el compresor en marcha y la válvula de retención está abierta, podría entrar aire y la presión del ciclo de refrigeración aumentaría de forma anómala. Esto podría hacer que las tuberías estallaran o sufrieran daños.
- **Al instalar la unidad, conecte las tuberías de refrigerante de forma fija antes de poner en marcha el compresor.**  
Si el compresor se pone en marcha antes de que las tuberías de refrigerante estén conectadas y la válvula de retención se abra, podría entrar aire y la presión del ciclo de refrigeración aumentaría de forma anómala. Esto podría hacer que las tuberías estallaran o sufrieran daños.
- **Apriete la tuerca abocardada con una llave dinamométrica tal y como se especifica en el presente manual.**  
Si la aprieta demasiado, la tuerca abocardada podría romperse transcurrido un tiempo, causando pérdidas de refrigerante.
- **Instale la unidad de acuerdo con la normativa para instalaciones eléctricas.**
- **Conecte a tierra la unidad.**  
No conecte el cable de tierra a una tubería de gas, de agua o al cable de tierra de un teléfono. Una conexión defectuosa podría provocar una descarga eléctrica.
- **Asegúrese de instalar un disyuntor del Interruptor de fallo de conexión a tierra (GFI).**  
De no instalar un disyuntor del Interruptor de fallo de conexión a tierra (GFI) se podría producir una descarga eléctrica o incendio.

**⚠ CUIDADO (Podría causar lesiones graves en ciertos entornos si se manipula incorrectamente.)**

- **Para efectuar un drenaje y una instalación de tuberías seguros, siga las indicaciones del manual de instalación.**  
Un drenaje o una instalación de tuberías defectuosos podría causar un escape de agua en la unidad que mojaría y estropearía los enseres del hogar.
- **No toque la entrada de aire ni las aletas de aluminio de la unidad exterior.**  
Esto podría causar lesiones.
- **No instale la unidad exterior donde puedan vivir animales pequeños.**  
Si los animales penetran en la unidad y tocan las piezas eléctricas podrían provocar fallos de funcionamiento, humos o incendios. Además, aconseje a los usuarios que mantengan limpia la área alrededor de la unidad.

**1-2. ESPECIFICACIONES**

Modelo	Alimentación		Longitud de tubería y diferencia de altura *1, *2, *3, *4, *5, *6			
	Tensión de régimen	Frecuencia	Longitud máxima del tubo por unidad interior / para sistema múltiple	Diferencia máxima de altura	Nº máx. de codos por unidad interior / para sistema múltiple	Ajuste de refrigerante A *7
MXZ-3C24NA2 MXZ-3C30NA2 MXZ-4C36NA2	208 / 230 V	60 Hz	82 pies (25 m) / 230 pies (70 m)	49 pies (15 m)	25 / 70	1,08 onzas por cada 5 pies (20 g/m)

\*1 Nunca utilice tuberías de grosor menor que el especificado. La resistencia a la presión sería insuficiente.  
 \*2 Utilice una tubería de cobre o una tubería de aleación de cobre sin costuras.  
 \*3 Tenga cuidado de no romper o doblar la tubería cuando la flexione.  
 \*4 El radio de curvatura de la tubería de refrigerante debe ser de 4 pulg. (100 mm) o más.  
 \*5 Material aislante: Plástico de espuma termostensible con un peso específico de 0,045  
 \*6 Asegúrese de utilizar un aislamiento de grosor especificado. Un grosor excesivo puede alterar la correcta instalación de la unidad interior y un grosor insuficiente puede generar goteo de rocío.

\*7 Si la longitud de la tubería es superior a 98 pies (30 m) será necesario emplear más refrigerante (R410A). (Si la longitud de la tubería es inferior a 98 pies (30 m), no es necesario más refrigerante).  
 Refrigerante adicional (pies) = A × ((longitud de la tubería (pies) - 98) / 5)  
 Refrigerante adicional (m) = A × ((longitud de la tubería (m) - 30) / 5)



### 1-3. SELECCIÓN DE LAS JUNTAS PARA DISTINTOS DIÁMETROS OPCIONALES

Si el diámetro del tubo de conexión no coincide con el tamaño de puerto de la unidad exterior, utilice las juntas para distintos diámetros opcionales de acuerdo con la siguiente tabla.

(Unidad: pulg. (mm))

Tamaño de puerto de la unidad exterior			Juntas para distintos diámetros opcionales (tamaño de puerto de la unidad exterior → diámetro del tubo de conexión)
MXZ-3C	MXZ-4C	Líquido/gas	1/4 (6,35) → 3/8 (9,52) : PAC-493PI 3/8 (9,52) → 1/2 (12,7) : MAC-454JP-E 3/8 (9,52) → 5/8 (15,88) : PAC-SG76RJ-E 1/2 (12,7) → 3/8 (9,52) : MAC-A455JP-E 1/2 (12,7) → 5/8 (15,88) : MAC-A456JP-E
UNIDAD A		1/4 (6,35) / 1/2 (12,7)	Consulte en el manual de instalación de la unidad interior el diámetro del tubo de conexión de la unidad interior.
UNIDAD B - C	UNIDAD B - D	1/4 (6,35) / 3/8 (9,52)	

### 1-4. SELECCIÓN DEL LUGAR DE INSTALACIÓN

- Donde no esté expuesta a un viento fuerte.
- Donde haya un buen flujo de aire sin polvo.
- Donde se pueda evitar todo lo posible la lluvia o la luz directa del sol.
- Donde el ruido o el aire caliente causados por el funcionamiento no moleste a los vecinos.
- Donde haya una pared o un punto de apoyo firme para evitar un mayor ruido o vibración durante el funcionamiento.
- Donde no exista riesgo de fugas de gas combustible.
- Asegúrese de fijar las patas de la unidad a la hora de instalarla.
- Donde esté a una distancia mínima de 10 pies (3 m) de cualquier antena de televisión o radio. En las zonas con mala recepción, el funcionamiento del aparato de aire acondicionado puede provocar interferencias en estos aparatos. Puede ser necesario conectar el receptor afectado a un amplificador.
- Instale la unidad en horizontal.
- Instálela en un área donde no sufra el efecto provocado por una nevada, viento o nieve. En zonas de intensa nieve, le rogamos que instale un toldo, pedestal y/o algunas pantallas acústicas planas.

#### Nota:

Se recomienda establecer el circuito cerrado de la tubería cerca de la unidad exterior para reducir la vibración que pudiera transmitirse desde ese punto.

#### Nota:

Si utiliza el acondicionador de aire cuando la temperatura exterior sea baja, observe las instrucciones siguientes.

- No instale nunca la unidad exterior en un lugar en el que el lado de entrada/salida de aire quede expuesto directamente al viento.
- Para evitar la exposición al viento, instale la unidad exterior con el lado de entrada de aire hacia la pared.
- Para evitar la exposición al viento, se recomienda instalar una placa deflector en el lado de salida de aire de la unidad exterior.

Para instalar el aparato de aire acondicionado, evite los lugares siguientes donde es más probable que ocurran problemas.

- Donde pueda haber una fuga de gas inflamable.
- Donde haya demasiado aceite para maquinaria.
- En ambientes salobres, como las zonas costeras.
- Donde haya gas sulfúrico, como en zonas de baños termales.
- Donde haya algún equipo inalámbrico o de alta frecuencia.
- Donde haya elevadas emisiones de COV, incluidos compuestos de ftalato, aldehído fórmico, etc., que puedan causar craqueos.

## ESPACIO LIBRE NECESARIO EN TORNO A LA UNIDAD EXTERIOR

### 1. Obstáculos sobre la unidad

Si no hay obstáculos por la parte delantera ni en los lados, es posible instalar la unidad si hay algún obstáculo por encima de la unidad siempre que haya el espacio que se muestra en la figura.

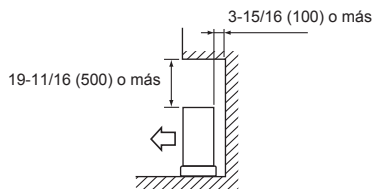

### 3. Obstáculos solamente por la parte frontal (ventilación)

Si hay un obstáculo por la parte frontal de la unidad como se muestra en la ilustración, ambos lados, la parte superior y la parte trasera deben quedar libres.

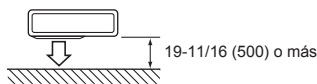

### 2. Parte frontal (ventilación) abierta

Siempre que se mantenga libre un espacio como el que se muestra en la ilustración, no importa que haya obstáculos detrás y a los lados de la unidad. (Sin obstáculo sobre la unidad)

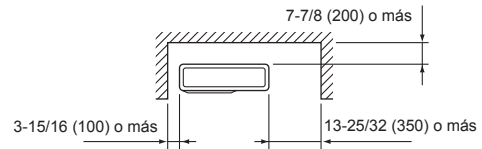

### 4. Obstáculos en la parte delantera y trasera

La unidad se puede utilizar si se agrega una guía de ventilación exterior opcional (PAC-SH96SG-E) (si ambos lados y la parte superior están libres).

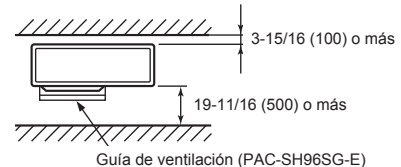

### 5. Obstáculos por la parte frontal, trasera y en los lados

- Si la unidad se instala en un área encerrada entre paredes, como una galería, asegúrese de dejar espacio suficiente tal y como se muestra a continuación. En este caso, la capacidad de acondicionamiento de aire y el consumo eléctrico pueden empeorar.
- Si se instalan dos o más unidades, no deben instalarse una frente a la otra ni una detrás de la otra.

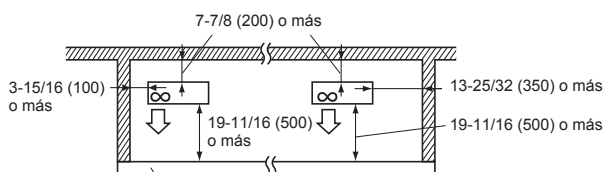

La altura del obstáculo es 47-1/4 (1200) o menos

### 6. Espacio de servicio

Mantenga el espacio de servicio y mantenimiento que se muestra en la siguiente figura.

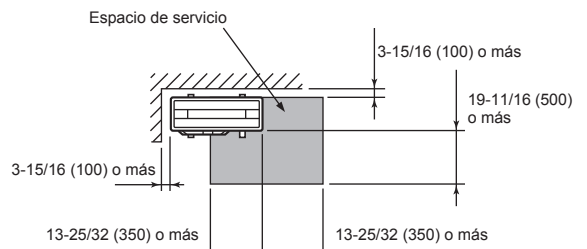

(Unidad: pulg. (mm))

# 1-5. DIAGRAMA DE INSTALACIÓN

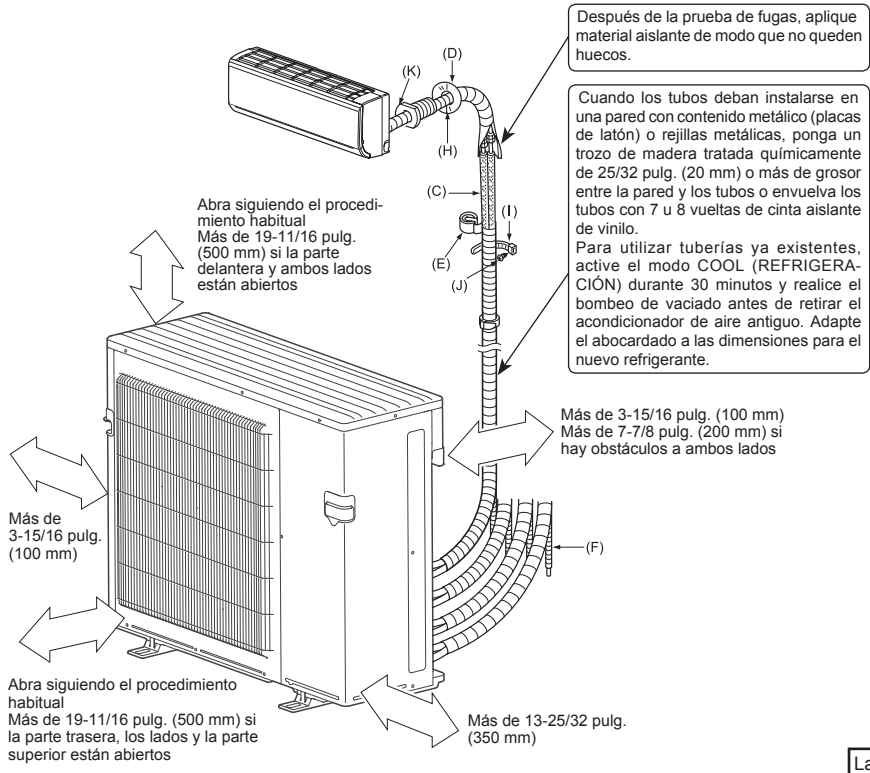

## COMPONENTES QUE DEBERÁ ADQUIRIR LOCALMENTE

(A)	Cable de alimentación*	1
(B)	Cable de conexión interior/externo*	1
(C)	Tubo de conexión	1
(D)	Cubierta del orificio de la pared	1
(E)	Cinta para las conexiones	1
(F)	Prolongación del tubo de drenaje (tubería de PVC blando de 19/32 pulg. (15 mm) en el interior o tubería VP16 de PVC duro)	1
(G)	Aceite refrigerante	Poca cantidad
(H)	Masilla	1
(I)	Banda de fijación del tubo	2 a 7
(J)	Tornillo de fijación para (I)	2 a 7
(K)	Manguito del orificio de la pared	1
(L)	Manguera de PVC blando de 19/32 pulg. (15 mm) en el interior o tubería VP16 de PVC duro para tapa de desagüe (1)	1

**\* Nota:**  
Tienda el cable de conexión de la unidad interior/externo (B) y el cable de alimentación (A) al menos a 3 pies (1 m) de distancia del cable de la antena de televisión.

Las "cantidades" referenciadas (B) y (K) indican el n° de componentes que deberá utilizar por unidad interior.

La unidad debe ser instalada por el servicio oficial de acuerdo con la normativa local.

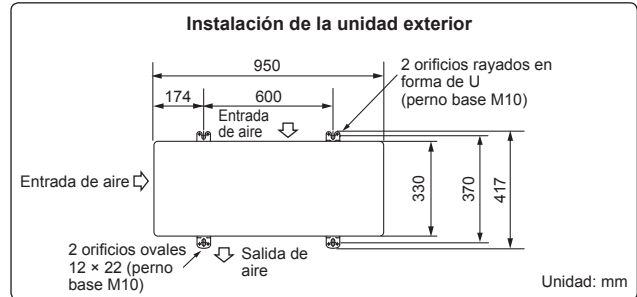
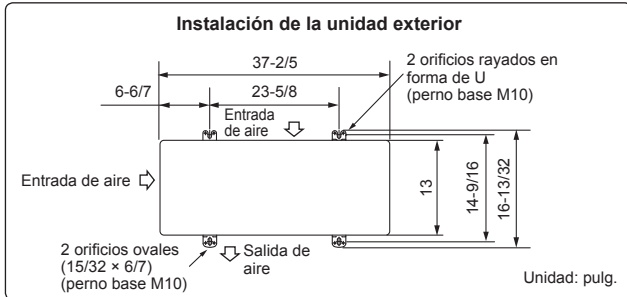

## 2. INSTALACIÓN DE LA UNIDAD EXTERIOR

### 2-1. INSTALACIÓN DE LA UNIDAD

- Asegúrese de fijar los pies de la unidad con tornillos cuando la instale.
- Asegúrese de instalar firmemente la unidad para evitar su desprendimiento en caso de terremoto o ráfaga de viento.
- Con respecto a la cimentación de hormigón, refiérase a la figura de la derecha.
- No utilice la boquilla de drenaje ni los taponés en una zona fría. La boquilla podría congelarse y el ventilador podría pararse.

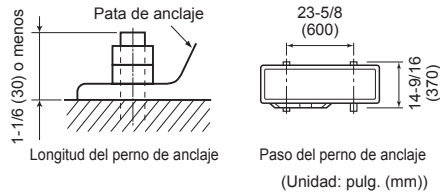
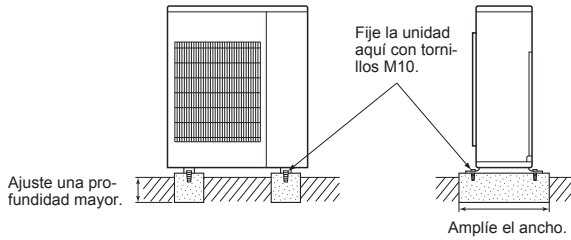

### 2-2. CABLES DE CONEXIÓN PARA LA UNIDAD EXTERIOR

- Asegúrese de utilizar circuitos específicos para el aire acondicionado de la sala.
- Los trabajos de cableado se deben basar en los estándares técnicos aplicables.
- Las conexiones de cableado deben realizarse según el siguiente diagrama.
- Los tornillos deben apretarse de forma que no se suelten.

ESPECIFICACIONES ELÉCTRICAS			
UNIDAD EXTERIOR	MXZ-3C24NA2	MXZ-3C30NA2	MXZ-4C36NA2
Alimentación (V, FASE, Hz)	208/230, 1, 60		
Tamaño máx. fusible (retardo) (A)	25		
Amperaje mín. del circuito (A)	22,1		23,1
Motor del ventilador (F.L.A)	2,43		2,43
Compresor	(R.L.A)	12	12
	(L.R.A)	13,7	13,7
Tensión de control	Unidad interior-controlador remoto: (inalámbrico) Unidad interior-unidad exterior: 12-24 V CC		

- 1) Extraiga el panel de servicio.
- 2) Extraiga la placa de conducción.
- 3) Acople el conector de conducción a la placa de conducción con la tuerca de bloqueo y, a continuación, fíjelo a la unidad con tornillos.
- 4) Conecte los cables de tierra a la fijación TB.
- 5) Afloje el tornillo del terminal y conecte correctamente el cable de conexión de la unidad interior/exterior (B) desde la unidad interior en el bloque de terminales. Procure no equivocarse al hacer las conexiones. Fije con firmeza el cable al bloque de terminales de modo que no quede a la vista ninguna parte del alma, y que no se aplique ninguna fuerza externa a la sección de conexión del bloque de terminales.
- 6) Apriete bien los tornillos de los terminales para que no se aflojen. Una vez apretados, tire ligeramente de los cables para confirmar que no se mueven.
- 7) Siga los pasos 5) y 6) para cada unidad interior.
- 8) Conecte el cable de alimentación (A).
- 9) Cierre firmemente el panel de servicio. Asegúrese de que 3-2. CONEXIÓN DE TUBERÍAS ha terminado.

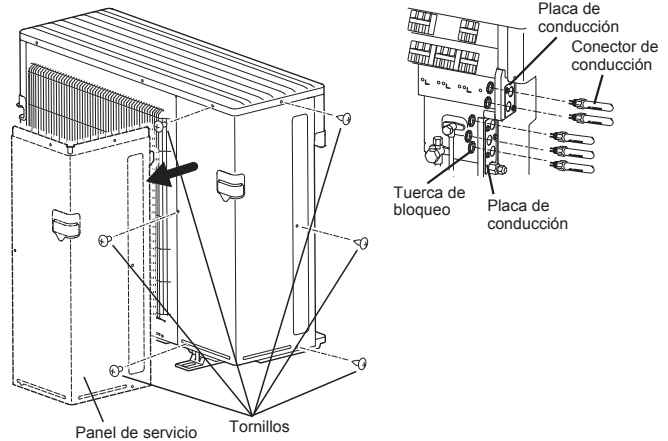

#### Orden de conexión

- Conecte el panel de terminales en el orden siguiente.  
A → B → C → D → P  
La unidad D es para 4C36NA2 solamente

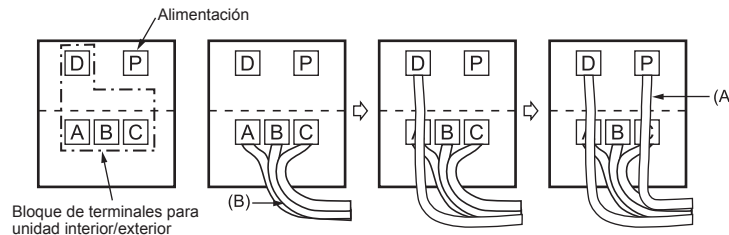

#### Observación:

- \* Se debe exigir un interruptor de desconexión. Consulte la normativa local.
- \*\* Utilice un terminal en anillo para conectar el cable de tierra al terminal.

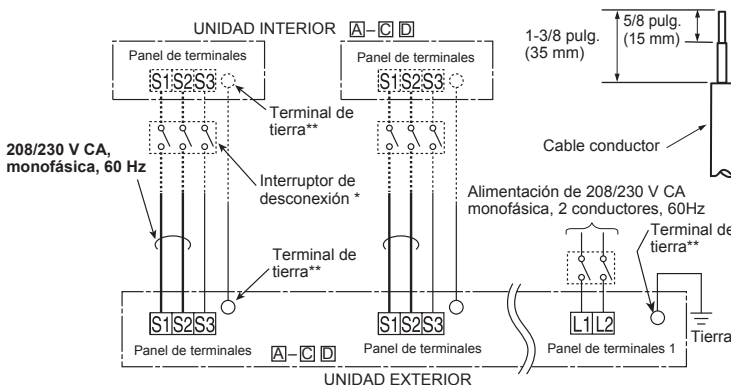

La unidad D es para 4C36NA2 solamente

- Conecte los cables al número correspondiente de terminales.
- Asegúrese de conectar cada tornillo con su terminal correspondiente cuando fije los cables al panel de terminales.

#### CONEXIÓN DE CABLES Y CONEXIÓN DEL CABLE DE TIERRA

- Utilice un conductor sólido con un calibre mín. AWG14 o un conductor trenzado con un calibre mín. AWG14.
- Use un cable con aislamiento doble, aislamiento de 600 V.
- Use únicamente conductores de cobre.
- \* Siga la normativa eléctrica local.

#### CABLE DE ALIMENTACIÓN Y CABLE DE TIERRA

- Utilice un conductor sólido o trenzado con un calibre mín. AWG12.
- Use únicamente conductores de cobre.
- \* Siga la normativa eléctrica local.

#### ⚠ ATENCIÓN:

Conecte las unidades interior y exterior con el cable de conexión normalizado a este fin y sujete bien el cable al panel de terminales de modo que no quede tenso en la zona de conexiones del panel. Una conexión y fijación defectuosas podrían provocar un incendio.

Con vistas a un futuro mantenimiento, prolongue los cables de conexión.

## 3. TRABAJOS DE ABOCARDADO Y CONEXIÓN DE TUBERÍAS

### 3-1. TAREAS DE ABOCARDAMIENTO

- Corte el tubo de cobre correctamente con un cortador de tubos. (Fig. 1, 2)
- Elimine completamente las rebabas del corte transversal del tubo. (Fig. 3)
  - Orienta la tubería de cobre hacia abajo para evitar que las rebabas caigan dentro de la misma.
- Una vez eliminadas las rebabas, extraiga las tuercas abocardadas colocadas en las unidades interior y exterior y póngalas en el tubo. (Cuando se ha terminado el proceso de abocardado ya no se pueden poner).
- Labores de abocardamiento (Fig. 4, 5). Sujete firmemente el tubo de cobre de la dimensión que se muestra en la tabla. Seleccione la medida A en la tabla de acuerdo con la herramienta seleccionada.
- Compruebe
  - Compare el abocardado con la Fig. 6.
  - Si el abocardado se ve defectuoso, corte la sección abocardada y repita el proceso de abocardado.

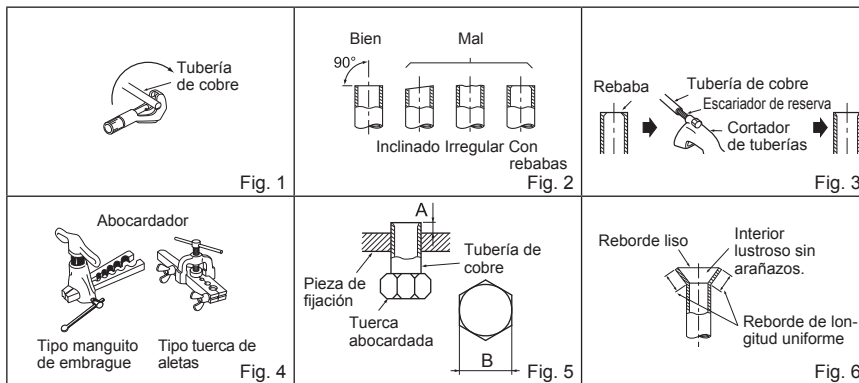

Diámetro del tubo [pulg. (mm)]	B [pulg. (mm)]	A [pulg. (mm)]			Par de torsión		
		Herramienta tipo embrague para R410A	Herramienta tipo embrague para R22	Herramienta tipo tuerca de mariposa para R22	pies•lb	N•m	kgf•cm
1/4 (ø6,35)	21/32 (17)	0 a 0,02 (0 a 0,5)	0,04 a 0,06 (1,0 a 1,5)	0,06 a 0,08 (1,5 a 2,0)	10 a 13	13,7 a 17,7	140 a 180
3/8 (ø9,52)	7/8 (22)			0,08 a 1,0 (2,0 a 2,5)	25 a 30	34,3 a 41,2	350 a 420
1/2 (ø12,7)	1-1/32 (26)				36 a 42	49,0 a 56,4	500 a 575
5/8 (ø15,88)	1-5/32 (29)				54 a 58	73,5 a 78,4	750 a 800

### 3-2. CONEXIÓN DE TUBERÍAS

- Aplique una capa fina de aceite refrigerante (G) a los extremos abocardados de las conexiones de la tubería de la unidad exterior.
- Alinee el centro de la tubería con el centro de las conexiones de la tubería de la unidad exterior y apriete a mano las primeras 3 o 4 vueltas de la tuerca abocardada.
- Apriete la tuerca abocardada con una llave dinamométrica tal y como se especifica en la tabla.
  - Si la aprieta demasiado podría dañarse la tuerca abocardada, causando pérdidas de refrigerante.
  - No olvide envolver las tuberías con cinta aislante. El contacto directo con la tubería descubierta podría causar quemaduras o congelación.

**ATENCIÓN**  
Al instalar la unidad, conecte las tuberías de refrigerante de forma fija antes de poner en marcha el compresor.

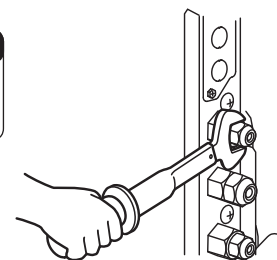

### 3-3. AISLAMIENTO TÉRMICO Y FORRADO CON CINTA

- Cubra las uniones de tuberías con cubiertas de tubería.
- En el lado de la unidad exterior, aisle bien cada una de las tuberías y válvulas.
- Aplique cinta de tuberías (E) a partir de la entrada de la unidad exterior.
  - Sujete con cinta (adhesiva) el extremo de la cinta de tuberías (E).
  - Cuando las tuberías deban colocarse por encima del techo, en un armario empotrado o en lugares con una temperatura y humedad elevadas, tendrá que aplicar una cantidad suplementaria de aislante para evitar la condensación.

**CUIDADO**  
Si quedan puertos sin utilizar, asegúrese de apretar firmemente sus tuercas.

## 4. PROCEDIMIENTOS DE PURGADO, PRUEBA DE FUGAS Y FUNCIONAMIENTO DE PRUEBA

### 4-1. PROCEDIMIENTO DE PURGADO Y PRUEBA DE FUGAS

- Retire la tapa de la abertura de servicio de la válvula de retención situada en el lado de la tubería de gas de la unidad exterior. (Inicialmente, las válvulas de retención están completamente cerradas y cubiertas con sus tapas).
- Conecte la válvula colectora de manómetro y la bomba de vacío al puerto de servicio de la válvula de retención en el lado de la tubería del gas de la unidad exterior.
- Ponga en funcionamiento la bomba de vacío. (Déjela funcionar durante más de 15 minutos).
- Compruebe el vacío con la válvula colectora de manómetro, cierre luego esta válvula y detenga la bomba de vacío.
- Espere así uno o dos minutos. Asegúrese de que el indicador de la válvula colectora de manómetro permanece en la misma posición. Compruebe que el manómetro de presión marca -14,7 psi [manómetro] (-0,101 MPa).
- Extraiga rápidamente la válvula colectora de manómetro del puerto de servicio de la válvula de retención.
- Abra por completo todas las válvulas de retención de la tubería de gas y de la tubería de líquido. Si no se lleva a cabo esta operación abriendo dichas válvulas por completo, el rendimiento disminuirá y se producirán problemas.
- Consulte 1-2., e introduzca la cantidad indicada de refrigerante si fuera necesario. Introduzca el refrigerante líquido con lentitud. De lo contrario, la composición del refrigerante en el sistema puede cambiar y afectar al rendimiento del equipo de aire acondicionado.
- Apriete la tapa del puerto de servicio para volver al estado inicial.
- Prueba de fugas

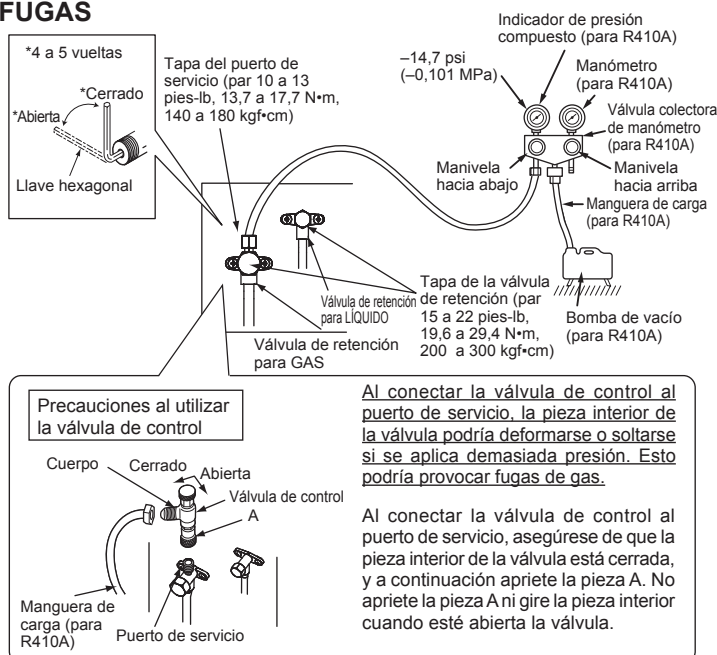

## 4-2. CARGA DE GAS

Efectúe la carga de gas en la unidad.

- 1) Conecte el cilindro de gas a la abertura de servicio de la válvula de retención.
- 2) Purgue el aire de la tubería (o manguera) procedente del cilindro del refrigerante.
- 3) Añada la cantidad de refrigerante indicada mientras el equipo de aire acondicionado funciona en modo de refrigeración.

### Nota:

Si añade refrigerante, no sobrepase la cantidad especificada para el ciclo de refrigeración.

### CUIDADO:

Al añadir más refrigerante al sistema, asegúrese de utilizar refrigerante en estado líquido. Recuerde que si carga el refrigerante en estado gaseoso, su composición puede alterarse en el sistema y afectar a la operación normal del acondicionador del aire. Recuerde también cargar el refrigerante líquido poco a poco, ya que de lo contrario puede bloquear el compresor. Para mantener alta la presión del cilindro de gas, caliente el cilindro de gas con agua caliente (a menos de 104°F (40°C)) en las estaciones frías. Nunca utilice fuego o vapor.

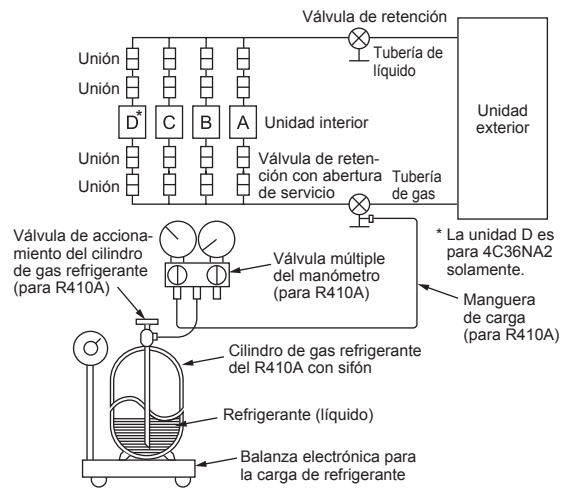

## 4-3. BLOQUEAR EL MODO DE FUNCIONAMIENTO DEL AIRE ACONDICIONADO (COOL (REFRIGERACIÓN), DRY (DESHUMIDIFICACIÓN), HEAT (CALEFACCIÓN))

### Descripción de la función:

Con esta función, una vez que el modo de funcionamiento se ha bloqueado en COOL/DRY (REFRIGERACIÓN/DESHUMIDIFICACIÓN) o HEAT (CALEFACCIÓN), el acondicionador de aire funciona únicamente en ese modo.

- \* Es necesario cambiar el ajuste para activar esta función. Explique esta función a sus clientes y pregúnteles si desean usarla.

### [Cómo bloquear el modo de funcionamiento]

- 1) Asegúrese de apagar el acondicionador de aire antes de realizar este ajuste.
- 2) Ajuste el interruptor "3" de SW1 en el panel del controlador exterior en la posición ON para habilitar esta función.
- 3) Para bloquear el funcionamiento en el modo COOL/DRY (REFRIGERACIÓN/DESHUMIDIFICACIÓN), ajuste el interruptor "4" de SW1 en el panel del controlador exterior en la posición OFF. Para bloquear el funcionamiento en el modo HEAT, ajuste el mismo interruptor en la posición ON.
- 4) Encienda el acondicionador de aire.

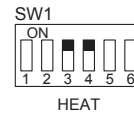
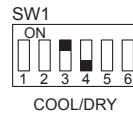
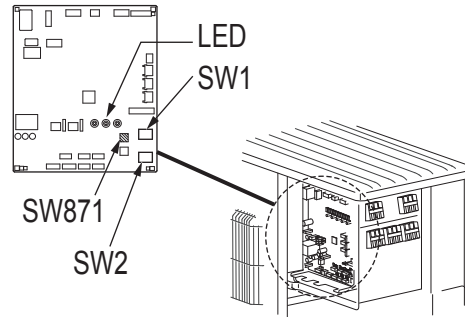

## 4-4. REDUCIR EL RUIDO DE FUNCIONAMIENTO DE LA UNIDAD EXTERIOR

### Descripción de la función:

Con esta función, que reduce la carga de funcionamiento, puede limitarse el ruido de la unidad exterior durante la noche en modo COOL (REFRIGERACIÓN). Sin embargo, tenga en cuenta que la capacidad de refrigeración y calefacción puede reducirse al activar esta función.

- \* Es necesario cambiar el ajuste para activar esta función. Explique esta función a sus clientes y pregúnteles si desean usarla.

### [Cómo reducir el ruido de funcionamiento]

- 1) Asegúrese de apagar el acondicionador de aire antes de realizar este ajuste.
- 2) Ajuste el interruptor "5" de SW1 en el panel del controlador exterior en la posición ON para habilitar esta función.
- 3) Encienda el acondicionador de aire.



Reducir el ruido de funcionamiento

#### 4-5. COMPROBACIÓN DE FUNCIONAMIENTO

- Deben realizarse pruebas de funcionamiento de las unidades interiores de forma individual. Consulte el manual de instalación que acompaña a la unidad interior y asegúrese de que todas las unidades funcionan correctamente.
- Si se realiza la prueba de funcionamiento de todas las unidades al mismo tiempo, no podrán detectarse posibles conexiones erróneas de las tuberías de refrigerante ni de los cables que conectan las unidades interiores y la exterior. Por lo tanto, asegúrese de realizar la prueba de funcionamiento de las unidades una a una.

##### Acerca del mecanismo de protección de la reanudación

Una vez se haya detenido el compresor, el dispositivo de prevención de la reanudación se activa de forma que el compresor no vuelve a ponerse en funcionamiento durante 3 minutos para proteger el acondicionador de aire.

##### Función de corrección de conexiones/tuberías

Esta unidad tiene una función de corrección de conexiones/tuberías que corrige la combinación de las mismas. Cuando exista la posibilidad de una combinación de conexiones y tuberías incorrecta y resulte difícil confirmarla, use esta función para detectarla y corregirla siguiendo estos procedimientos.

Asegúrese de lo siguiente.

- La unidad recibe corriente.
- Las válvulas de retención están abiertas.

##### Nota:

Durante la detección, el funcionamiento de la unidad interior estará controlado por la unidad exterior. Durante la detección, la unidad interior dejará de funcionar automáticamente. Esto no es un fallo de funcionamiento.

##### Procedimiento

Mantenga presionado el interruptor de corrección de tuberías/conexiones (SW871) 1 minuto o más tras conectar la alimentación.

- La corrección tarda entre 10 y 20 minutos en efectuarse. Cuando la corrección ha finalizado, su resultado se muestra por medio de indicadores luminosos. La tabla siguiente describe los detalles.
- Para cancelar esta función antes de que finalice, vuelva a pulsar el interruptor de corrección de tuberías/conexiones (SW871).
- Cuando la corrección finalice sin error, no vuelva a pulsar el interruptor de corrección de tuberías/conexiones (SW871).

Cuando el resultado sea "No completado", vuelva a pulsar el interruptor de corrección de tuberías/conexiones (SW871) para cancelar esta función. Seguidamente, confirme la combinación de conexiones y tuberías de la forma habitual, haciendo funcionar las unidades interiores una a una.

- Mientras la operación se lleva a cabo, la unidad recibe corriente. Asegúrese de no tocar nada más que el interruptor; tampoco la placa de circuito impreso. Podría sufrir una descarga eléctrica o quemaduras de las partes que reciben corriente o que están calientes en torno al interruptor. Si toca las partes que reciben corriente, puede dañar la placa de circuito impreso.
- Para evitar dañar la placa de circuito impreso de control electrónico, elimine la electricidad estática antes de utilizar esta función.

• Esta función no se puede utilizar cuando la temperatura en el exterior es de 32°F (0°C) o menos.

##### Indicadores luminosos durante la detección:

LED1 (Rojo)	LED2 (Amarillo)	LED3 (Verde)
Iluminado	Iluminado	Parpadea una vez

##### Resultado de la función de corrección de tuberías/conexiones

LED1 (Rojo)	LED2 (Amarillo)	LED3 (Verde)	Resultado
Iluminado	Apagado	Iluminado	Completado (Problema corregido o normal)
Parpadea una vez	Parpadea una vez	Parpadea una vez	No completado (No se ha detectado)
Otras indicaciones			Consulte las "PRECAUCIONES DE SEGURIDAD CUANDO EL INDICADOR PARPADEA", situadas detrás del panel de servicio.

#### 4-6. EXPLICACIÓN PARA EL USUARIO

- Basándose en el MANUAL DE INSTRUCCIONES, explique al usuario cómo utilizar el equipo de aire acondicionado (cómo utilizar el controlador remoto, cómo retirar los filtros de aire, cómo retirar o colocar el control remoto en el soporte para el controlador remoto, cómo limpiar, precauciones para el funcionamiento, etc.).
- Aconseje al usuario que lea atentamente el MANUAL DE INSTRUCCIONES.

### 5. BOMBEO DE VACIADO

Cuando traslade o se deshaga del aire acondicionado, bombee para vaciar el sistema siguiendo el procedimiento indicado a continuación para que no escape nada de refrigerante a la atmósfera.

- 1) Desactive el disyuntor.
- 2) Conecte la válvula colectora de manómetro al puerto de servicio de la válvula de retención en el lado de la tubería del gas de la unidad exterior.
- 3) Cierre completamente la válvula de retención en el lado de la tubería de líquido de la unidad exterior.
- 4) Active el disyuntor.
- 5) Inicie el funcionamiento de REFRIGERACIÓN de emergencia en todas las unidades interiores.
- 6) Cuando el medidor de presión indique de 0,1 a 0 psi [manómetro] (de 0,05 a 0 MPa), cierre completamente la válvula de retención en el lateral del tubo de gas de la unidad exterior y detenga la operación. (Consulte el manual de instalación de la unidad interior para más detalles acerca del método de detención de la operación).
  - \* Si se ha añadido demasiado refrigerante al sistema con acondicionador de aire, puede que la presión no baje de 0,1 a 0 psi [manómetro] (de 0,05 a 0 MPa), o que la función de protección se ponga en funcionamiento debido a la subida de presión en el circuito de refrigeración de presión elevada. Si esto ocurre, utilice el recogedor de refrigerante para recoger todo el refrigerante del sistema y, a continuación, una vez que las unidades interior y exterior se hayan reubicado, vuelva a recargar el sistema con la cantidad adecuada de refrigerante.
- 7) Desactive el disyuntor. Retire el medidor de presión y las tuberías de refrigerante.

#### **⚠ ATENCIÓN**

**Al bombear el refrigerante, detenga el compresor antes de desconectar las tuberías de refrigerante. El compresor podría explotar y causar lesiones si penetrara alguna sustancia extraña, como por ejemplo aire, en las tuberías.**



# **mitsubishi electric corporation**

HEAD OFFICE: TOKYO BLDG., 2-7-3, MARUNOUCHI, CHIYODA-KU, TOKYO 100-8310, JAPAN

WG79A686H01





### Photo

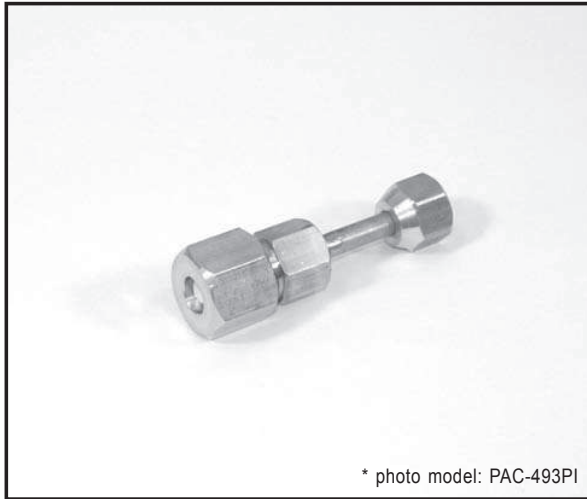

\* photo model: PAC-493PI

### Descriptions

A part to connect refrigerant pipes of the different diameter.  
(Unit  $\phi 9.52 \rightarrow \phi 12.7$ )

### Applicable Models

- MXZ-3A54VA    ■ MXZ-5A100VA    ■ PAC-AK50BC
- MXZ-4A71VA    ■ MXZ-8A140VA
- MXZ-4A80VA    ■ PAC-AK30BC

### Specifications

Pipe diameter	$\phi 9.52$
Pipe material	C 1220T - OL

### Dimensions

Unit : mm (inch)

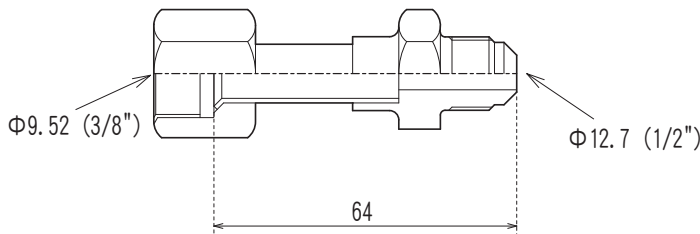

### How to Use / How to Install

**Make sure that you have all the following parts, in addition to this manual in this box:**

- Joint Pipe
- PAC-SG76RJ-E (unit side:  $\phi 9.52$  diameter, onsite pipe side:  $\phi 15.88$  diameter)
- PAC-493PI (unit side:  $\phi 6.32$  diameter, onsite pipe side:  $\phi 9.52$  diameter)
- MAC-A454JP-E (unit side:  $\phi 9.52$  diameter, onsite pipe side:  $\phi 12.7$  diameter)
- MAC-A455JP-E (unit side:  $\phi 12.7$  diameter, onsite pipe side:  $\phi 9.52$  diameter)
- MAC-A456JP-E (unit side:  $\phi 12.7$  diameter, onsite pipe side:  $\phi 15.88$  diameter)

Unit side       Onsite piping side

#### Installation procedure

(carefully read the following before installing.)

This optional part is used to connect indoor/outdoor unit to onsite pipes of different diameters.

※ When installing this optional part, be sure to read "Refrigerant pipe connection" in the installation manual attached to outdoor unit.

1) Apply flare processing to onsite pipes to adapt to R410A, according to the table on the right. Use optional accessory flare nut at this time.

※ Check the installation manual attached to the outdoor unit for advisability on whether or not onsite (existing) pipes can be used.

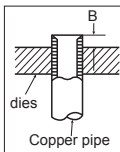

Pipe diameter (mm)	B size (mm)	
	R410A flare tool	R22/R407C flare tool
	Clutch type	
$\phi 6.35$ (1/4")	0~0.5	1.0~1.5
$\phi 9.52$ (3/8")	0~0.5	1.0~1.5
$\phi 12.70$ (1/2")	0~0.5	1.0~1.5
$\phi 15.88$ (5/8")	0~0.5	1.0~1.5

※ When flare processing for refrigerant R410A is applied using current tool, refer to the table above. B size can be secured using copper pipe gauge for margin adjustment.

Outer diameter of copper pipe (mm)	Processing size of flare section (mm)	Flare shape
$\phi 6.35$	8.7~9.1	
$\phi 9.52$	12.8~13.2	
$\phi 12.70$	16.2~16.6	
$\phi 15.88$	19.3~19.7	

2) Remove caps (both ends) for protection against mixing of foreign materials from optional part, and thinly apply refrigerant or oil (locally procured) on flare surface.

Refrigerator oil application point

Apply refrigerant oil to entire circumference of flare sheet surface.

※ Do not apply to thread section. (If applied to threads, flare nut can easily be loosened.)

3) Securely tighten flare nut using torque wrench according to the table on the right.

(Proper tightening torque using torque wrench)

Outer diameter of copper pipe (mm)	Tightening torque N·m (kgf·cm)
$\phi 6.35$	14~18 (140~180)
$\phi 9.52$	34~42 (340~420)
$\phi 12.70$	49~61 (490~610)
$\phi 15.88$	68~82 (680~820)

4) After refrigerant pipe is connected, be sure to perform gas leakage inspection for onsite connection pipes (including this optional part) and indoor/outdoor unit.

5) Heat insulation is necessary for this optional part: Wrap heat insulator (locally procured) around the onsite pipes and also the optional part (for dewdrop dripping prevention).

6) Perform test run according to the installation manual of the unit, making sure to also perform operation check.

OPTIONAL PARTS



## SPLIT-TYPE AIR CONDITIONERS INSTALLATION MANUAL

DG79A04VH01

**MSZ-GS06/09/12/15NA**  
**MSY-GS09/12/15NA**

When installing multi units, refer to the installation manual of the multi unit for outdoor unit installation.

### Required Tools for Installation

Phillips screwdriver	5/32 in. (4 mm) hexagonal wrench
Level	Flare tool for R410A
Scale	Gauge manifold for R410A
Utility knife or scissors	Vacuum pump for R410A
3 in. (75 mm) hole saw	Charge hose for R410A
Torque wrench	Pipe cutter with reamer
Wrench (or spanner)	

## 1. BEFORE INSTALLATION

### 1-1. THE FOLLOWING SHOULD ALWAYS BE OBSERVED FOR SAFETY

- Be sure to read these safety precautions and instructions.
- Be sure to observe the warnings and cautions specified here.
- After reading this manual, be sure to store it with the OPERATING INSTRUCTIONS for future reference.
- Please report to your supply authority or obtain their consent before connecting this equipment to the power supply system.

#### **⚠ WARNING** (Could lead to death or serious injury.)

- **Do not install the unit by yourself (user).**  
Improper or incomplete installation could cause fire, electric shock, injury due to the unit falling, or water leakage. Consult a qualified installer or the dealer from whom you purchased the unit.
- **Follow the instructions detailed in the installation manual.**  
Incomplete installation could cause fire or electric shock, injury due to the unit falling, or leakage of water.
- **When installing the unit, use appropriate protective equipment and tools for safety.**  
Failure to do so could cause injury.
- **Install the unit securely in a place that can bear the weight of the unit.**  
If the installation location cannot bear the weight of the unit, the unit could fall causing injury.
- **Do not alter the unit.**  
It may cause fire, electric shock, injury or water leakage.
- **Perform electrical work according to the installation manual and be sure to use an exclusive circuit. Do not connect other electrical appliances to the circuit.**  
If the capacity of the power circuit is insufficient or there is incomplete electrical work, it could result in a fire or an electric shock.
- **Ground the unit correctly.**  
Do not connect the ground wire to a gas pipe, water pipe, lightning rod or telephone ground. Defective grounding could cause electric shock.
- **Do not damage the wires.**  
Damaged wires could cause fire.
- **Be sure to shut off the main power when setting up the indoor P.C. board or wiring.**  
Failure to do so could cause electric shock.
- **Use the specified wires to securely connect the indoor and outdoor units. Attach the wires firmly to avoid applying stress to the terminal block.**  
Improper connection could cause fire.
- **Do not install the unit in a place where flammable gas may leak.**  
If gas leaks and accumulates around the unit, it could cause an explosion.
- **Do not use intermediate connection of the power cord or the extension cord. Do not connect many devices to one AC outlet.**  
It could cause a fire or an electric shock.
- **Use the parts provided or specified parts for the installation work.**  
The use of defective parts could cause an injury or leakage of water due to a fire, an electric shock, the unit falling, etc.
- **When plugging the power supply plug into the outlet, make sure that there is no dust, blockage, or loose parts both in the outlet and on the plug. Verify that the power supply plug is completely in the outlet.**  
If there is dust, blockage, or loose parts on the power supply plug or the outlet, it could cause electric shock or fire. If loose parts are found on the power supply plug, replace it.
- **Securely attach the electrical cover to the indoor unit and the service panel to the outdoor unit.**  
If the electrical cover of the indoor unit and/or the service panel of the outdoor unit are not attached securely, dust, water, etc. could collect in the unit and could cause a fire or an electric shock.
- **When installing, relocating, or servicing the unit, make sure that no substance other than the specified refrigerant (R410A) enters the refrigerant circuit.**  
Any presence of foreign substance such as air can cause abnormal pressure rise and may result in explosion or injury. The use of any refrigerant other than that specified for the system will cause mechanical failure, system malfunction, or unit breakdown. In the worst case, this could lead to a serious impediment to securing product safety.
- **Do not discharge the refrigerant into the atmosphere. Check that the refrigerant gas does not leak after installation has been completed. If refrigerant leaks during installation, ventilate the room.**  
If refrigerant comes in contact with a fire, harmful gas could be generated. If refrigerant gas leaks indoors, and comes into contact with the flame of a fan heater, space heater, stove, etc., harmful gases will be generated.
- **Use appropriate tools and piping materials for installation.**  
The pressure of R410A is 1.6 times higher than R22. Not using the appropriate tools and materials, or improper installation could cause the pipes to burst causing an injury.
- **When pumping down the refrigerant, stop the compressor before disconnecting the refrigerant pipes.**  
If the refrigerant pipes are disconnected while the compressor is running and the stop valve is open, air could be drawn in and the pressure in the refrigeration cycle could become abnormally high, causing the pipes to burst.
- **When installing the unit, securely connect the refrigerant pipes before starting the compressor.**  
If the compressor is started before the refrigerant pipes are connected and the stop valve is open, air could be drawn in and the pressure in the refrigeration cycle could become abnormally high, causing the pipes to burst.
- **Fasten a flare nut with a torque wrench as specified in this manual.**  
If fastened too tight, a flare nut could break and cause refrigerant leakage.
- **Install the unit according to national wiring regulations.**
- **When opening or closing the valve below freezing temperatures, refrigerant may spurt out from the gap between the valve stem and the valve body, resulting in injuries.**

#### **⚠ CAUTION** (Could lead to serious injury when operated incorrectly.)

- **Depending on the installation area, install a Ground Fault Interrupt (GFI) circuit breaker.**  
If the Ground Fault Interrupt (GFI) circuit breaker is not installed, an electric shock could occur.
- **Perform the drainage/piping work securely according to the installation manual.**  
If there is defect in the drainage/piping work, water could drip from the unit, and damage household items.
- **Do not touch the air inlet or the aluminum fins of the outdoor unit.**  
This could cause injury.
- **Do not install the outdoor unit where small animals may live.**  
If small animals enter the unit and damage its electrical parts, it could cause a malfunction, smoke emission, or fire. Keep the area around the unit clean.

## 1-2. SELECTING THE INSTALLATION LOCATION

### INDOOR UNIT

- Where airflow is not blocked.
- Where cool (or warm) air spreads over the entire room.
- On a rigid wall to reduce the possibility of vibration.
- Where it is not exposed to direct sunlight. Do not expose to direct sunlight also during the period following unpacking to before use.
- Where it can be easily drained.
- At a distance 3 ft. (1 m) or more away from a TV and radio. Operation of the air conditioner may interfere with radio or TV reception. An amplifier may be required for the affected device.
- In a place as far away as possible from fluorescent and incandescent lights (so the infrared remote control can operate the air conditioner normally).
- Where the air filter can be removed and replaced easily.
- Where it is away from the other heat or steam source.

#### Note:

Install the indoor unit high on the wall where air can distribute over the entire room.

### REMOTE CONTROLLER

- Where it is convenient to operate and easily visible.
- Where children cannot easily touch it.
- Select a position about 4 ft. (1.2 m) above the floor. Check that signals from the remote controller from that position are received by the indoor unit ('beep' or 'beep beep' receiving tone sounds). Then, attach remote controller holder to a pillar or wall and install wireless remote controller.

#### Note:

In rooms where inverter type fluorescent lamps are used, the signal from the wireless remote controller may not be received.

### OUTDOOR UNIT

- Where it is not overly exposed to strong winds. If the outdoor unit is exposed to a wind during defrosting, the defrosting time will be longer.
- Where airflow is good and dustless.
- Where neighbours are not annoyed by operation sound or hot (or cool) air.
- Where rigid wall or support is available to prevent the increase of operation sound or vibration.
- Where there is no risk of combustible gas leakage.
- If installing the unit in a location high above the ground, be sure to secure the unit legs.
- Where it is at least 10 ft. (3 m) away from the antenna of TV set or radio. Operation of the air conditioner may interfere with radio or TV reception in areas where reception is weak. An amplifier may be required for the affected device.
- Install the unit horizontally.
- Please install it in an area not affected by snowfall or blowing snow. In areas with heavy snow, please install a canopy, a pedestal and/or baffle boards.

#### Note:

- It is advisable to make a piping loop near outdoor unit so as to reduce vibration.
- For increased efficiency, install the outdoor unit in a location where continuous direct sunlight or excessive water can be avoided as much as possible.

#### Note:

When operating the air conditioner in low outside temperature, be sure to follow the instructions described below.

- Never install the outdoor unit in a place where its air inlet/outlet side may be exposed directly to wind.
- To prevent exposure to wind, install the outdoor unit with its air inlet side facing the wall and a baffle board on the air outlet side.

Avoid the following places for installation where air conditioner trouble is liable to occur.

- Where flammable gas could leak.
- Where there is an excessive amount of machine oil in the air.
- Where oil is splashed or where the area is filled with oily smoke (such as cooking areas and factories, in which the properties of plastic could be changed and damaged).
- Salty places such as the seaside.
- Where sulfide gas is generated such as hot spring, sewage, waste water.
- Where there is high-frequency or wireless equipment.
- Where there is emission of high levels of VOCs, including phthalate compounds, formaldehyde, etc., which may cause chemical cracking.

## 1-3. SPECIFICATIONS

### 1-3-1. POWER SUPPLY AND INDOOR/OUTDOOR WIRE CONNECTION

- Power should be taken from an exclusive branched circuit.
- Wiring work should be based on applicable technical standards.
- Wiring connections should be made following the diagram.
- Securely tighten screws.

#### Connecting wires and the ground wire

- Use solid conductor Min. AWG14 or stranded conductor Min. AWG14.
- Use double insulated copper wire with 600 V insulation.
- Use copper supply wire.
- \* Follow local electrical codes.

#### Power supply cable and ground wire

- Use solid or stranded conductor Min. AWG14.
- Use copper supply wire.
- \* Follow local electrical codes.

#### Note:

When the indoor unit is powered from the outdoor unit, depending on local code, a disconnect switch needs to be installed to a power supply circuit.

### Electrical specifications

MODEL	INDOOR	MSZ-GS06NA	MSZ-GS09NA MSY-GS09NA		MSZ-GS12NA MSY-GS12NA		MSZ-GS15NA MSY-GS15NA		
	OUTDOOR	-	MUZ-GS09NA(H) MUY-GS09NA	MUZ-GS09NAHZ	MUZ-G12NA(H) MUY-GS12NA	MUZ-GS12NAHZ	MUZ-G15NA(H) MUY-GS15NA	MUZ-GS15NAHZ	
<b>INDOOR UNIT</b>									
Power supply (V, PHASE, Hz)		208/230, 1, 60							
Min. Circuit Ampacity (A)		1.0							
Fan motor (F.L.A.) (A)		0.75							
<b>OUTDOOR UNIT</b>									
Power supply (V, PHASE, Hz)		208/230, 1, 60							
Max. Fuse size (time delay) (A)		*	15	15	15	15	15	15	
Min. Circuit Ampacity (A)		*	10	10	10	10	10	10	
Fan motor (F.L.A.) (A)		*	0.50	0.50	0.50	0.50	0.50	0.50	
Compressor	(R.L.A) (A)	MSZ	*	6.7	6.7	6.7	7.4	7.4	7.4
		MSY	*	6.7	-	6.7	-	7.4	-
	(L.R.A) (A)	MSZ	*	8.4	8.4	8.4	9.2	9.2	9.2
		MSY	*	8.4	-	8.4	-	9.2	-
Control voltage		Indoor unit - Remote controller: (Wireless) Indoor unit - Outdoor unit: DC12-24 V (Polar)							

\* MSZ-GS06NA is a dedicated indoor unit for multi system. Refer to the installation manual of the multi unit for details.

### 1-3-2. REFRIGERANT PIPES

- To prevent condensation, insulate the two refrigerant pipes.



#### CAUTION

Be sure to use the insulation of specified thickness (table on the right). Excessive insulation may cause incorrect installation of the indoor unit, and too little insulation may cause condensate to form.

- Refrigerant pipe bending radius must be 4 in. (100 mm) or more.
- The unit has flared connections on both indoor and outdoor sides.
- Remove the valve cover from the outdoor unit, then connect the pipe.
- Refrigerant pipes are used to connect the indoor and outdoor units.
- Be careful not to crush or over bend the pipe in pipe bending.
- Refrigerant adjustment... If pipe length exceeds 25 ft. (7.5 m), additional refrigerant (R410A) charge is required. (The outdoor unit is charged with refrigerant for pipe length up to 25 ft. [7.5 m])
- Please carefully consider the indoor unit location when piping lengths are less than 16 ft. (5 m) as there could be intermittent noises during normal operation that would be noticeable in very quiet environments.

Pipe	Outside diameter	Minimum wall thickness	Insulation thickness	Insulation material
For liquid	1/4 (6.35)	0.0315 (0.8)	5/16 (8)	Heat resistant foam plastic 0.045 Specific gravity
For gas	3/8 (9.52)	0.0315 (0.8)	5/16 (8)	
	1/2 (12.7)	0.0315 (0.8)	5/16 (8)	

Limits		
Pipe length	MSZ/MSY-GS09/12/15NA	65 ft. (20 m) max.
Height difference	MSZ/MSY-GS09/12/15NA	40 ft. (12 m) max.
No. of bends		10 max.

Pipe length	Up to 25 ft. (7.5 m)	No additional charge is required.
	Exceeding 25 ft. (7.5 m)	Additional charge is required. (Refer to the table below.)
Refrigerant to be added	MSZ/MSY-GS09/12/15NA	1.08 oz each 5 ft. (20 g/m)

# 1-4. INSTALLATION DIAGRAM

## ACCESSORIES

Check the following parts before installation.  
<Indoor unit>

(1)	Installation plate	1
(2)	Attachment screws for the installation plate 4 × 25 mm	5
(3)	Wireless remote controller	1
(4)	Felt tape (For left or left-rear piping)	1
(5)	Remote controller holder	1
(6)	Screws for the remote controller holder 3.5 × 16 mm (Black)	2
(7)	Battery (AAA) for (3)	2
(8)	Air cleaning filter	2

## FIELD-SUPPLIED PARTS

(A)	Indoor/outdoor unit connecting wire*1	1
(B)	Extension pipe	1
(C)	Wall hole sleeve	1
(D)	Wall hole cover	1
(E)	Pipe attachment strap	2 to 5
(F)	Screw for (E) 4 × 20 mm	2 to 5
(G)	Piping tape	1
(H)	Putty	1
(I)	Drain hose (or soft PVC hose, 19/32 in. [15 mm] inner diameter or hard PVC pipe VP16)	2 to 5
(J)	Refrigerant oil	1
(K)	Power supply cord*1	1

### Note:

\*1 Place indoor/outdoor unit connecting wire (A) and power supply cord (K) at least 3 ft. (1 m) away from the TV antenna wire.

\*2 4 in. (100 mm) or more when front and sides of unit are clear

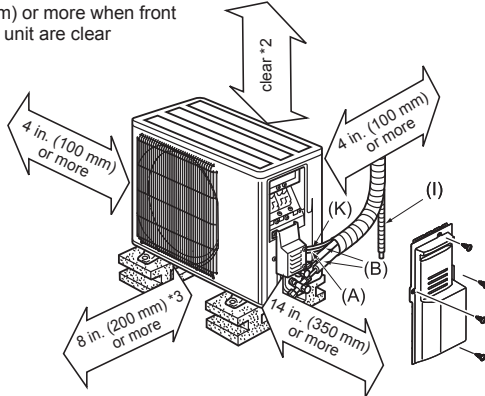

\*3 When any 2 sides of left, right and rear of unit are clear

Units should be installed by licensed contractor according to local code requirements.

### Note:

- The dimensions indicated in the arrows (↔) above show the required space to guarantee performance of the air conditioner. Install the outdoor unit where the maximum possible space can be provided, considering later relocation, services, or repairs.
- The cooling/heating performance and the efficiency of power usage may fall about 10% at the place where short cycle is likely occur due to poor ventilation. Installing the air outlet guide (optional) can improve performances.
- If air from the outlet blows against the wall, it may cause stains on the wall.



Do not take in the outlet air discharged by other units directly.

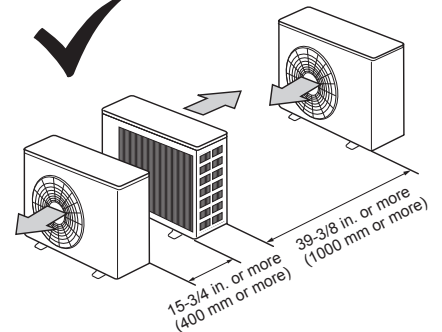
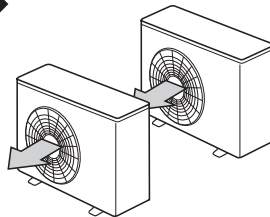

Use the wall hole sleeve (C) to prevent indoor/outdoor connecting wire (A) from contacting metal parts in the wall and to protect the wiring from rodents.

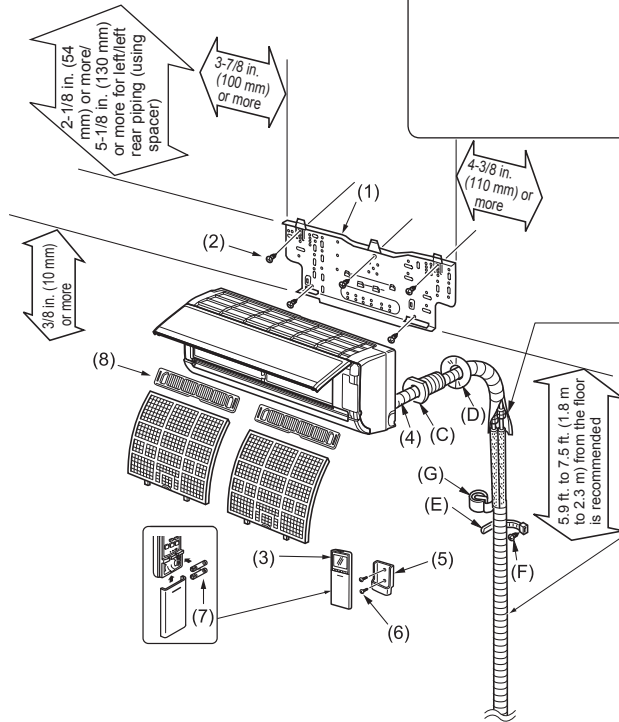
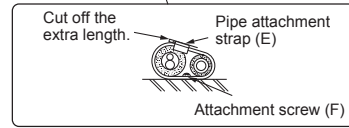
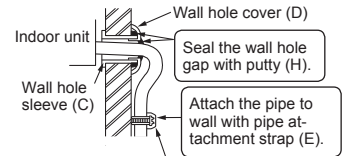

After the leak test, apply insulating material tightly so that there is no gap.

When the piping is to be attached to a wall comprised of tin plate or metal netting, use chemically treated wooden piece 25/32 in. (20 mm) or thicker between the wall and the piping, or wrap insulation vinyl tape 7 to 8 turns around the piping.  
To use existing piping, perform COOL operation for 30 minutes and pump down before removing the old air conditioner. Remake flare according to the dimension for new refrigerant.

Unit: inch

Unit: mm

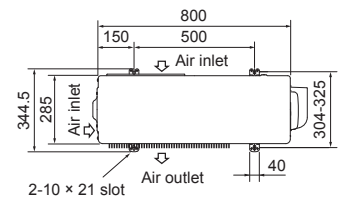
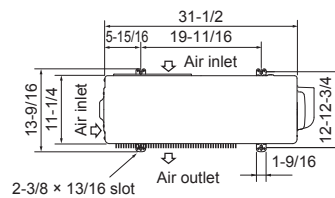

### Drain piping for outdoor unit

Install the unit horizontally.

Do not use drain socket in cold regions. Drain may freeze and make the fan stop.

The outdoor unit produces condensate during the heating operation. Select the installation place to ensure to prevent the outdoor unit and/or the grounds from being wet by drain water or damaged by frozen drain water.

## 2. INDOOR UNIT INSTALLATION

### 2-1. ATTACHING THE INSTALLATION PLATE

- Find a stud in the wall to attach installation plate (1) horizontally by tightening the fixing screws (2) firmly.
- To prevent installation plate (1) from vibrating, be sure to install the attachment screws in the holes indicated in the illustration. For added support, additional screws may also be installed in other holes.
- When the indoor unit is to be attached to a concrete wall using recessed bolts, secure installation plate (1) using 7/16 in. x 13/16 in. · 7/16 in. x 1 in. (11 mm x 20 mm · 11 mm x 26 mm) oval hole (17-3/4 in. [450 mm] pitch).
- If the recessed bolt is too long, change it for a shorter one (field-supplied).

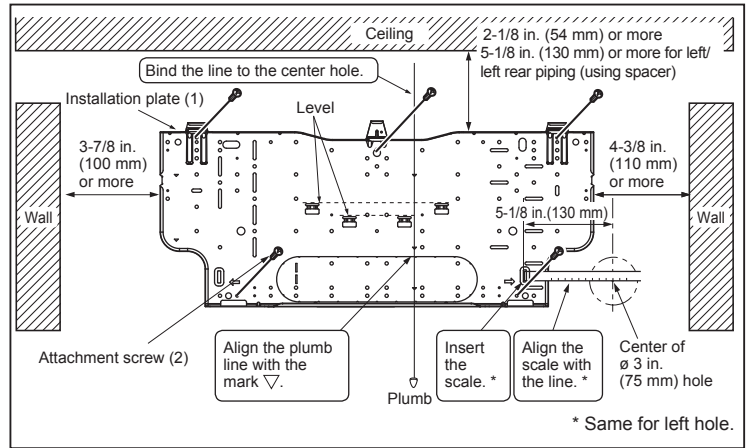

### 2-2. DRILLING

- 1) Determine where the holes will be located on the wall.
- 2) Drill a  $\varnothing$  3 in. (75 mm) hole. The outdoor side should be 6/32 to 9/32 in. (5 to 7 mm) lower than the indoor side.
- 3) Insert wall hole sleeve (C).

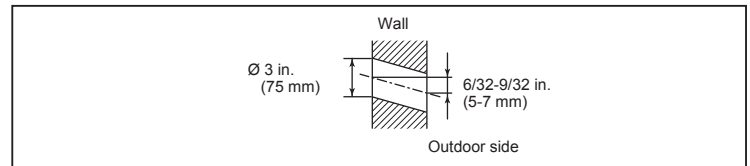

### 2-3. CONNECTING WIRES FOR INDOOR UNIT

#### Note:

When the indoor unit is powered from the outdoor unit, depending on local code, a disconnect switch needs to be installed to a power supply circuit.

- 1) Remove the panel assembly. (Refer to 5-1.)
- 2) Place the upper part of the indoor unit on the installation plate.
- 3) Remove corner box and electrical cover.
- 4) Remove display panel, conduit cover and conduit plate.
- 5) Attach conduit pipe (for rear piping) / elbow joint (for right, left, or downward piping) to conduit plate with lock nut. The thread of the installed conduit pipe / elbow joint appearing inside should be less than 3/8 in. (10 mm). (Fig. 1) Elbow joint should appear less than 1-3/16 in. (30 mm) outside. (Fig. 2)
- 6) Process the end of ground wire (Fig. 3). Connect it to the ground terminal of electrical parts box.
- 7) Process the end of indoor/outdoor unit connecting wire (A) (Fig. 3). Attach it to the terminal block. Be careful not to make mis-wiring. Attach the wire to the terminal block securely so that its core cannot be seen, and no external force affects the connecting section of the terminal block.
- 8) Firmly tighten the terminal screws. After tightening, verify that the wires are tightly fastened.
- 9) Reinstall conduit plate, conduit cover and display panel.
- 10) According to the piping direction, remove the shaded part of the left side of box (Fig. 4) or corner box (Fig. 5). Reinstall electrical cover, corner box and front panel.

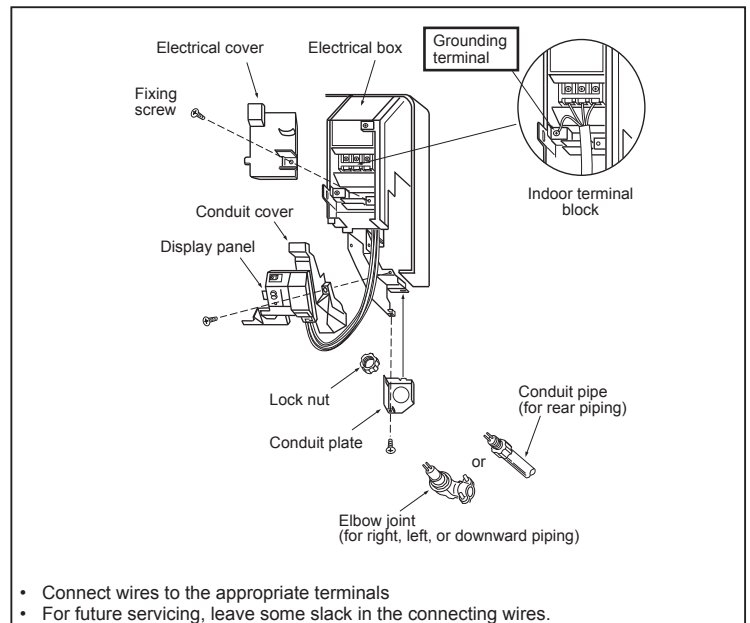

#### Remark:

- \* A disconnect switch should be required. Check the local code.
- \*\* Use a ring tongue terminal in order to connect a ground wire to terminal.

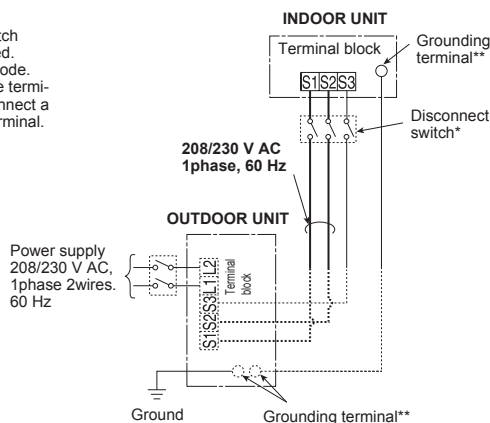

- Connect wires to the appropriate terminals
- For future servicing, leave some slack in the connecting wires.

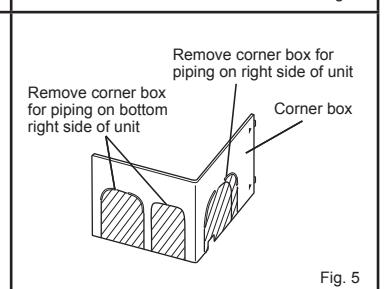
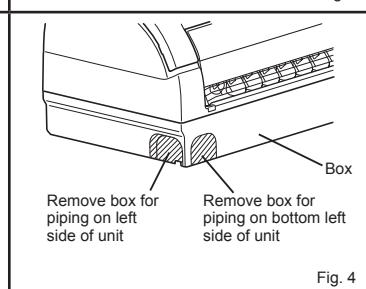
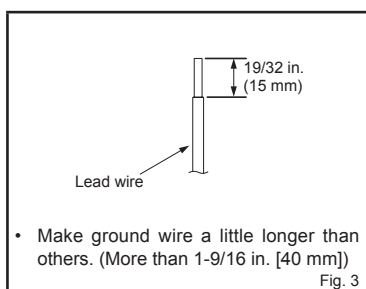
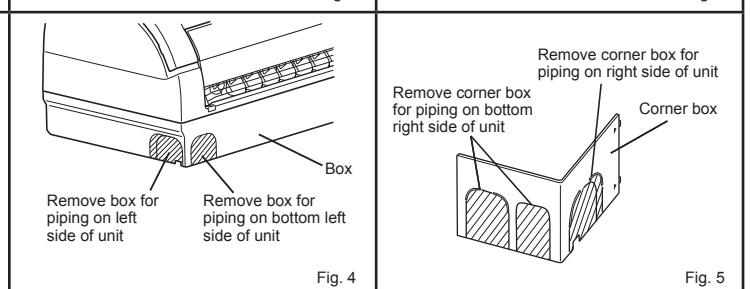
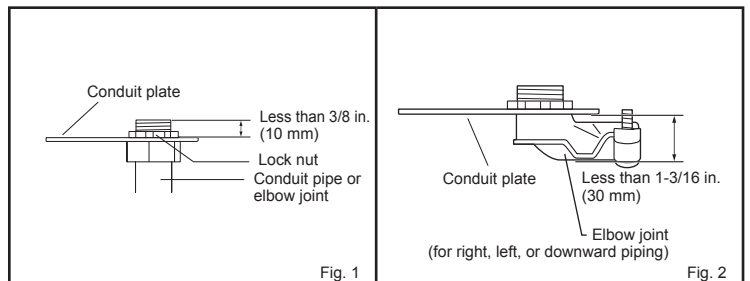

## 2-4. PIPE FORMING AND DRAIN PIPING

### 2-4-1. PIPE FORMING

- Place the drain hose below the refrigerant piping.
- Make sure that the drain hose is not crowded or bent.
- Do not pull the hose when applying the tape.
- When the drain hose passes the room, be sure to wrap it with insulation material (field-supplied).

**Note:**  
Make sure not to damage the cover of refrigerant pipe when attaching it back on with screws.

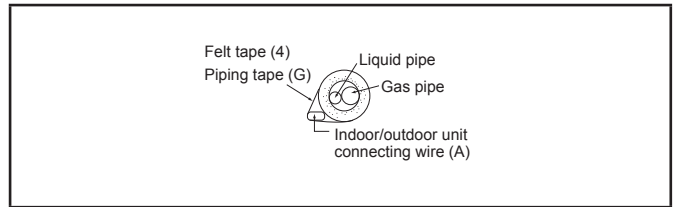

### Left or left-rear piping

**Note:**  
Be sure to reattach the drain hose and the drain cap if the piping is being installed on left or left-rear of unit, otherwise, water could drip down from the drain hose.

- Place the refrigerant piping and the drain hose together, then firmly apply felt tape (4) from the end.  
Felt tape (4) overlap width should be 1/3 the tape width. Use a bandage stopper at the end of felt tape (4).
- Pull out the drain cap at the back right of the indoor unit. (Fig. 1)
  - Hold the convex section at the end and pull the drain cap.
- Pull out the drain hose at the back left of the indoor unit. (Fig. 2)
  - Hold the claw marked by the arrows and pull out the drain hose forward.
- Put the drain cap into the section to which the drain hose is to be attached at the rear of the indoor unit. (Fig. 3)
  - Insert a screwdriver into the hole on the cap and insert the cap fully into the drain pan.
- Insert the drain hose fully into the drain pan at the back right of the indoor unit. (Fig. 4)
  - Check if the hose is hooked securely to the projection of its inserting part at the drain pan.
- Insert the drain hose into wall hole sleeve (C), and attach the upper part of indoor unit onto the installation plate (1). Then, shift the indoor unit completely to the left to make placing the piping in the back of the unit easier.
- Cut out a piece of cardboard from the shipping box, roll it up, hook it onto the back rib, and use it as a spacer to lift the indoor unit. (Fig. 5)
- Connect the refrigerant piping with the extension pipe (B).
- Attach the lower part of the indoor unit into the installation plate (1).

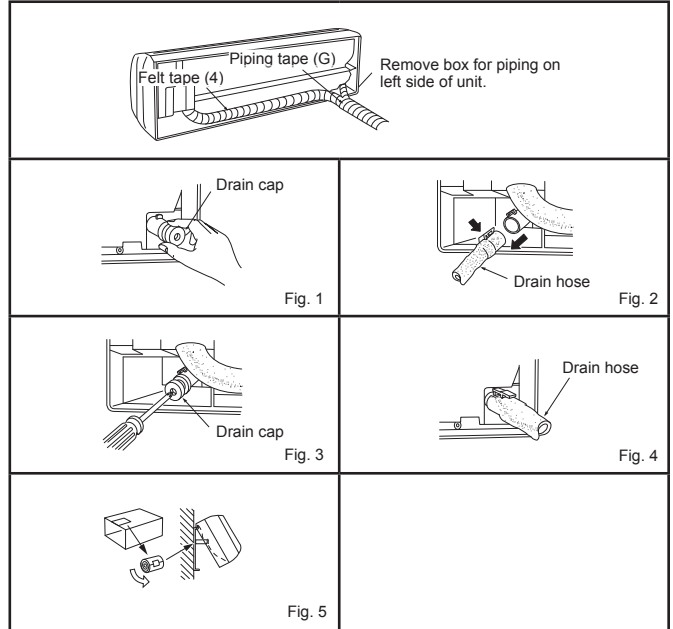

### Rear or bottom piping

- Place the refrigerant piping and the drain hose together, then firmly apply piping tape (G) from the end.
- Insert the piping and the drain hose into the wall hole sleeve (C), and attach the upper part of the indoor unit on the installation plate (1).
- Check if the indoor unit is attached securely on the installation plate (1) by moving the unit to left and right.
- Attach the lower part of the indoor unit into the installation plate (1).

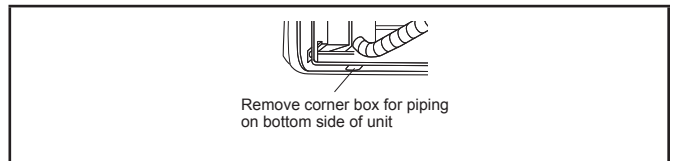

### Right piping

- Note:**  
Before performing the following, make sure that wiring is completed, and the conduit cover is installed. (Refer to 2-3.)
- Place the refrigerant piping and the drain hose together, shift them to left side of the unit, and then firmly apply piping tape (G) from the end.
  - Insert the piping and the drain hose into the wall hole sleeve (C), and attach the upper part of the indoor unit on the installation plate (1).
  - Check if the indoor unit is attached securely on the installation plate (1) by moving the unit to left and right.
  - Attach the lower part of the indoor unit into the installation plate (1).

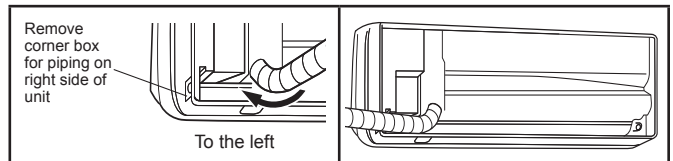

### 2-4-2. DRAIN PIPING

- If the extension drain hose has to pass through a room, be sure to wrap it with insulation (field-supplied).
- The drain hose should point downward for easy drain. (Fig. 1)
- If the drain hose provided with the indoor unit is too short, connect it with a field-supplied drain hose (I). (Fig. 2)
- When connecting the drain hose to a hard vinyl chloride pipe, be sure to insert it securely into the pipe. (Fig. 3)

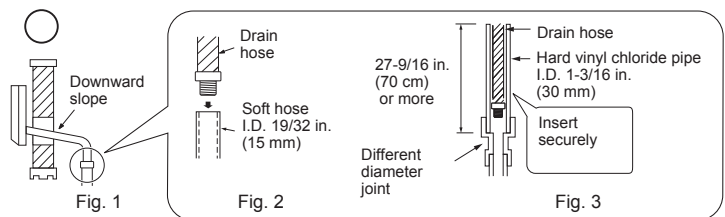

Do not put the drain pipe directly in a drainage ditch where Ammonia or Sulphuric gas may be generated. The evaporated corrosive gas may return to the indoor side through drain pipe and this may cause an unpleasant odor and corrosion on Heat exchanger may occur.

Do not make drain piping as shown below.

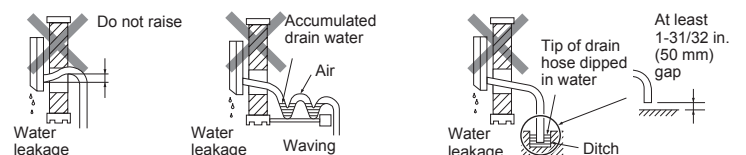

### 3. OUTDOOR UNIT INSTALLATION

#### 3-1. CONNECTING WIRES FOR OUTDOOR UNIT

- 1) Remove the service panel.
- 2) Remove the conduit cover.
- 3) Attach the conduit connectors to the conduit plate with lock nuts then secure it against unit with screws.
- 4) Connect the ground wires of indoor/outdoor unit connecting wire (A) and power supply cord (K) to the TB support.
- 5) Loosen the terminal screws, then attach indoor/outdoor unit connecting wire (A) and power supply cord (K) from the indoor unit correctly to the terminal block. Attach the wires to the terminal block securely so that the cores cannot be seen, and no external force affects the connecting section of the terminal block.
- 6) Firmly tighten the terminal screws. After tightening, verify that the wires are tightly fastened.
- 7) Install the conduit cover.
- 8) Install the service panel securely.

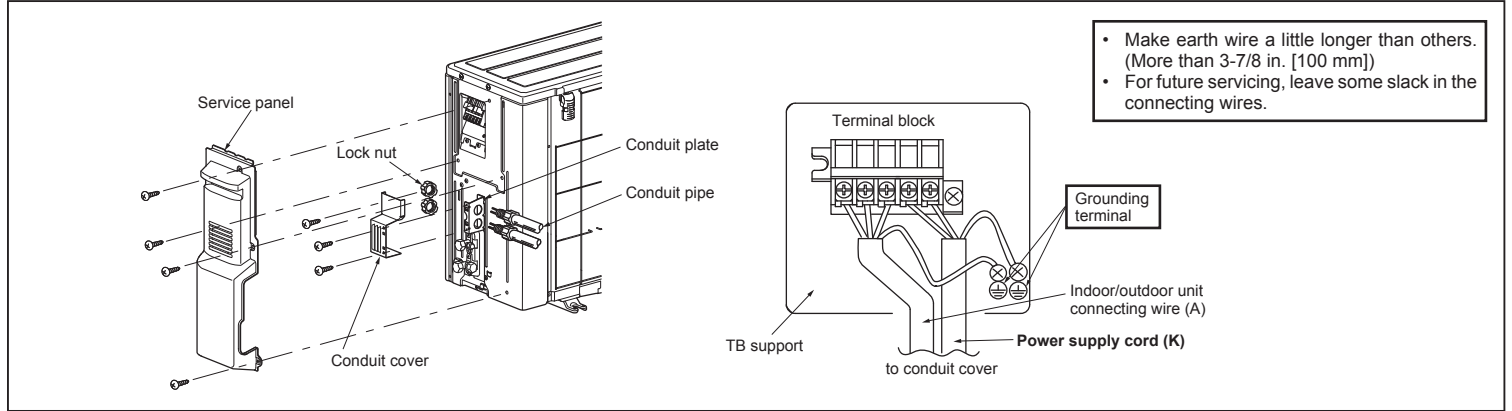
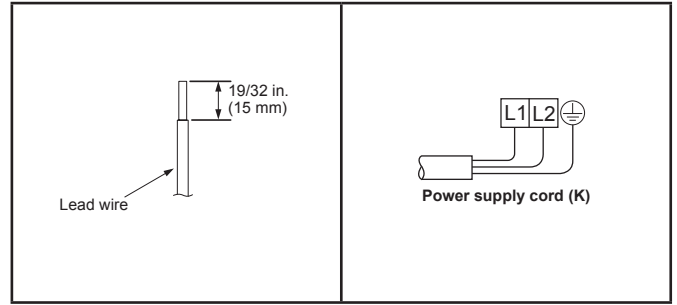

#### 3-2. FLARE CONNECTION

- 1) Cut the copper pipe as straight as possible with a pipe cutter. (Fig. 1, 2)
- 2) Remove all burrs from the cut section of the pipe, ensuring that precautions are taken to avoid getting metal shavings into the piping. (Fig. 3)
- 3) Remove flare nuts attached to indoor and outdoor units, then put them on pipe.
- 4) Flaring work (Fig. 4, 5). Firmly hold copper pipe in the dimension shown in the table. Select A inch (mm) from the table according to the tool you use.
- 5) Check
  - Compare the flared work with Fig. 6.
  - If flare is defective, cut off the section and repeat procedure.

Pipe diameter inch (mm)	B inch (mm)	A inch (mm)			Tightening torque	
		Clutch type tool for R410A	Clutch type tool for R22	Wing nut type tool for R22	ft-lb (kgf·cm)	N·m
ø 1/4 (6.35)	21/32 (17)	0 to 0.02 (0 to 0.5)	0.04 to 0.06 (1.0 to 1.5)	0.06 to 0.08 (1.5 to 2.0)	10 to 13 (140 to 180)	13.7 to 17.7
ø 3/8 (9.52)	7/8 (22)			25 to 30 (350 to 420)	34.3 to 41.2	
ø 1/2 (12.7)	1-1/32 (26)			0.08 to 0.10 (2.0 to 2.5)	36 to 42 (500 to 575)	49.0 to 56.4
ø 5/8 (15.88)	1-5/32 (29)			54 to 58 (750 to 800)	73.5 to 78.4	

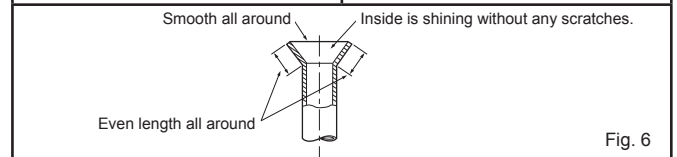
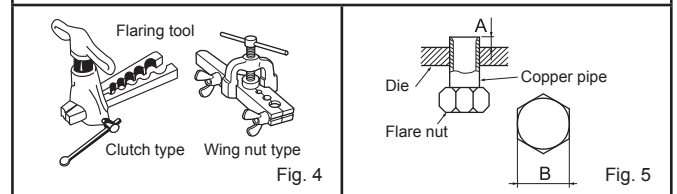
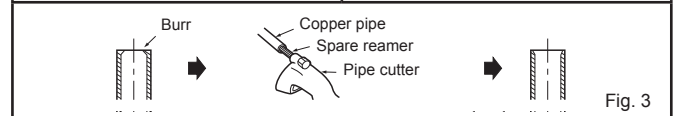
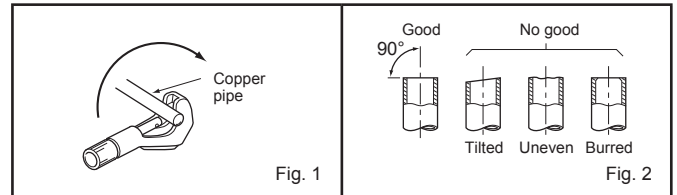

#### 3-3. PIPE CONNECTION

- Fasten flare nut with a torque wrench as specified in the table (refer to 3-2).
- When fastened too tight, flare nut may eventually break and cause refrigerant leakage.
- Be sure to wrap insulation around the piping. Direct contact with the bare piping may result in burns or frostbite.

##### Indoor unit connection

- Connect both liquid and gas pipings to indoor unit.
- Apply a thin coat of refrigeration oil (J) on the flared ends of the pipes. Do not apply refrigeration oil on screw threads. Excessive tightening torque will result in damage on the screw.
  - To connect, first align the center, then tighten the first 3 to 4 turns of flare nut by hand.
  - Use tightening torque table above as a guideline for indoor unit side joints, and tighten using two wrenches. Excessive tightening damages the flare section.

##### Outdoor unit connection

- Connect pipes to stop valve pipe joint of the outdoor unit following the same procedure detailed in Indoor unit connection.
- For tightening, use a torque wrench or spanner.

#### ⚠ WARNING

**When installing the unit, securely connect the refrigerant pipes before starting the compressor.**

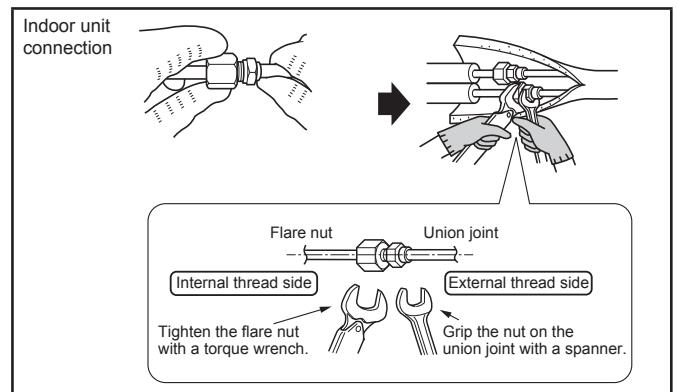

#### 3-4. INSULATION AND TAPING

- 1) Cover piping joints with pipe cover.
- 2) For outdoor unit side, insulate the piping, including valves.
- 3) Apply piping tape (G) starting from the connection on the outdoor unit.
  - When piping has to be installed through a ceiling, closet or where the temperature and humidity are high, use additional field-supplied insulation to prevent condensation.

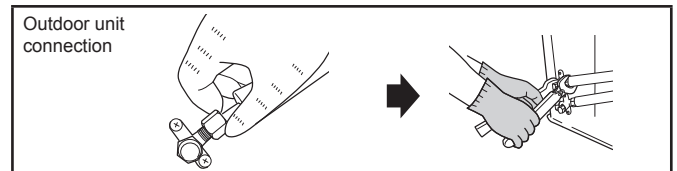

## 4. PURGING PROCEDURES, LEAK TEST, AND TEST RUN

### 4-1. PURGING PROCEDURES AND LEAK TEST

- 1) Remove service port caps from stop valves on both sides of refrigerant lines. (The stop valves are fully closed when shipped.) Leave closed.
- 2) Connect gauge manifold to ports of stop valves.

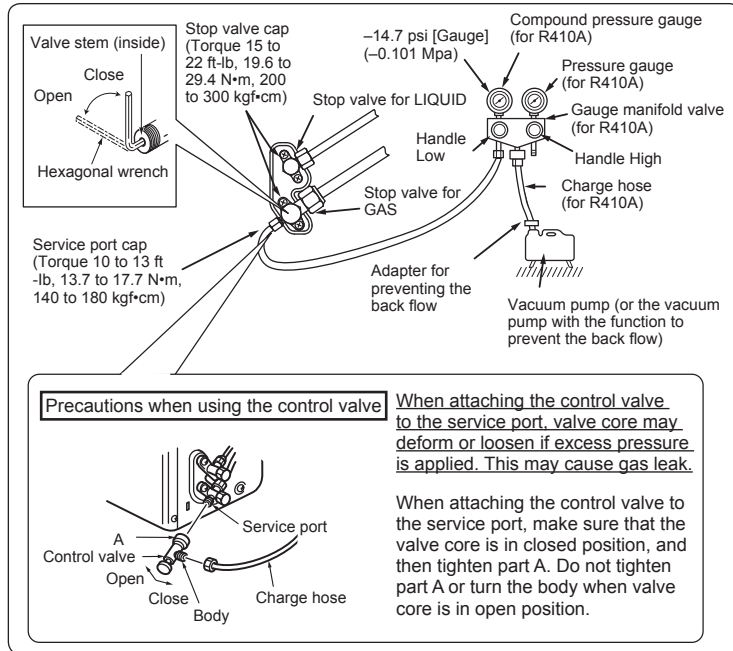

- 3) Evacuate the system to 4000 microns from both service valves. System manifold gauges must not be used to measure vacuum. A micron gauge must be used at all times. Break the vacuum with Nitrogen(N<sub>2</sub>) into the discharge service valve to 0 PSIG.
- 4) Evacuate the system to 1500 microns. Break the vacuum with Nitrogen(N<sub>2</sub>) into the discharge service valve to 0 PSIG.
- 5) Evacuate the system to 500 microns.
- 6) Close gauge manifold valves, stop the pump, and conduct a 30 minute rise test.
- 7) System should hold 500 microns for a minimum of 1 hour.
- 8) Fully open the valve stem of all stop valves on both sides of gas pipe and liquid pipe by the hexagonal wrench. If the valve stem hits the stopper, do not turn it any further. Operating without fully opening lowers the performance and this causes trouble.
- 9) Refer to 1-3 and charge the prescribed amount of additional refrigerant if needed. Be sure to charge slowly with liquid refrigerant. Otherwise composition of the refrigerant in the system may be changed and affect performance of the air conditioner.
- 10) Remove gauge manifolds and replace service port caps and tighten.
- 11) Leak test

### 4-2. TEST RUN

- 1) Insert power supply plug into the power outlet and/or turn on the breaker.
- 2) Press the E.O. SW once for COOL, and twice for HEAT (only MSZ series) operation. Test run will be performed for 30 minutes. If the upper lamp blinks every 0.5 seconds, inspect the indoor/outdoor unit connecting wire (A). After the test run, emergency COOL mode (75°F [24°C] COOL) will start.
- 3) To stop operation, press the E.O. SW several times until all LED lamps turn off. Refer to operating instructions for details.

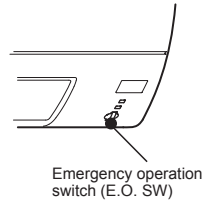

### Checking the remote (infrared) signal reception

Press the OFF/ON button on the remote controller (3) and listen for an audible indicator from the indoor unit. Press the OFF/ON button again to turn the air conditioner off.

- Once the compressor stops, the restart preventive device operates so the compressor will not operate for 3 minutes to protect the air conditioner.

### 4-3. AUTO RESTART FUNCTION

This product is equipped with an auto restart function. When the power supply is cut off during operation, such as during blackouts, the function automatically starts operation in the previous setting once the power supply is resumed. (Refer to the operating instructions for details.)

#### Caution:

- After test run or remote signal reception check, turn off the unit with the E.O. SW or the remote controller before turning off the power supply. If this procedure is not performed, the unit will automatically begin operation when power supply is resumed.

#### To the user

- After installing the unit, explain to the user about auto restart function.
- If auto restart function is unnecessary, it can be deactivated. Consult the service representative to deactivate the function. Refer to the service manual for details.

### 4-4. EXPLANATION TO THE USER

- Using the OPERATING INSTRUCTIONS, explain to the user how to use the air conditioner (the remote controller, removing the air filters, placing or removing the remote controller from the remote controller holder, cleaning methods, precautions for operation, etc.)
- Recommend that the user read the OPERATING INSTRUCTIONS carefully.

## 5. RELOCATION AND MAINTENANCE

### 5-1. REMOVING AND INSTALLING THE PANEL ASSEMBLY

#### Removal procedure (Fig. 1)

- 1) Remove the two screws that attach the panel assembly.
- 2) Remove the panel assembly. Be sure to remove its bottom end first.

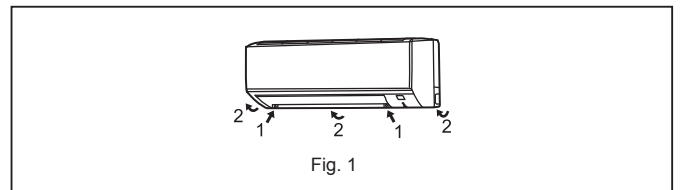

#### Installation procedure (Fig. 2)

- 1) Install the panel assembly following the removal procedure in reverse.
- 2) Be sure to press the positions as indicated by the arrows in order to attach the assembly completely to the unit.

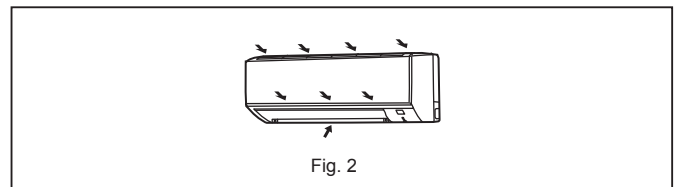



## 5-2. REMOVING THE INDOOR UNIT

Remove the bottom of the indoor unit from the installation plate.  
When releasing the corner part, release both left and right bottom corner part of indoor unit and pull it downward and forward as shown in the figure on the right.

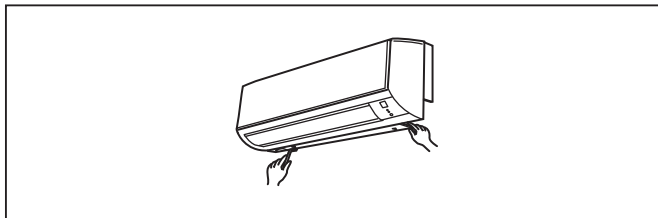

### If the above method cannot be used

Remove the front panel. Then, insert hexagonal wrenches into the square holes on the left and right sides of the unit and push them up as shown in the following figure. The bottom of the indoor unit lowers and releases the hooks.

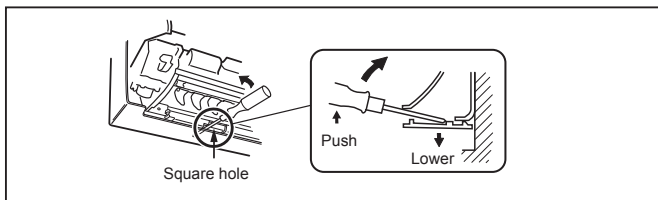

## 5-3. PUMPING DOWN

When relocating or disposing of the air conditioner, pump down the system following the procedure below so that refrigerant is not released into the atmosphere.

- 1) Connect the gauge manifold valve to the service port of the stop valve on the gas pipe side of the outdoor unit.
- 2) Fully close the stop valve on the liquid pipe side of the outdoor unit.
- 3) Close the stop valve on the gas pipe side of the outdoor unit almost completely so that it can be easily closed fully when the pressure gauge shows 0 psi [Gauge] (0 Mpa).
- 4) Start the emergency COOL operation.

To start the emergency operation in COOL mode, disconnect the power supply plug and/or turn off the breaker. After 15 seconds, connect the power supply plug and/or turn on the breaker, and then press the E.O. SW once. (The emergency COOL operation can be performed continuously for up to 30 minutes.)

- 5) Fully close the stop valve on the gas pipe side of the outdoor unit when the pressure gauge shows (0.1 to 0 psi [Gauge] (0.05 to 0 Mpa)).
- 6) Stop the emergency COOL operation.

To stop operation, press the E.O. SW several times until all LED lamps turn off. Refer to operating instructions for details.

### ⚠ WARNING

When the refrigeration circuit has a leak, do not execute pump down with the compressor.  
When pumping down the refrigerant, stop the compressor before disconnecting the refrigerant pipes. The compressor may burst if air etc. get into it.

## 6. CONNECTING THE INTERFACE/CONNECTOR CABLE TO THE AIR CONDITIONER

- Connect the INTERFACE/CONNECTOR CABLE to the Indoor electronic control P.C. board of the air conditioner with the connecting cable.
- Cutting or extending the connecting cable of the INTERFACE/CONNECTOR CABLE results in defects in connecting.  
Do not bundle the connecting cable together with power supply cord, indoor/outdoor connecting wire, and/or earth wire. Keep as much distance as possible between the connecting cable and those wires.
- The thin part of the connecting cable should be stored and placed where customers cannot touch it.

### Connecting

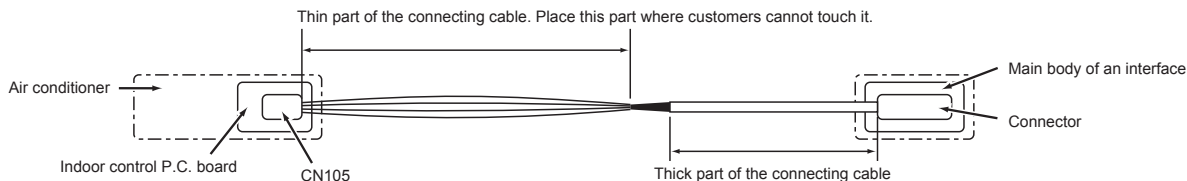

- (1) Remove the panel and the lower right corner box.

- (2) Open the cover of the indoor control P.C. board.

- (3) Join the connecting cable to CN105 connector.

- (4) Hook the connecting cable as shown in the figure.

- (5) Attach the cable clamp provided with an interface to the thick part of the connecting cable with a screw 4×16 as shown in the figure.

- (6) Close the cover of the indoor control P.C. board. Be careful not to catch the thin part of the connecting cable in the cover. Reinstall the panel and the lower right corner box.

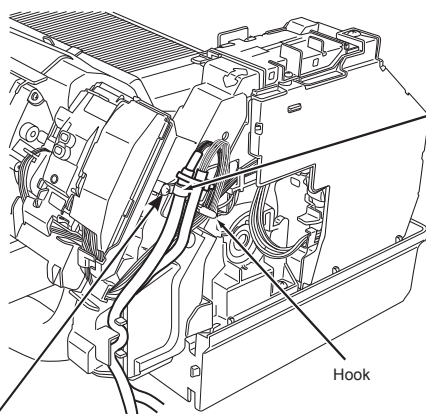
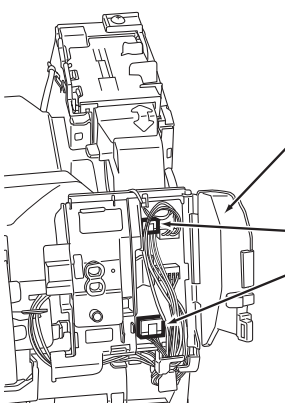

In case of simultaneous connection of CN24 and CN105

Clamp to CN105 and fix it with a screw.

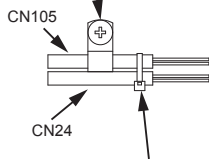

Bundle CN105 and CN24 cables with Cable tie.

### ⚠ WARNING

Fix the connecting cable at the prescribed position securely. Incorrect installation may cause electric shock, fire, and/or malfunction.

## MITSUBISHI ELECTRIC CORPORATION

HEAD OFFICE: TOKYO BUILDING, 2-7-3, MARUNOUCHI, CHIYODA-KU, TOKYO 100-8310, JAPAN



SPLIT-TYPE AIR CONDITIONERS  
**INSTALLATION MANUAL**

DG79A04VH01

**MSZ-GS06/09/12/15NA**  
**MSY-GS09/12/15NA**

When installing multi units, refer to the installation manual of the multi unit for outdoor unit installation.

**Required Tools for Installation**

Phillips screwdriver	5/32 in. (4 mm) hexagonal wrench
Level	Flare tool for R410A
Scale	Gauge manifold for R410A
Utility knife or scissors	Vacuum pump for R410A
3 in. (75 mm) hole saw	Charge hose for R410A
Torque wrench	Pipe cutter with reamer
Wrench (or spanner)	

## 1. BEFORE INSTALLATION

### 1-1. THE FOLLOWING SHOULD ALWAYS BE OBSERVED FOR SAFETY

- Be sure to read these safety precautions and instructions.
- Be sure to observe the warnings and cautions specified here.
- After reading this manual, be sure to store it with the OPERATING INSTRUCTIONS for future reference.
- Please report to your supply authority or obtain their consent before connecting this equipment to the power supply system.

#### **⚠ WARNING** (Could lead to death or serious injury.)

- **Do not install the unit by yourself (user).**  
Improper or incomplete installation could cause fire, electric shock, injury due to the unit falling, or water leakage. Consult a qualified installer or the dealer from whom you purchased the unit.
- **Follow the instructions detailed in the installation manual.**  
Incomplete installation could cause fire or electric shock, injury due to the unit falling, or leakage of water.
- **When installing the unit, use appropriate protective equipment and tools for safety.**  
Failure to do so could cause injury.
- **Install the unit securely in a place that can bear the weight of the unit.**  
If the installation location cannot bear the weight of the unit, the unit could fall causing injury.
- **Do not alter the unit.**  
It may cause fire, electric shock, injury or water leakage.
- **Perform electrical work according to the installation manual and be sure to use an exclusive circuit. Do not connect other electrical appliances to the circuit.**  
If the capacity of the power circuit is insufficient or there is incomplete electrical work, it could result in a fire or an electric shock.
- **Ground the unit correctly.**  
Do not connect the ground wire to a gas pipe, water pipe, lightning rod or telephone ground. Defective grounding could cause electric shock.
- **Do not damage the wires.**  
Damaged wires could cause fire.
- **Be sure to shut off the main power when setting up the indoor P.C. board or wiring.**  
Failure to do so could cause electric shock.
- **Use the specified wires to securely connect the indoor and outdoor units. Attach the wires firmly to avoid applying stress to the terminal block.**  
Improper connection could cause fire.
- **Do not install the unit in a place where flammable gas may leak.**  
If gas leaks and accumulates around the unit, it could cause an explosion.
- **Do not use intermediate connection of the power cord or the extension cord. Do not connect many devices to one AC outlet.**  
It could cause a fire or an electric shock.
- **Use the parts provided or specified parts for the installation work.**  
The use of defective parts could cause an injury or leakage of water due to a fire, an electric shock, the unit falling, etc.
- **When plugging the power supply plug into the outlet, make sure that there is no dust, blockage, or loose parts both in the outlet and on the plug. Verify that the power supply plug is completely in the outlet.**  
If there is dust, blockage, or loose parts on the power supply plug or the outlet, it could cause electric shock or fire. If loose parts are found on the power supply plug, replace it.
- **Securely attach the electrical cover to the indoor unit and the service panel to the outdoor unit.**  
If the electrical cover of the indoor unit and/or the service panel of the outdoor unit are not attached securely, dust, water, etc. could collect in the unit and could cause a fire or an electric shock.
- **When installing, relocating, or servicing the unit, make sure that no substance other than the specified refrigerant (R410A) enters the refrigerant circuit.**  
Any presence of foreign substance such as air can cause abnormal pressure rise and may result in explosion or injury. The use of any refrigerant other than that specified for the system will cause mechanical failure, system malfunction, or unit breakdown. In the worst case, this could lead to a serious impediment to securing product safety.
- **Do not discharge the refrigerant into the atmosphere. Check that the refrigerant gas does not leak after installation has been completed. If refrigerant leaks during installation, ventilate the room.**  
If refrigerant comes in contact with a fire, harmful gas could be generated. If refrigerant gas leaks indoors, and comes into contact with the flame of a fan heater, space heater, stove, etc., harmful gases will be generated.
- **Use appropriate tools and piping materials for installation.**  
The pressure of R410A is 1.6 times higher than R22. Not using the appropriate tools and materials, or improper installation could cause the pipes to burst causing an injury.
- **When pumping down the refrigerant, stop the compressor before disconnecting the refrigerant pipes.**  
If the refrigerant pipes are disconnected while the compressor is running and the stop valve is open, air could be drawn in and the pressure in the refrigeration cycle could become abnormally high, causing the pipes to burst.
- **When installing the unit, securely connect the refrigerant pipes before starting the compressor.**  
If the compressor is started before the refrigerant pipes are connected and the stop valve is open, air could be drawn in and the pressure in the refrigeration cycle could become abnormally high, causing the pipes to burst.
- **Fasten a flare nut with a torque wrench as specified in this manual.**  
If fastened too tight, a flare nut could break and cause refrigerant leakage.
- **Install the unit according to national wiring regulations.**
- **When opening or closing the valve below freezing temperatures, refrigerant may spurt out from the gap between the valve stem and the valve body, resulting in injuries.**

#### **⚠ CAUTION** (Could lead to serious injury when operated incorrectly.)

- **Depending on the installation area, install a Ground Fault Interrupt (GFI) circuit breaker.**  
If the Ground Fault Interrupt (GFI) circuit breaker is not installed, an electric shock could occur.
- **Perform the drainage/piping work securely according to the installation manual.**  
If there is defect in the drainage/piping work, water could drip from the unit, and damage household items.
- **Do not touch the air inlet or the aluminum fins of the outdoor unit.**  
This could cause injury.
- **Do not install the outdoor unit where small animals may live.**  
If small animals enter the unit and damage its electrical parts, it could cause a malfunction, smoke emission, or fire. Keep the area around the unit clean.

## 1-2. SELECTING THE INSTALLATION LOCATION

### INDOOR UNIT

- Where airflow is not blocked.
- Where cool (or warm) air spreads over the entire room.
- On a rigid wall to reduce the possibility of vibration.
- Where it is not exposed to direct sunlight. Do not expose to direct sunlight also during the period following unpacking to before use.
- Where it can be easily drained.
- At a distance 3 ft. (1 m) or more away from a TV and radio. Operation of the air conditioner may interfere with radio or TV reception. An amplifier may be required for the affected device.
- In a place as far away as possible from fluorescent and incandescent lights (so the infrared remote control can operate the air conditioner normally).
- Where the air filter can be removed and replaced easily.
- Where it is away from the other heat or steam source.

#### Note:

Install the indoor unit high on the wall where air can distribute over the entire room.

### REMOTE CONTROLLER

- Where it is convenient to operate and easily visible.
- Where children cannot easily touch it.
- Select a position about 4 ft. (1.2 m) above the floor. Check that signals from the remote controller from that position are received by the indoor unit ('beep' or 'beep beep' receiving tone sounds). Then, attach remote controller holder to a pillar or wall and install wireless remote controller.

#### Note:

In rooms where inverter type fluorescent lamps are used, the signal from the wireless remote controller may not be received.

### OUTDOOR UNIT

- Where it is not overly exposed to strong winds. If the outdoor unit is exposed to a wind during defrosting, the defrosting time will be longer.
- Where airflow is good and dustless.
- Where neighbours are not annoyed by operation sound or hot (or cool) air.
- Where rigid wall or support is available to prevent the increase of operation sound or vibration.
- Where there is no risk of combustible gas leakage.
- If installing the unit in a location high above the ground, be sure to secure the unit legs.
- Where it is at least 10 ft. (3 m) away from the antenna of TV set or radio. Operation of the air conditioner may interfere with radio or TV reception in areas where reception is weak. An amplifier may be required for the affected device.
- Install the unit horizontally.
- Please install it in an area not affected by snowfall or blowing snow. In areas with heavy snow, please install a canopy, a pedestal and/or baffle boards.

#### Note:

- It is advisable to make a piping loop near outdoor unit so as to reduce vibration.
- For increased efficiency, install the outdoor unit in a location where continuous direct sunlight or excessive water can be avoided as much as possible.

#### Note:

When operating the air conditioner in low outside temperature, be sure to follow the instructions described below.

- Never install the outdoor unit in a place where its air inlet/outlet side may be exposed directly to wind.
- To prevent exposure to wind, install the outdoor unit with its air inlet side facing the wall and a baffle board on the air outlet side.

Avoid the following places for installation where air conditioner trouble is liable to occur.

- Where flammable gas could leak.
- Where there is an excessive amount of machine oil in the air.
- Where oil is splashed or where the area is filled with oily smoke (such as cooking areas and factories, in which the properties of plastic could be changed and damaged).
- Salty places such as the seaside.
- Where sulfide gas is generated such as hot spring, sewage, waste water.
- Where there is high-frequency or wireless equipment.
- Where there is emission of high levels of VOCs, including phthalate compounds, formaldehyde, etc., which may cause chemical cracking.

## 1-3. SPECIFICATIONS

### 1-3-1. POWER SUPPLY AND INDOOR/OUTDOOR WIRE CONNECTION

- Power should be taken from an exclusive branched circuit.
- Wiring work should be based on applicable technical standards.
- Wiring connections should be made following the diagram.
- Securely tighten screws.

#### Connecting wires and the ground wire

- Use solid conductor Min. AWG14 or stranded conductor Min. AWG14.
- Use double insulated copper wire with 600 V insulation.
- Use copper supply wire.
- \* Follow local electrical codes.

#### Power supply cable and ground wire

- Use solid or stranded conductor Min. AWG14.
- Use copper supply wire.
- \* Follow local electrical codes.

#### Note:

When the indoor unit is powered from the outdoor unit, depending on local code, a disconnect switch needs to be installed to a power supply circuit.

### Electrical specifications

MODEL	INDOOR	MSZ-GS06NA	MSZ-GS09NA MSY-GS09NA		MSZ-GS12NA MSY-GS12NA		MSZ-GS15NA MSY-GS15NA		
	OUTDOOR	-	MUZ-GS09NA(H) MUY-GS09NA	MUZ-GS09NAHZ	MUZ-G12NA(H) MUY-GS12NA	MUZ-GS12NAHZ	MUZ-G15NA(H) MUY-GS15NA	MUZ-GS15NAHZ	
<b>INDOOR UNIT</b>									
Power supply (V, PHASE, Hz)		208/230, 1, 60							
Min. Circuit Ampacity (A)		1.0							
Fan motor (F.L.A.) (A)		0.75							
<b>OUTDOOR UNIT</b>									
Power supply (V, PHASE, Hz)		208/230, 1, 60							
Max. Fuse size (time delay) (A)		*	15	15	15	15	15	15	
Min. Circuit Ampacity (A)		*	10	10	10	10	10	10	
Fan motor (F.L.A.) (A)		*	0.50	0.50	0.50	0.50	0.50	0.50	
Compressor	(R.L.A) (A)	MSZ	*	6.7	6.7	6.7	7.4	7.4	7.4
		MSY	*	6.7	-	6.7	-	7.4	-
	(L.R.A) (A)	MSZ	*	8.4	8.4	8.4	9.2	9.2	9.2
		MSY	*	8.4	-	8.4	-	9.2	-
Control voltage		Indoor unit - Remote controller: (Wireless) Indoor unit - Outdoor unit: DC12-24 V (Polar)							

\* MSZ-GS06NA is a dedicated indoor unit for multi system. Refer to the installation manual of the multi unit for details.

### 1-3-2. REFRIGERANT PIPES

- To prevent condensation, insulate the two refrigerant pipes.



#### CAUTION

Be sure to use the insulation of specified thickness (table on the right). Excessive insulation may cause incorrect installation of the indoor unit, and too little insulation may cause condensate to form.

- Refrigerant pipe bending radius must be 4 in. (100 mm) or more.
- The unit has flared connections on both indoor and outdoor sides.
- Remove the valve cover from the outdoor unit, then connect the pipe.
- Refrigerant pipes are used to connect the indoor and outdoor units.
- Be careful not to crush or over bend the pipe in pipe bending.
- Refrigerant adjustment... If pipe length exceeds 25 ft. (7.5 m), additional refrigerant (R410A) charge is required. (The outdoor unit is charged with refrigerant for pipe length up to 25 ft. [7.5 m])
- Please carefully consider the indoor unit location when piping lengths are less than 16 ft. (5 m) as there could be intermittent noises during normal operation that would be noticeable in very quiet environments.

Pipe	Outside diameter	Minimum wall thickness	Insulation thickness	Insulation material
	inch (mm)			
For liquid	1/4 (6.35)	0.0315 (0.8)	5/16 (8)	Heat resistant foam plastic 0.045 Specific gravity
For gas	3/8 (9.52)	0.0315 (0.8)	5/16 (8)	
		1/2 (12.7)	0.0315 (0.8)	5/16 (8)

Limits		
Pipe length	MSZ/MSY-GS09/12/15NA	65 ft. (20 m) max.
Height difference	MSZ/MSY-GS09/12/15NA	40 ft. (12 m) max.
No. of bends		10 max.

Pipe length	Up to 25 ft. (7.5 m)	No additional charge is required.
	Exceeding 25 ft. (7.5 m)	Additional charge is required. (Refer to the table below.)
Refrigerant to be added	MSZ/MSY-GS09/12/15NA	1.08 oz each 5 ft. (20 g/m)

# 1-4. INSTALLATION DIAGRAM

## ACCESSORIES

Check the following parts before installation.  
<Indoor unit>

(1)	Installation plate	1
(2)	Attachment screws for the installation plate 4 × 25 mm	5
(3)	Wireless remote controller	1
(4)	Felt tape (For left or left-rear piping)	1
(5)	Remote controller holder	1
(6)	Screws for the remote controller holder 3.5 × 16 mm (Black)	2
(7)	Battery (AAA) for (3)	2
(8)	Air cleaning filter	2

## FIELD-SUPPLIED PARTS

(A)	Indoor/outdoor unit connecting wire*1	1
(B)	Extension pipe	1
(C)	Wall hole sleeve	1
(D)	Wall hole cover	1
(E)	Pipe attachment strap	2 to 5
(F)	Screw for (E) 4 × 20 mm	2 to 5
(G)	Piping tape	1
(H)	Putty	1
(I)	Drain hose (or soft PVC hose, 19/32 in. [15 mm] inner diameter or hard PVC pipe VP16)	2 to 5
(J)	Refrigerant oil	1
(K)	Power supply cord*1	1

### Note:

\*1 Place indoor/outdoor unit connecting wire (A) and power supply cord (K) at least 3 ft. (1 m) away from the TV antenna wire.

\*2 4 in. (100 mm) or more when front and sides of unit are clear

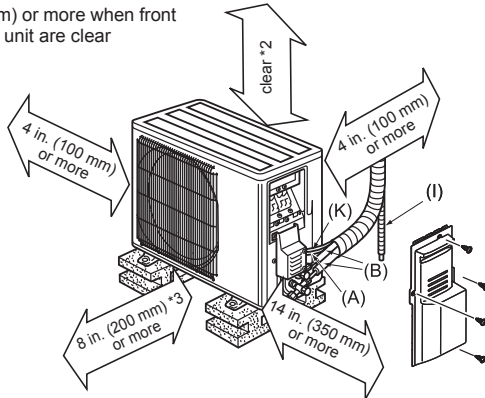

\*3 When any 2 sides of left, right and rear of unit are clear

Units should be installed by licensed contractor according to local code requirements.

### Note:

- The dimensions indicated in the arrows (↔) above show the required space to guarantee performance of the air conditioner. Install the outdoor unit where the maximum possible space can be provided, considering later relocation, services, or repairs.
- The cooling/heating performance and the efficiency of power usage may fall about 10% at the place where short cycle is likely occur due to poor ventilation. Installing the air outlet guide (optional) can improve performances.
- If air from the outlet blows against the wall, it may cause stains on the wall.



Do not take in the outlet air discharged by other units directly.

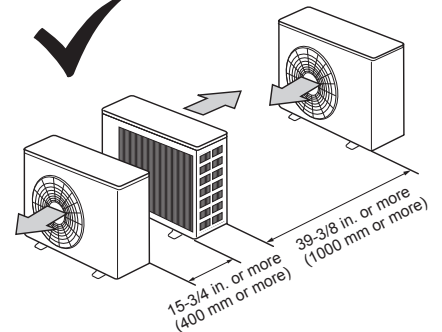
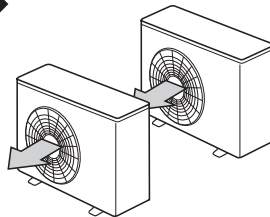

Use the wall hole sleeve (C) to prevent indoor/outdoor connecting wire (A) from contacting metal parts in the wall and to protect the wiring from rodents.

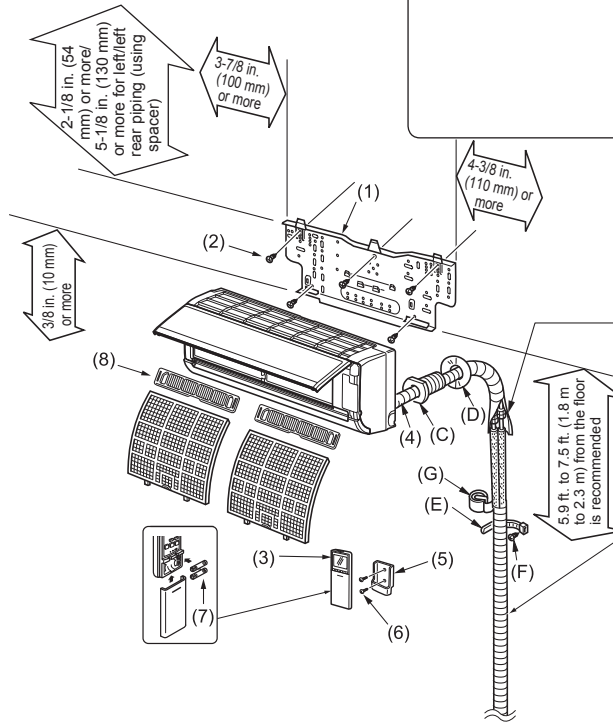
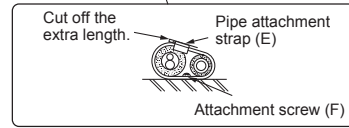
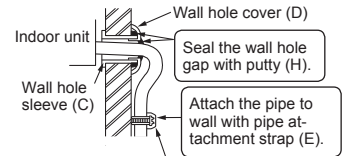

After the leak test, apply insulating material tightly so that there is no gap.

When the piping is to be attached to a wall comprised of tin plate or metal netting, use chemically treated wooden piece 25/32 in. (20 mm) or thicker between the wall and the piping, or wrap insulation vinyl tape 7 to 8 turns around the piping.  
To use existing piping, perform COOL operation for 30 minutes and pump down before removing the old air conditioner. Remake flare according to the dimension for new refrigerant.

Unit: inch

Unit: mm

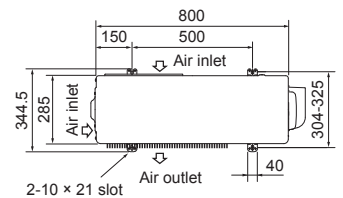
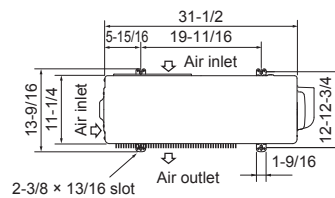

### Drain piping for outdoor unit

Install the unit horizontally.

Do not use drain socket in cold regions. Drain may freeze and make the fan stop.

The outdoor unit produces condensate during the heating operation. Select the installation place to ensure to prevent the outdoor unit and/or the grounds from being wet by drain water or damaged by frozen drain water.

## 2. INDOOR UNIT INSTALLATION

### 2-1. ATTACHING THE INSTALLATION PLATE

- Find a stud in the wall to attach installation plate (1) horizontally by tightening the fixing screws (2) firmly.
- To prevent installation plate (1) from vibrating, be sure to install the attachment screws in the holes indicated in the illustration. For added support, additional screws may also be installed in other holes.
- When the indoor unit is to be attached to a concrete wall using recessed bolts, secure installation plate (1) using 7/16 in. x 13/16 in. · 7/16 in. x 1 in. (11 mm x 20 mm · 11 mm x 26 mm) oval hole (17-3/4 in. [450 mm] pitch).
- If the recessed bolt is too long, change it for a shorter one (field-supplied).

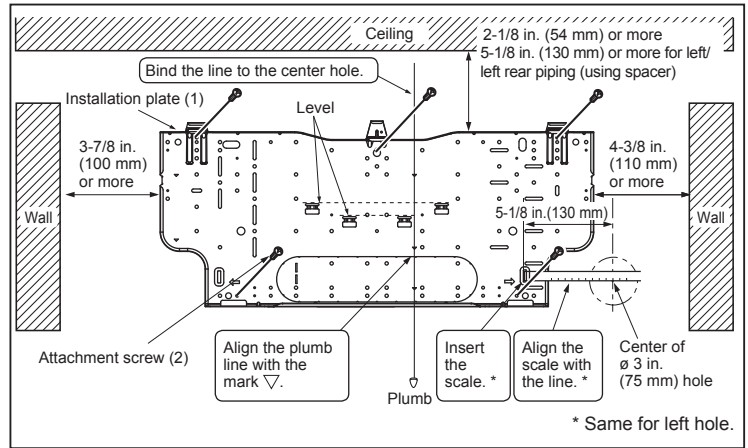

### 2-2. DRILLING

- 1) Determine where the holes will be located on the wall.
- 2) Drill a ø 3 in. (75 mm) hole. The outdoor side should be 6/32 to 9/32 in. (5 to 7 mm) lower than the indoor side.
- 3) Insert wall hole sleeve (C).

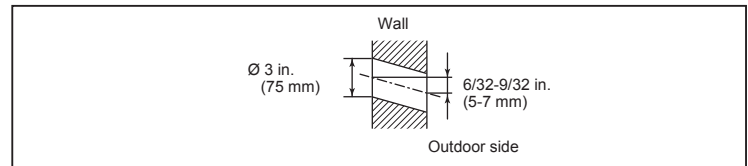

### 2-3. CONNECTING WIRES FOR INDOOR UNIT

#### Note:

When the indoor unit is powered from the outdoor unit, depending on local code, a disconnect switch needs to be installed to a power supply circuit.

- 1) Remove the panel assembly. (Refer to 5-1.)
- 2) Place the upper part of the indoor unit on the installation plate.
- 3) Remove corner box and electrical cover.
- 4) Remove display panel, conduit cover and conduit plate.
- 5) Attach conduit pipe (for rear piping) / elbow joint (for right, left, or downward piping) to conduit plate with lock nut. The thread of the installed conduit pipe / elbow joint appearing inside should be less than 3/8 in. (10 mm). (Fig. 1) Elbow joint should appear less than 1-3/16 in. (30 mm) outside. (Fig. 2)
- 6) Process the end of ground wire (Fig. 3). Connect it to the ground terminal of electrical parts box.
- 7) Process the end of indoor/outdoor unit connecting wire (A) (Fig. 3). Attach it to the terminal block. Be careful not to make mis-wiring. Attach the wire to the terminal block securely so that its core cannot be seen, and no external force affects the connecting section of the terminal block.
- 8) Firmly tighten the terminal screws. After tightening, verify that the wires are tightly fastened.
- 9) Reinstall conduit plate, conduit cover and display panel.
- 10) According to the piping direction, remove the shaded part of the left side of box (Fig. 4) or corner box (Fig. 5). Reinstall electrical cover, corner box and front panel.

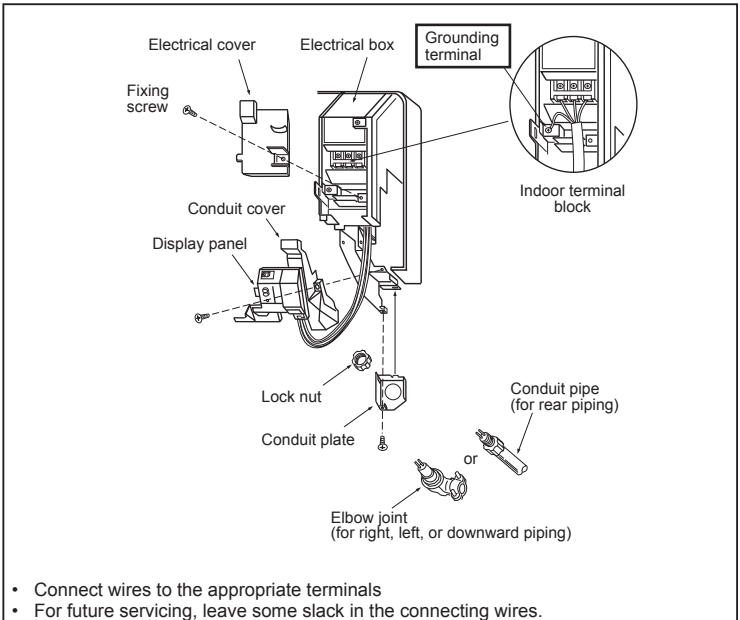

#### Remark:

- \* A disconnect switch should be required. Check the local code.
- \*\* Use a ring tongue terminal in order to connect a ground wire to terminal.

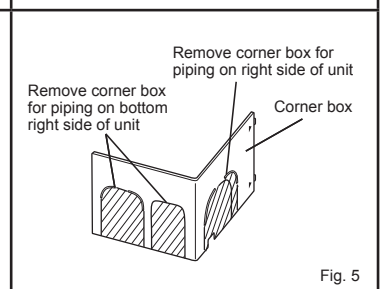
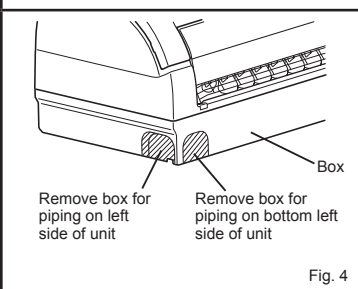
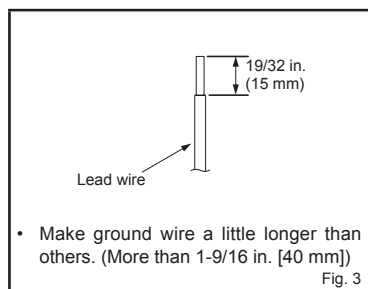
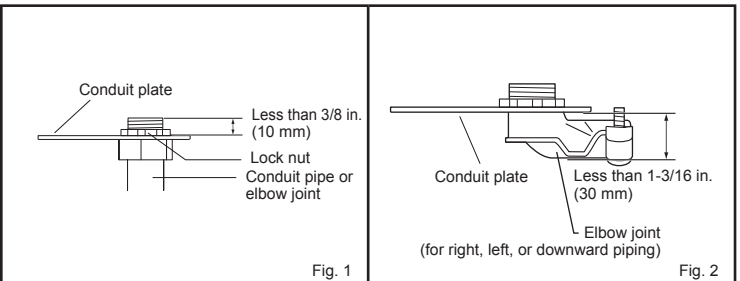
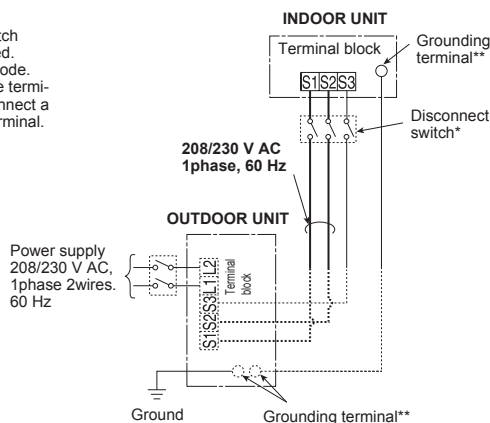

## 2-4. PIPE FORMING AND DRAIN PIPING

### 2-4-1. PIPE FORMING

- Place the drain hose below the refrigerant piping.
- Make sure that the drain hose is not crowded or bent.
- Do not pull the hose when applying the tape.
- When the drain hose passes the room, be sure to wrap it with insulation material (field-supplied).

**Note:**  
Make sure not to damage the cover of refrigerant pipe when attaching it back on with screws.

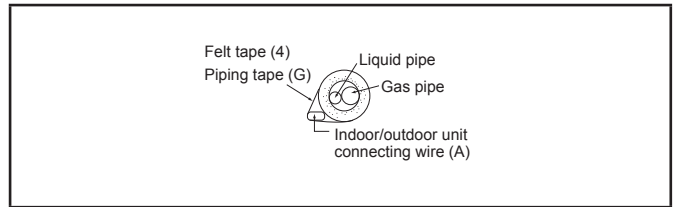

### Left or left-rear piping

**Note:**  
Be sure to reattach the drain hose and the drain cap if the piping is being installed on left or left-rear of unit, otherwise, water could drip down from the drain hose.

- Place the refrigerant piping and the drain hose together, then firmly apply felt tape (4) from the end.  
Felt tape (4) overlap width should be 1/3 the tape width. Use a bandage stopper at the end of felt tape (4).
- Pull out the drain cap at the back right of the indoor unit. (Fig. 1)
  - Hold the convex section at the end and pull the drain cap.
- Pull out the drain hose at the back left of the indoor unit. (Fig. 2)
  - Hold the claw marked by the arrows and pull out the drain hose forward.
- Put the drain cap into the section to which the drain hose is to be attached at the rear of the indoor unit. (Fig. 3)
  - Insert a screwdriver into the hole on the cap and insert the cap fully into the drain pan.
- Insert the drain hose fully into the drain pan at the back right of the indoor unit. (Fig. 4)
  - Check if the hose is hooked securely to the projection of its inserting part at the drain pan.
- Insert the drain hose into wall hole sleeve (C), and attach the upper part of indoor unit onto the installation plate (1). Then, shift the indoor unit completely to the left to make placing the piping in the back of the unit easier.
- Cut out a piece of cardboard from the shipping box, roll it up, hook it onto the back rib, and use it as a spacer to lift the indoor unit. (Fig. 5)
- Connect the refrigerant piping with the extension pipe (B).
- Attach the lower part of the indoor unit into the installation plate (1).

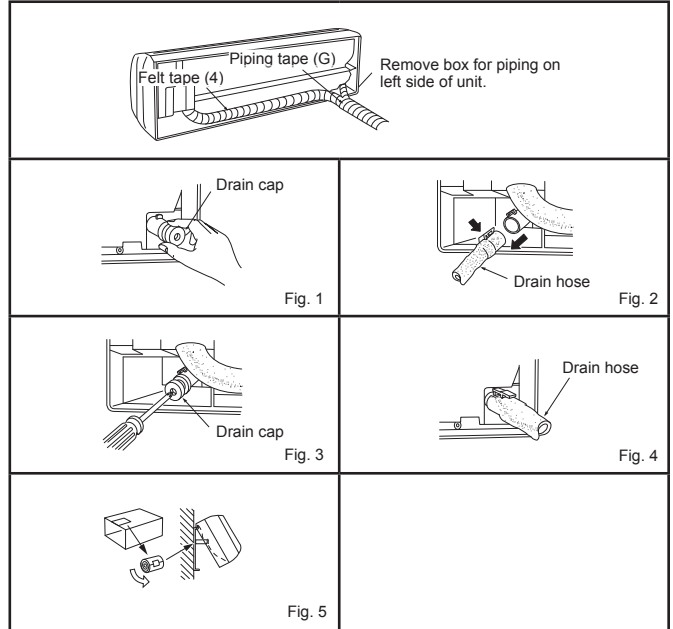

### Rear or bottom piping

- Place the refrigerant piping and the drain hose together, then firmly apply piping tape (G) from the end.
- Insert the piping and the drain hose into the wall hole sleeve (C), and attach the upper part of the indoor unit on the installation plate (1).
- Check if the indoor unit is attached securely on the installation plate (1) by moving the unit to left and right.
- Attach the lower part of the indoor unit into the installation plate (1).

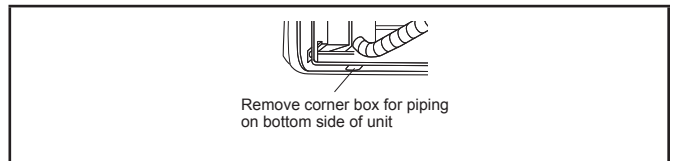

### Right piping

- Note:**  
Before performing the following, make sure that wiring is completed, and the conduit cover is installed. (Refer to 2-3.)
- Place the refrigerant piping and the drain hose together, shift them to left side of the unit, and then firmly apply piping tape (G) from the end.
  - Insert the piping and the drain hose into the wall hole sleeve (C), and attach the upper part of the indoor unit on the installation plate (1).
  - Check if the indoor unit is attached securely on the installation plate (1) by moving the unit to left and right.
  - Attach the lower part of the indoor unit into the installation plate (1).

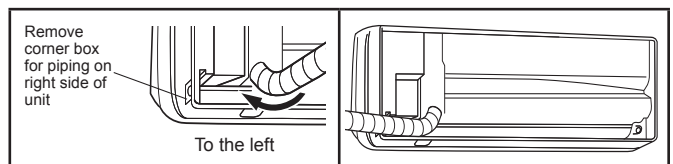

### 2-4-2. DRAIN PIPING

- If the extension drain hose has to pass through a room, be sure to wrap it with insulation (field-supplied).
- The drain hose should point downward for easy drain. (Fig. 1)
- If the drain hose provided with the indoor unit is too short, connect it with a field-supplied drain hose (I). (Fig. 2)
- When connecting the drain hose to a hard vinyl chloride pipe, be sure to insert it securely into the pipe. (Fig. 3)

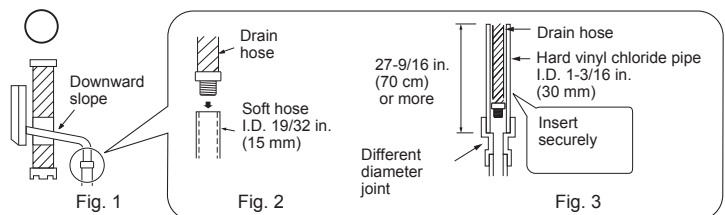

Do not put the drain pipe directly in a drainage ditch where Ammonia or Sulphuric gas may be generated. The evaporated corrosive gas may return to the indoor side through drain pipe and this may cause an unpleasant odor and corrosion on Heat exchanger may occur.

Do not make drain piping as shown below.

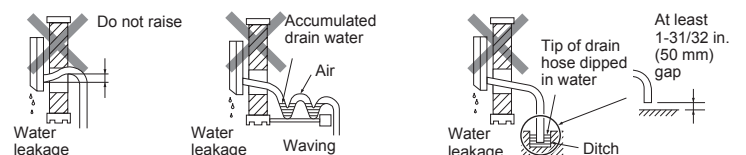

### 3. OUTDOOR UNIT INSTALLATION

#### 3-1. CONNECTING WIRES FOR OUTDOOR UNIT

- 1) Remove the service panel.
- 2) Remove the conduit cover.
- 3) Attach the conduit connectors to the conduit plate with lock nuts then secure it against unit with screws.
- 4) Connect the ground wires of indoor/outdoor unit connecting wire (A) and power supply cord (K) to the TB support.
- 5) Loosen the terminal screws, then attach indoor/outdoor unit connecting wire (A) and power supply cord (K) from the indoor unit correctly to the terminal block. Attach the wires to the terminal block securely so that the cores cannot be seen, and no external force affects the connecting section of the terminal block.
- 6) Firmly tighten the terminal screws. After tightening, verify that the wires are tightly fastened.
- 7) Install the conduit cover.
- 8) Install the service panel securely.

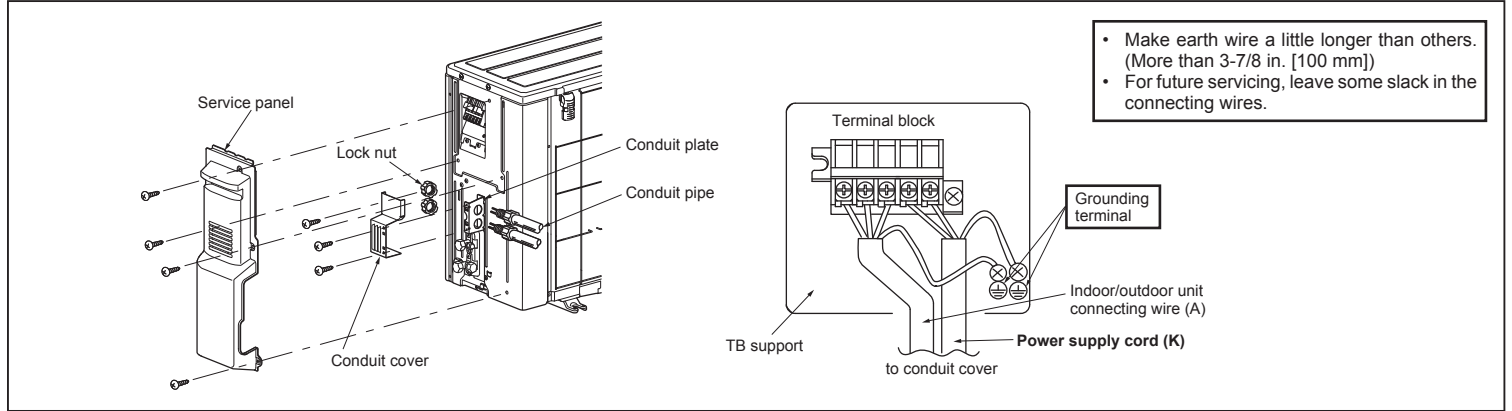
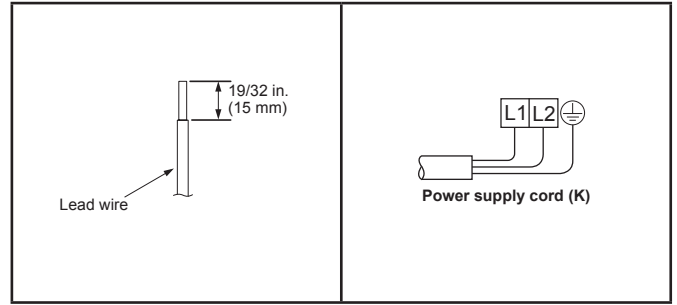

#### 3-2. FLARE CONNECTION

- 1) Cut the copper pipe as straight as possible with a pipe cutter. (Fig. 1, 2)
- 2) Remove all burrs from the cut section of the pipe, ensuring that precautions are taken to avoid getting metal shavings into the piping. (Fig. 3)
- 3) Remove flare nuts attached to indoor and outdoor units, then put them on pipe.
- 4) Flaring work (Fig. 4, 5). Firmly hold copper pipe in the dimension shown in the table. Select A inch (mm) from the table according to the tool you use.
- 5) Check
  - Compare the flared work with Fig. 6.
  - If flare is defective, cut off the section and repeat procedure.

Pipe diameter inch (mm)	B inch (mm)	A inch (mm)			Tightening torque	
		Clutch type tool for R410A	Clutch type tool for R22	Wing nut type tool for R22	ft-lb (kgf·cm)	N·m
ø 1/4 (6.35)	21/32 (17)	0 to 0.02 (0 to 0.5)	0.04 to 0.06 (1.0 to 1.5)	0.06 to 0.08 (1.5 to 2.0)	10 to 13 (140 to 180)	13.7 to 17.7
ø 3/8 (9.52)	7/8 (22)			0.08 to 0.10 (2.0 to 2.5)	25 to 30 (350 to 420)	34.3 to 41.2
ø 1/2 (12.7)	1-1/32 (26)			36 to 42 (500 to 575)	49.0 to 56.4	
ø 5/8 (15.88)	1-5/32 (29)			54 to 58 (750 to 800)	73.5 to 78.4	

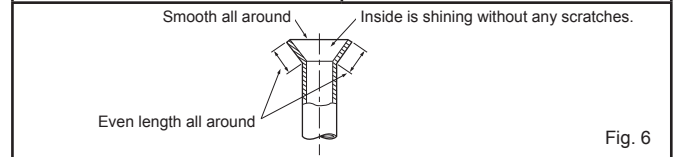
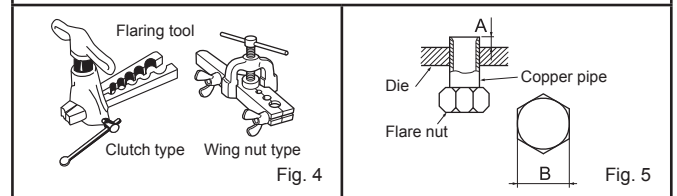
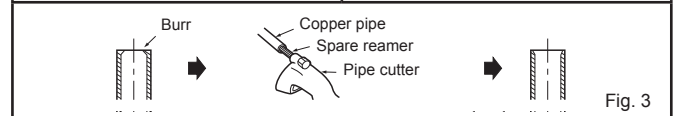
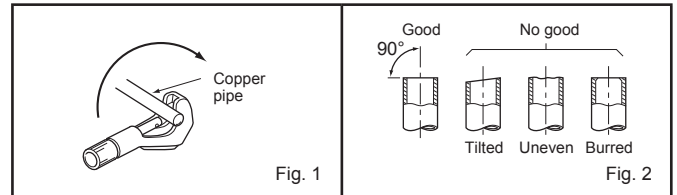

#### 3-3. PIPE CONNECTION

- Fasten flare nut with a torque wrench as specified in the table (refer to 3-2).
- When fastened too tight, flare nut may eventually break and cause refrigerant leakage.
- Be sure to wrap insulation around the piping. Direct contact with the bare piping may result in burns or frostbite.

##### Indoor unit connection

Connect both liquid and gas pipings to indoor unit.

- Apply a thin coat of refrigeration oil (J) on the flared ends of the pipes. Do not apply refrigeration oil on screw threads. Excessive tightening torque will result in damage on the screw.
- To connect, first align the center, then tighten the first 3 to 4 turns of flare nut by hand.
- Use tightening torque table above as a guideline for indoor unit side joints, and tighten using two wrenches. Excessive tightening damages the flare section.

##### Outdoor unit connection

Connect pipes to stop valve pipe joint of the outdoor unit following the same procedure detailed in Indoor unit connection.

- For tightening, use a torque wrench or spanner.

#### ⚠ WARNING

**When installing the unit, securely connect the refrigerant pipes before starting the compressor.**

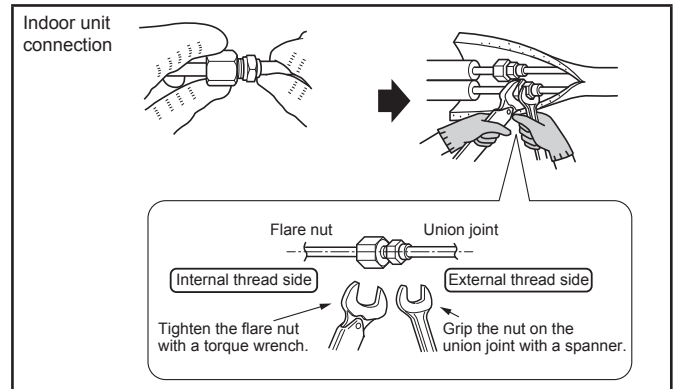

#### 3-4. INSULATION AND TAPING

- 1) Cover piping joints with pipe cover.
- 2) For outdoor unit side, insulate the piping, including valves.
- 3) Apply piping tape (G) starting from the connection on the outdoor unit.
  - When piping has to be installed through a ceiling, closet or where the temperature and humidity are high, use additional field-supplied insulation to prevent condensation.

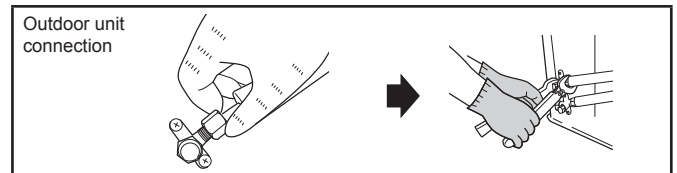

## 4. PURGING PROCEDURES, LEAK TEST, AND TEST RUN

### 4-1. PURGING PROCEDURES AND LEAK TEST

- 1) Remove service port caps from stop valves on both sides of refrigerant lines. (The stop valves are fully closed when shipped.) Leave closed.
- 2) Connect gauge manifold to ports of stop valves.

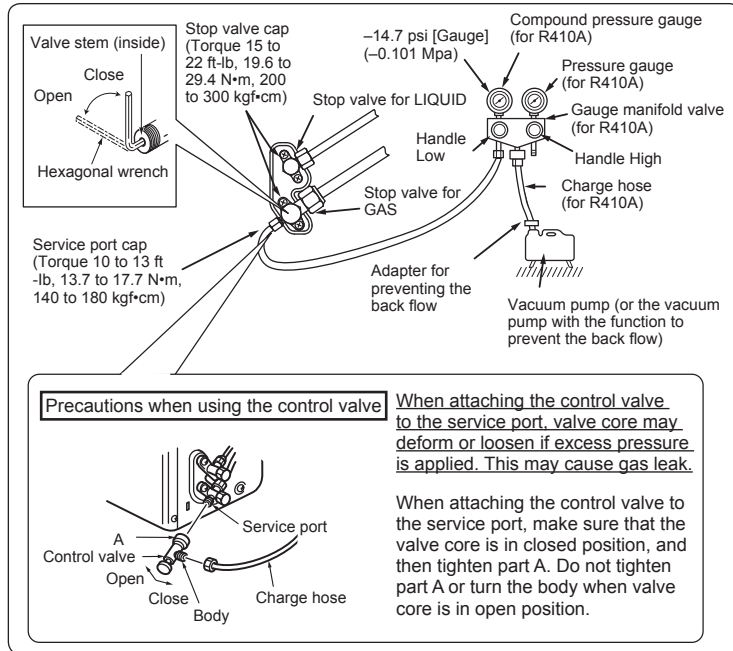

- 3) Evacuate the system to 4000 microns from both service valves. System manifold gauges must not be used to measure vacuum. A micron gauge must be used at all times. Break the vacuum with Nitrogen(N<sub>2</sub>) into the discharge service valve to 0 PSIG.
- 4) Evacuate the system to 1500 microns. Break the vacuum with Nitrogen(N<sub>2</sub>) into the discharge service valve to 0 PSIG.
- 5) Evacuate the system to 500 microns.
- 6) Close gauge manifold valves, stop the pump, and conduct a 30 minute rise test.
- 7) System should hold 500 microns for a minimum of 1 hour.
- 8) Fully open the valve stem of all stop valves on both sides of gas pipe and liquid pipe by the hexagonal wrench. If the valve stem hits the stopper, do not turn it any further. Operating without fully opening lowers the performance and this causes trouble.
- 9) Refer to 1-3 and charge the prescribed amount of additional refrigerant if needed. Be sure to charge slowly with liquid refrigerant. Otherwise composition of the refrigerant in the system may be changed and affect performance of the air conditioner.
- 10) Remove gauge manifolds and replace service port caps and tighten.
- 11) Leak test

### 4-2. TEST RUN

- 1) Insert power supply plug into the power outlet and/or turn on the breaker.
- 2) Press the E.O. SW once for COOL, and twice for HEAT (only MSZ series) operation. Test run will be performed for 30 minutes. If the upper lamp blinks every 0.5 seconds, inspect the indoor/outdoor unit connecting wire (A). After the test run, emergency COOL mode (75°F [24°C] COOL) will start.
- 3) To stop operation, press the E.O. SW several times until all LED lamps turn off. Refer to operating instructions for details.

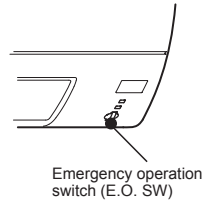

### Checking the remote (infrared) signal reception

Press the OFF/ON button on the remote controller (3) and listen for an audible indicator from the indoor unit. Press the OFF/ON button again to turn the air conditioner off.

- Once the compressor stops, the restart preventive device operates so the compressor will not operate for 3 minutes to protect the air conditioner.

### 4-3. AUTO RESTART FUNCTION

This product is equipped with an auto restart function. When the power supply is cut off during operation, such as during blackouts, the function automatically starts operation in the previous setting once the power supply is resumed. (Refer to the operating instructions for details.)

#### Caution:

- After test run or remote signal reception check, turn off the unit with the E.O. SW or the remote controller before turning off the power supply. If this procedure is not performed, the unit will automatically begin operation when power supply is resumed.

#### To the user

- After installing the unit, explain to the user about auto restart function.
- If auto restart function is unnecessary, it can be deactivated. Consult the service representative to deactivate the function. Refer to the service manual for details.

### 4-4. EXPLANATION TO THE USER

- Using the OPERATING INSTRUCTIONS, explain to the user how to use the air conditioner (the remote controller, removing the air filters, placing or removing the remote controller from the remote controller holder, cleaning methods, precautions for operation, etc.)
- Recommend that the user read the OPERATING INSTRUCTIONS carefully.

## 5. RELOCATION AND MAINTENANCE

### 5-1. REMOVING AND INSTALLING THE PANEL ASSEMBLY

#### Removal procedure (Fig. 1)

- 1) Remove the two screws that attach the panel assembly.
- 2) Remove the panel assembly. Be sure to remove its bottom end first.

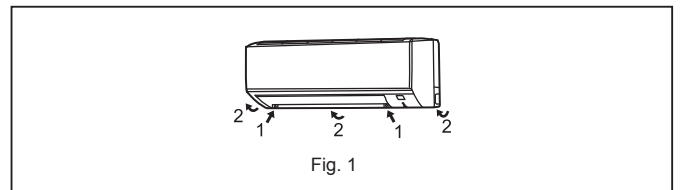

#### Installation procedure (Fig. 2)

- 1) Install the panel assembly following the removal procedure in reverse.
- 2) Be sure to press the positions as indicated by the arrows in order to attach the assembly completely to the unit.

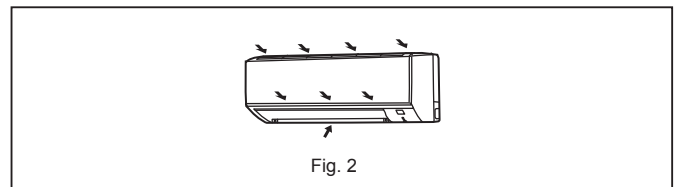



## 5-2. REMOVING THE INDOOR UNIT

Remove the bottom of the indoor unit from the installation plate.  
When releasing the corner part, release both left and right bottom corner part of indoor unit and pull it downward and forward as shown in the figure on the right.

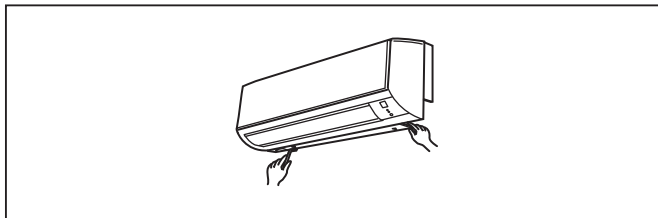

### If the above method cannot be used

Remove the front panel. Then, insert hexagonal wrenches into the square holes on the left and right sides of the unit and push them up as shown in the following figure. The bottom of the indoor unit lowers and releases the hooks.

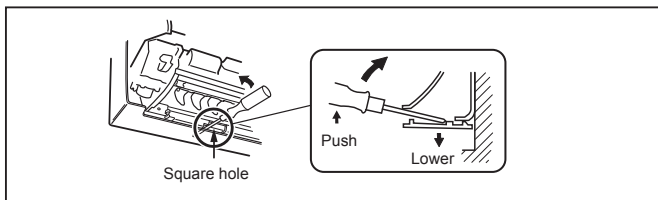

## 5-3. PUMPING DOWN

When relocating or disposing of the air conditioner, pump down the system following the procedure below so that refrigerant is not released into the atmosphere.

- 1) Connect the gauge manifold valve to the service port of the stop valve on the gas pipe side of the outdoor unit.
- 2) Fully close the stop valve on the liquid pipe side of the outdoor unit.
- 3) Close the stop valve on the gas pipe side of the outdoor unit almost completely so that it can be easily closed fully when the pressure gauge shows 0 psi [Gauge] (0 Mpa).
- 4) Start the emergency COOL operation.

To start the emergency operation in COOL mode, disconnect the power supply plug and/or turn off the breaker. After 15 seconds, connect the power supply plug and/or turn on the breaker, and then press the E.O. SW once. (The emergency COOL operation can be performed continuously for up to 30 minutes.)

- 5) Fully close the stop valve on the gas pipe side of the outdoor unit when the pressure gauge shows (0.1 to 0 psi [Gauge] (0.05 to 0 Mpa)).
- 6) Stop the emergency COOL operation.

To stop operation, press the E.O. SW several times until all LED lamps turn off. Refer to operating instructions for details.

### ⚠ WARNING

When the refrigeration circuit has a leak, do not execute pump down with the compressor.  
When pumping down the refrigerant, stop the compressor before disconnecting the refrigerant pipes. The compressor may burst if air etc. get into it.

## 6. CONNECTING THE INTERFACE/CONNECTOR CABLE TO THE AIR CONDITIONER

- Connect the INTERFACE/CONNECTOR CABLE to the Indoor electronic control P.C. board of the air conditioner with the connecting cable.
- Cutting or extending the connecting cable of the INTERFACE/CONNECTOR CABLE results in defects in connecting.  
Do not bundle the connecting cable together with power supply cord, indoor/outdoor connecting wire, and/or earth wire. Keep as much distance as possible between the connecting cable and those wires.
- The thin part of the connecting cable should be stored and placed where customers cannot touch it.

### Connecting

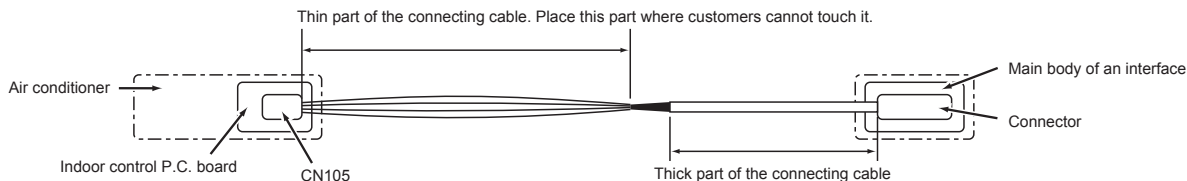

- (1) Remove the panel and the lower right corner box.

- (2) Open the cover of the indoor control P.C. board.

- (3) Join the connecting cable to CN105 connector.

- (4) Hook the connecting cable as shown in the figure.

- (5) Attach the cable clamp provided with an interface to the thick part of the connecting cable with a screw 4×16 as shown in the figure.

- (6) Close the cover of the indoor control P.C. board. Be careful not to catch the thin part of the connecting cable in the cover. Reinstall the panel and the lower right corner box.

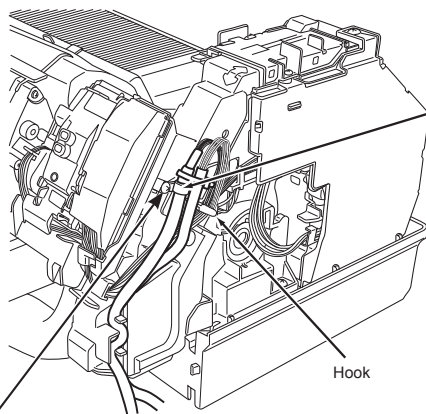
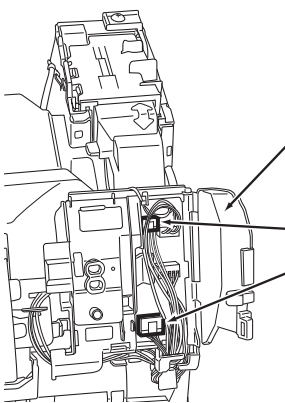

In case of simultaneous connection of CN24 and CN105

Clamp to CN105 and fix it with a screw.

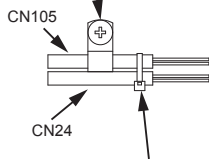

Bundle CN105 and CN24 cables with Cable tie.

### ⚠ WARNING

Fix the connecting cable at the prescribed position securely. Incorrect installation may cause electric shock, fire, and/or malfunction.

## MITSUBISHI ELECTRIC CORPORATION

HEAD OFFICE: TOKYO BUILDING, 2-7-3, MARUNOUCHI, CHIYODA-KU, TOKYO 100-8310, JAPAN