

MSZ-FS09NA 9,000 BTU/H DELUXE WALL MOUNT



Job Name:

System Reference:

Date:



GENERAL FEATURES

- Slim wall-mounted indoor units provide zone comfort control
- Dual Barrier Coating applied to the heat exchanger, vanes and fan to prevent hydrophilic and hydrophobic dirt build-up
- Multiple fan speed options: Quiet, Low, Medium, High, Super-high, Auto
- 3D i-see Sensor® enables advance features:
 - Indirect or Direct Airflow for personalized comfort
 - Absence Detection for energy-saving mode
 - Double Vane features:
 - Separates airflow to deliver air across a large area
 - Simultaneously deliver to air separate sections of a room
 - Generates more comfortable natural airflow pattern
- Multiple control options available:
 - Back-lit screen handheld remote controller (provided with unit)
 - kumo cloud® smart device app for remote access
 - Third-party interface options
 - Wired or wireless controllers
- Triple-action Filtration: Nano Platinum Filter, Deodorizing Filter, & Electrostatic Anti-Allergy Enzyme Filter
- Hot-Start Technology: no cold air rush at equipment startup or when restarting after Defrost Cycle
- Quiet operation

Specifications		System	
Unit Type		MSZ-FS09NA	
Cooling Capacity ^{1,3}		BTU/H	9,000
Heating Capacity ^{2,3}		BTU/H	9,600
Electrical	Voltage, Phase, Frequency		208/230, 1, 60
	Guaranteed Voltage Range	V AC	187- 253V
	Voltage: Indoor - Outdoor, S1-S2	V AC	208/230
	Voltage: Indoor - Outdoor, S2-S3	V DC	24
	Short-circuit Current Rating [SCCR]	kA	5
Indoor Unit	MCA	A	1.0
	Fan Motor Full Load Amperage	A	0.65
	Fan Motor Output	W	40
	Airflow Rate at Cooling, Dry	CFM	137-167-221-304-381
	Airflow Rate at Cooling, Wet	CFM	117-143-190-261-328
	Airflow Rate at Heating, Dry	CFM	140-167-225-325-437
	Sound Pressure Level [Cooling]	dB[A]	20-23-29-36-40
	Sound Pressure Level [Heating]	dB[A]	20-24-29-39-42
	Drain Pipe Size	In. [mm]	5/8 [15.88]
	Coating on Heat Exchanger		Dual Barrier Coating
	External Finish Color		Munsell 1.0Y 9.2/0.2
	Unit Dimensions	W x D x H: In. [mm]	36-7/16 x 9-3/16 x 12 (+11/16) [925 x 234 x 305 (+17)]
	Package Dimensions	W x D x H: In. [mm]	39 x 12-1/4 x 15-1/2 [990 x 310 x 400]
Unit Weight	Lbs. [kg]	29 [13.5]	
Package Weight	Lbs. [kg]	39 x 12-1/4 x 15-1/2 [990 x 310 x 400]	
Refrigerant	Type		R410A
Piping	Gas Pipe Size O.D. [Flared]	In. [mm]	3/8 [6.35]
	Liquid Pipe Size O.D. [Flared]	In. [mm]	1/4 [6.35]

NOTES:
Conditions

¹Cooling (Indoor // Outdoor) °F 80 DB, 67 WB // 95 DB, 75 WB
²Heating at 47°F (Indoor // Outdoor) °F 70 DB, 60 WB // 47 DB, 43 WB

³Capacity varies based on the number of indoor units operating and the model of the Multi-zone Outdoor Unit. For reference to connected capacity charts, please refer Multi-zone Outdoor Unit Operational Performance.:

INDOOR UNIT ACCESSORIES: MSZ-FS09NA

Control Interface	BACnet® and Modbus Interface	PAC-UKPRC001-CN-1
	CN24 Relay Kit	CN24RELAY-KIT-CM3
	IT Extender	PAC-WHS01IE-E
	kumo station® for kumo cloud®	PAC-WHS01HC-E
	Lockdown bracket for remote controller	RCMKP1CB
	System Control Interface	MAC-334IF-E
	Thermostat Interface	PAC-US444CN-1
	USNAP Adapter	PAC-WHS01UP-E
Remote Sensor	Wireless Interface for kumo cloud®	PAC-USWHS002-WF-2
	Wired Remote Sensor	M21EAA307
Wired Remote Controller	Wireless temperature and humidity sensor for kumo cloud®	PAC-USWHS003-TH-1
	Deluxe Wired MA Remote Controller†	PAR-40MAAU
	Simple MA Remote Controller†	PAC-YT53CRAU-J
Wireless Remote Controller	Touch MA Controller†	PAR-CT01MAU-SB
	kumo touch™ RedLINK™ Wireless Controller	MHK2
Condensate	Blue Diamond (MicroBlue) Mini Condensate Pump (110/208/230V) up to 18,000 BTU/H	X85-003
	Blue Diamond Alarm Extension Cable — 6.5 Ft.	C13-192
	Blue Diamond MultiTank — collection tank for use with multiple pumps	C21-014
	Blue Diamond Sensor Extension Cable — 15 Ft.	C13-103
	Drain Pan Level Sensor/Control	SS610E
	Fascia Kit for MicroBlue Pump, mounts the MicroBlue and sensor directly beneath indoor unit	T18-016
	Sauermann Condensate Pump	SI30-230
Disconnect Switch	(30A/600V/UL) [fits 2" X 4" utility box] - Black	TAZ-MS303
	(30A/600V/UL) [fits 2" X 4" utility box] - White	TAZ-MS303W
Filter	Electro Static Anti-allergy Enzyme Filter	MAC-2330FT-E
	Platinum Deodorizing Filter	MAC-3000FT-E
Lineset	15' x 1/4" x 15' / 3/8" Lineset (Twin-Tube Insulation)	MLS143812T-15
	30' x 1/4" x 30' / 3/8" Lineset (Twin-Tube Insulation)	MLS143812T-30
	50' x 1/4" x 50' / 3/8" Lineset (Twin-Tube Insulation)	MLS143812T-50
	65' x 1/4" x 65' / 3/8" Lineset (Twin-Tube Insulation)	MLS143812T-65

NOTES:

†Requires MAC-334IF-E

- EZ FIT® Recessed Ceiling Cassette, Floor-mount and Wall-mount
Allows indoor units to connect to an MA Controller:
 - Deluxe MA Remote Controller
 - Simple MA Controller
 - Touch MA Controller

*PAC-SF40RM-E (Unable to use with wireless remote controller)

- Ceiling Cassette, Ceiling Suspended, Horizontal-ducted and Multi-position Air Handler
- P-Series Ceiling Cassette, Ceiling Suspended, Horizontal-ducted and Multi-position Air Handler

INDOOR UNIT DIMENSIONS: MSZ-FS09NA

Unit: inch

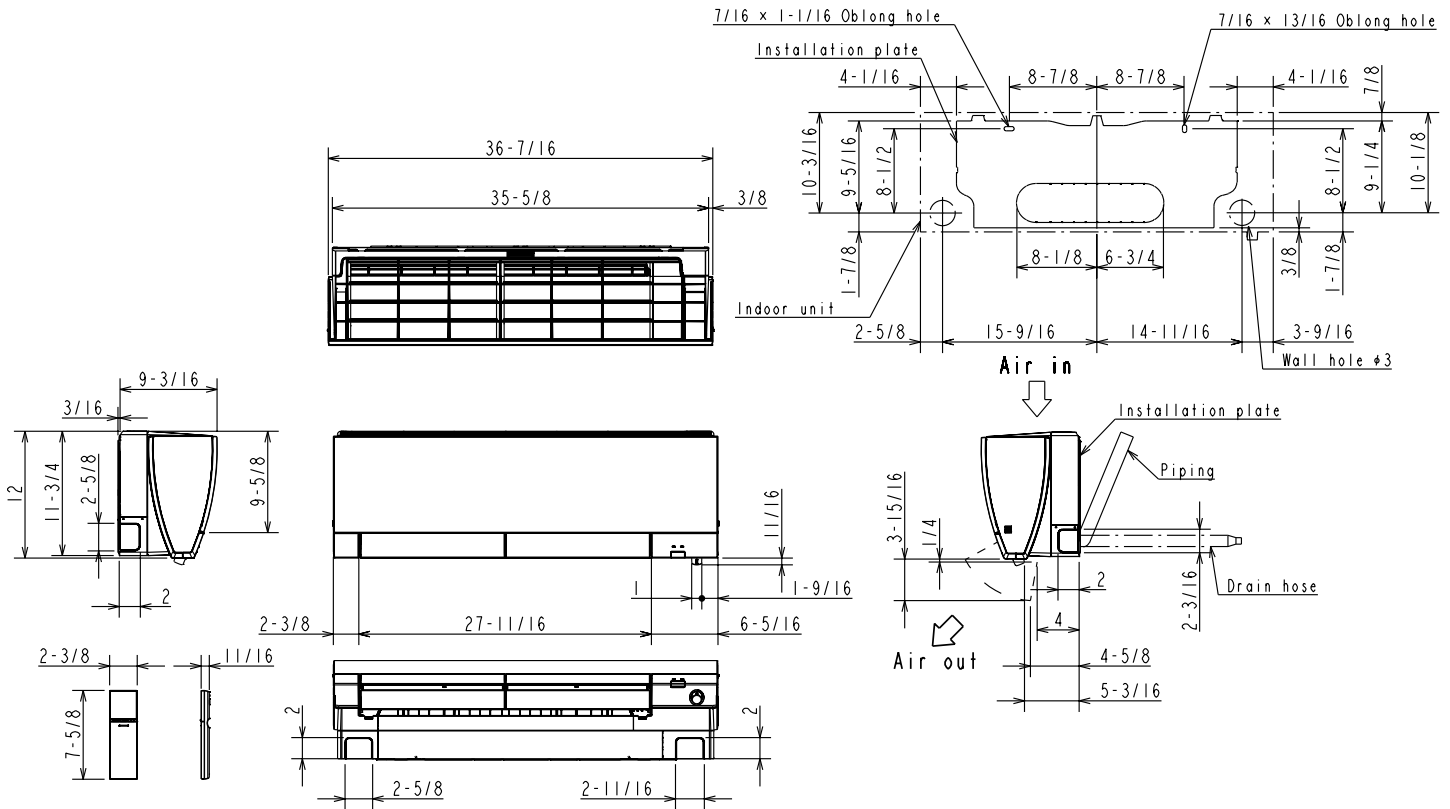

(06/09/12 KBTU/H)

Piping	Insulation	Ø1-7/16 O.D
	Liquid line	Ø1/4 19-11/16 (Flared connection Ø1/4)
	Gas line	Ø3/8 16-15/16 (Flared connection Ø3/8)
Drain hose	Insulation	Ø1-1/8 Connected part Ø5/8 O.D

(15/18 KBTU/H)

Piping	Insulation	Ø1-7/16 O.D
	Liquid line	Ø1/4 19-11/16 (Flared connection Ø1/4)
	Gas line	Ø3/8 16-15/16 (Flared connection Ø1/2)
Drain hose	Insulation	Ø1-1/8 Connected part Ø5/8 O.D

1340 Satellite Boulevard Suwanee, GA 30024
Toll Free: 800-433-4822 www.mehvac.com

FORM# MSZ-FS09NA-U1 - 202101



MSZ-FS18NA 18,000 BTU/H DELUXE WALL MOUNT



Job Name:

System Reference:

Date:



GENERAL FEATURES

- Slim wall-mounted indoor units provide zone comfort control
- Dual Barrier Coating applied to the heat exchanger, vanes and fan to prevent hydrophilic and hydrophobic dirt build-up
- Multiple fan speed options: Quiet, Low, Medium, High, Super-high, Auto
- 3D i-see Sensor® enables advance features:
 - Indirect or Direct Airflow for personalized comfort
 - Absence Detection for energy-saving mode
 - Double Vane features:
 - Separates airflow to deliver air across a large area
 - Simultaneously deliver to air separate sections of a room
 - Generates more comfortable natural airflow pattern
- Multiple control options available:
 - Back-lit screen handheld remote controller (provided with unit)
 - kumo cloud® smart device app for remote access
 - Third-party interface options
 - Wired or wireless controllers
- Triple-action Filtration: Nano Platinum Filter, Deodorizing Filter, & Electrostatic Anti-Allergy Enzyme Filter
- Hot-Start Technology: no cold air rush at equipment startup or when restarting after Defrost Cycle
- Quiet operation

Specifications		System	
Unit Type		MSZ-FS18NA	
Cooling Capacity ^{1,3}		BTU/H	17,200
Heating Capacity ^{2,3}		BTU/H	19,000
Electrical	Voltage, Phase, Frequency		208/230, 1, 60
	Guaranteed Voltage Range	V AC	187- 253V
	Voltage: Indoor - Outdoor, S1-S2	V AC	208/230
	Voltage: Indoor - Outdoor, S2-S3	V DC	24
	Short-circuit Current Rating [SCCR]	kA	5
Indoor Unit	MCA	A	1.0
	Fan Motor Full Load Amperage	A	0.65
	Fan Motor Output	W	40
	Airflow Rate at Cooling, Dry	CFM	225-272-304-355-437
	Airflow Rate at Cooling, Wet	CFM	194-225-261-305-376
	Airflow Rate at Heating, Dry	CFM	201-272-350-410-514
	Sound Pressure Level [Cooling]	dB[A]	27-31-35-39-44
	Sound Pressure Level [Heating]	dB[A]	25-31-37-40-46
	Drain Pipe Size	In. [mm]	5/8 [15.88]
	Coating on Heat Exchanger		Dual Barrier Coating
	External Finish Color		Munsell 1.0Y 9.2/0.2
	Unit Dimensions	W x D x H: In. [mm]	36-7/16 x 9-3/16 x 12 (+11/16) [925 x 234 x 305 (+17)]
	Package Dimensions	W x D x H: In. [mm]	39 x 12-1/4 x 15-1/2 [990 x 310 x 400]
Unit Weight	Lbs. [kg]	29 [13.5]	
Package Weight	Lbs. [kg]	39 x 12-1/4 x 15-1/2 [990 x 310 x 400]	
Refrigerant	Type		R410A
Piping	Gas Pipe Size O.D. [Flared]	In. [mm]	1/2 [12.7]
	Liquid Pipe Size O.D. [Flared]	In. [mm]	1/4 [6.35]

NOTES:
Conditions

¹Cooling (Indoor // Outdoor) °F 80 DB, 67 WB // 95 DB, 75 WB
²Heating at 47°F (Indoor // Outdoor) °F 70 DB, 60 WB // 47 DB, 43 WB

³Capacity varies based on the number of indoor units operating and the model of the Multi-zone Outdoor Unit. For reference to connected capacity charts, please refer Multi-zone Outdoor Unit Operational Performance.:

INDOOR UNIT ACCESSORIES: MSZ-FS18NA

Control Interface	BACnet® and Modbus Interface	PAC-UKPRC001-CN-1
	CN24 Relay Kit	CN24RELAY-KIT-CM3
	IT Extender	PAC-WHS01IE-E
	kumo station® for kumo cloud®	PAC-WHS01HC-E
	Lockdown bracket for remote controller	RCMKP1CB
	System Control Interface	MAC-334IF-E
	Thermostat Interface	PAC-US444CN-1
	USNAP Adapter	PAC-WHS01UP-E
Remote Sensor	Wireless Interface for kumo cloud®	PAC-USWHS002-WF-2
	Wired Remote Sensor	M21EAA307
Wired Remote Controller	Wireless temperature and humidity sensor for kumo cloud®	PAC-USWHS003-TH-1
	Deluxe Wired MA Remote Controller†	PAR-40MAAU
	Simple MA Remote Controller†	PAC-YT53CRAU-J
Wireless Remote Controller	Touch MA Controller†	PAR-CT01MAU-SB
	kumo touch™ RedLINK™ Wireless Controller	MHK2
Condensate	Blue Diamond (MicroBlue) Mini Condensate Pump (110/208/230V) up to 18,000 BTU/H	X85-003
	Blue Diamond Alarm Extension Cable — 6.5 Ft.	C13-192
	Blue Diamond MultiTank — collection tank for use with multiple pumps	C21-014
	Blue Diamond Sensor Extension Cable — 15 Ft.	C13-103
	Drain Pan Level Sensor/Control	SS610E
	Fascia Kit for MicroBlue Pump, mounts the MicroBlue and sensor directly beneath indoor unit	T18-016
	Sauermann Condensate Pump	SI30-230
Disconnect Switch	(30A/600V/UL) [fits 2" X 4" utility box] - Black	TAZ-MS303
	(30A/600V/UL) [fits 2" X 4" utility box] - White	TAZ-MS303W
Filter	Electro Static Anti-allergy Enzyme Filter	MAC-2330FT-E
	Platinum Deodorizing Filter	MAC-3000FT-E
Lineset	15' x 1/4" x 15' / 1/2" Lineset (Twin-Tube Insulation)	MLS141212T-15
	30' x 1/4" x 30' / 1/2" Lineset (Twin-Tube Insulation)	MLS141212T-30
	50' x 1/4" x 50' / 1/2" Lineset (Twin-Tube Insulation)	MLS141212T-50
	65' x 1/4" x 65' / 1/2" Lineset (Twin-Tube Insulation)	MLS141212T-65

NOTES:

†Requires MAC-334IF-E

- EZ FIT® Recessed Ceiling Cassette, Floor-mount and Wall-mount
Allows indoor units to connect to an MA Controller:
 - Deluxe MA Remote Controller
 - Simple MA Controller
 - Touch MA Controller

‡PAC-SF40RM-E (Unable to use with wireless remote controller)

- Ceiling Cassette, Ceiling Suspended, Horizontal-ducted and Multi-position Air Handler
- P-Series Ceiling Cassette, Ceiling Suspended, Horizontal-ducted and Multi-position Air Handler

INDOOR UNIT DIMENSIONS: MSZ-FS18NA

Unit: inch



(06/09/12 KBTU/H)

Piping	Insulation	ø1-7/16 O.D
	Liquid line	ø1/4 19-11/16 (Flared connection ø1/4)
	Gas line	ø3/8 16-15/16 (Flared connection ø3/8)
Drain hose	Insulation	ø1-1/8 Connected part ø5/8 O.D

(15/18 KBTU/H)

Piping	Insulation	ø1-7/16 O.D
	Liquid line	ø1/4 19-11/16 (Flared connection ø1/4)
	Gas line	ø3/8 16-15/16 (Flared connection ø1/2)
Drain hose	Insulation	ø1-1/8 Connected part ø5/8 O.D

1340 Satellite Boulevard Suwanee, GA 30024
Toll Free: 800-433-4822 www.mehvac.com



MODEL: PAC-MKA30BC, PAC-MKA31BC, PAC-MKA32BC PAC-MKA50BC, PAC-MKA51BC, AND PAC-MKA52BC BRANCH BOX



Job Name:

System Reference:

Date:



PAC-MKA30BC
PAC-MKA31BC
PAC-MKA32BC



PAC-MKA50BC
PAC-MKA51BC
PAC-MKA52BC

DESCRIPTIONS

- The PAC-MKA32/52 have a thermal differential from set point of 1F regardless of which MXZ outdoor unit generation they are connected to.

SPECIFICATIONS

Model Name			PAC-MKA50BC PAC-MKA51BC PAC-MKA52BC		PAC-MKA30BC PAC-MKA31BC PAC-MKA32BC		
Connectable number of indoor units			Maximum 5		Maximum 3		
Power supply			Single phase, 208/230 V, 60 Hz				
Input		kW	0.003				
Running current		A	0.05				
External finish			Galvanized steel				
Dimensions	Width	Inch (mm)	17-23/32 (450)				
	Depth	Inch (mm)	11-1/32 (280)				
	Height	Inch (mm)	6-11/16 (170)				
Package Dimensions	Width	Inch (mm)	20.1 (511)				
	Depth	Inch (mm)	24.4 (620)				
	Height	Inch (mm)	8.3 (211)				
Weight		lb (kg)	23.4 (10.6)		21.8 (9.9)		
Piping Connection (Flare)	Branch (indoor side)*	Liquid	Inch (mm)	ø1/4 (6.35) x 5 {A,B,C,D,E}		ø1/4 (6.35 x 3 {A,B,C}	
		Gas	Inch (mm)	ø3/8 (9.52) x 4 {A,B,C,D}, ø1/2 (12.7) x 1{E}		ø3/8 (9.52) x 3 {A,B,C}	
	Main (outdoor side)	Liquid	Inch (mm)	ø3/8 (9.52)			
		Gas	Inch (mm)	ø5/8 (15.88)			

*The piping connection size differs according to the type of and capacity of indoor units. Match the piping connection size for indoor and branch box. If the piping connection size of the branch does not match the piping connection size of the indoor units, use optional different-diameter (deformed) joints to the branch box side. (Connect deformed joint directly to the branch box side.)

ACCESSORIES

BBE-1	Branch Box Enclosure
MAC-A454JP-E	Port Adapter
MAC-A455JP-E	Port Adapter
MAC-A456JP-E	Port Adapter
PAC-493PI	Port Adapter
PAC-SG76RJ-E	Port Adapter
ADP5834	Port Adapter
MSDD-50AR-D	Flare connection distribution pipe
MSDD-50BR-E	Brazed connection distribution pipe

NOTES:

For the MXZ-8C60 outdoor unit:

- When connecting the outdoor unit to the branch box directly, the reduction in pipe size must be made at the branch box using the port adaptor: ADP5834 (5/8" F x 3/4" M).
- When connecting the outdoor unit to the distribution pipe (MSDD-50AR-D, for using 2 branch boxes), the reduction in pipe size must be made at the distribution pipe using the port adaptor: ADP5834 (5/8" F x 3/4" M).

OPTIONAL PORT ADAPTORS

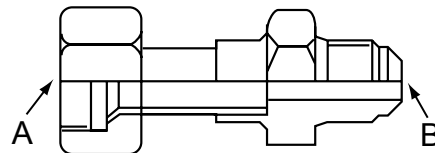

Model name	Connected pipes diameter	Diameter A	Diameter B
	Inch, mm	Inch, mm	Inch, mm
MAC-A454JP-E	3/8, ø9.52 → 1/2, ø12.7	3/8, ø9.52	1/2, ø12.7
MAC-A455JP-E	1/2, ø12.7 → 3/8, ø9.52	1/2, ø12.7	3/8, ø9.52
MAC-A456JP-E	1/2, ø12.7 → 5/8, ø15.88	1/2, ø12.7	5/8, ø15.88
PAC-493PI	1/4, ø6.35 → 3/8, ø9.52	1/4, ø6.35	3/8, ø9.52
PAC-SG76RJ-E	3/8, ø9.52 → 5/8, ø15.88	3/8, ø9.52	5/8, ø15.88
ADP5834	5/8, ø15.88 → 3/4, ø19.05	5/8, ø15.88	3/4, ø19.05

DIMENSIONS: PAC-MKA30BC, PAC-MKA31BC, AND PAC-MKA32BC

PAC-MKA30BC, PAC-MKA31BC, AND PAC-MKA32BC (3-BRANCHES TYPE)

Suspension bolt: W3/8 (M10)
 Refrigerant pipe flared connection

inch, mm

	To indoor unit			To outdoor unit
	A	B	C	
Liquid pipe	1/4, ø6.35	1/4, ø6.35	1/4, ø6.35	3/8, ø9.52
Gas pipe	3/8, ø9.52	3/8, ø9.52	3/8, ø9.52	5/8, ø15.88

Conversion formula	
3/8F	ø9.52
5/8F	ø15.88

Unit: mm (inch)

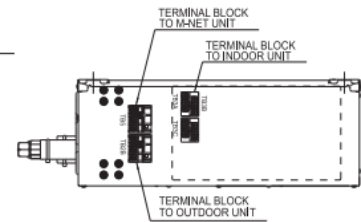
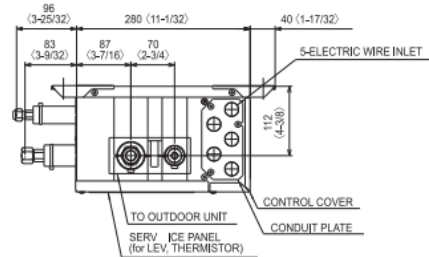
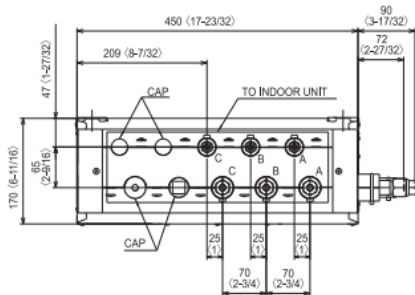
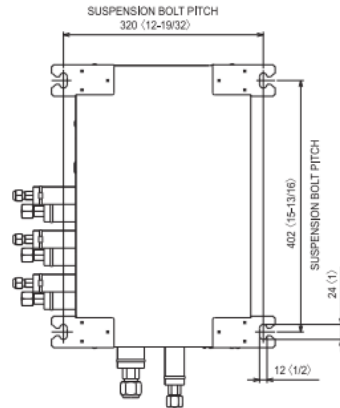

DIMENSIONS: PAC-MKA50BC, PAC-MKA51BC, AND PAC-MKA52BC

PAC-MKA50BC, PAC-MKA51BC, AND PAC-MKA52BC (5-BRANCHES TYPE)

Suspension bolt: W3/8 (M10)
Refrigerant pipe flared connection

inch, mm

	To indoor unit					To outdoor unit
	A	B	C	D	E	
Liquid pipe	1/4, ø6.35	1/4, ø6.35	1/4, ø6.35	1/4, ø6.35	1/4, ø6.35	3/8, ø9.52
Gas pipe	3/8, ø9.52	3/8, ø9.52	3/8, ø9.52	3/8, ø9.52	1/2, ø12.7	5/8, ø15.88

Conversion formula	
1/4F	ø6.35
3/8F	ø9.52
1/2F	ø12.7
5/8F	ø15.88
3/4F	ø19.05

Unit: mm (inch)

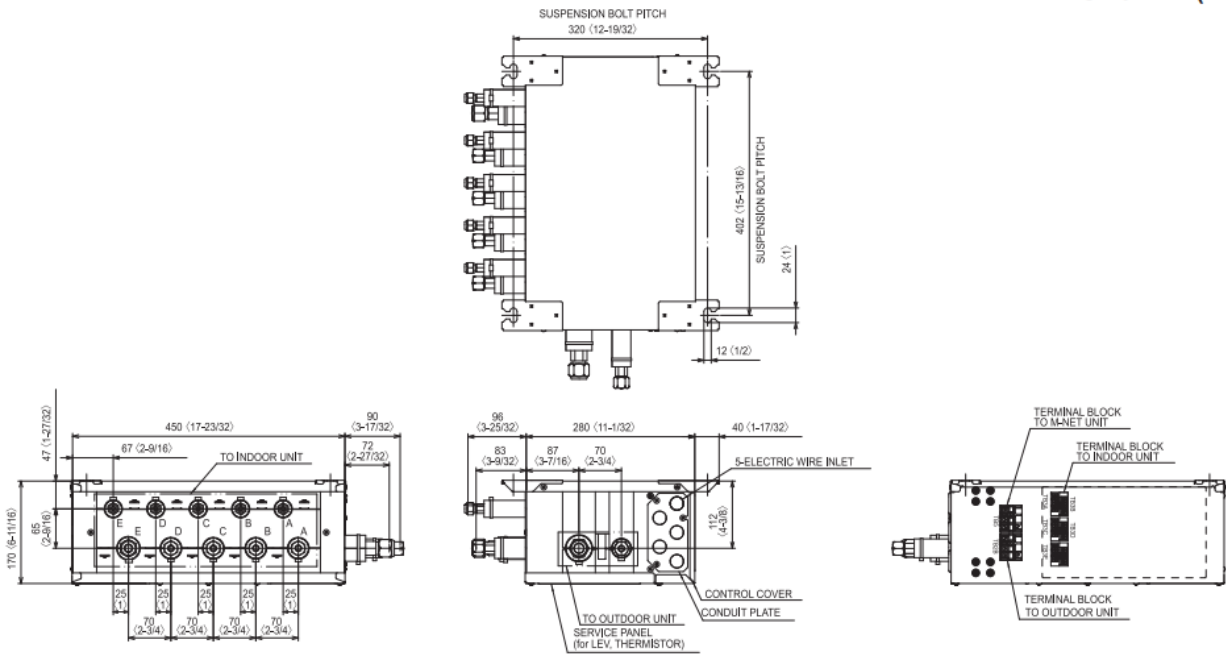

1340 Satellite Boulevard, Suwanee, GA 30024
Toll Free: 800-433-4822 www.mehvac.com

MXZ-SM48NAMHZ-U1 4-TON MULTI-ZONE INVERTER HEAT-PUMP SYSTEM



Job Name:

System Reference:

Date:



FEATURES

- Compatible with M- and P-Series and CITY MULTI indoor units. Branch box required for connection with M- and P-Series
- Variable speed INVERTER-driven compressor
- Seacoast protection on heat exchanger and base panel (rated for 2,000 hrs in accordance with ASTM B117 testing)
- Thermal Differential 1°F (with PAC-MKA32/52BC only)
- Built-in base pan heater
- Quiet outdoor unit operation, rated sound pressure as low as 51 dB(A)
- High pressure protection
- Compressor thermal protection
- Compressor overcurrent detection
- Fan motor overheating/voltage protection
- Hyper-heating performance offers 100% heating capacity at 5°F and 75% heating capacity at -13°F

ENERGY STAR products are third-party certified by an EPA-recognized Certification Body.

Specifications are subject to change without notice.

© 2022 Mitsubishi Electric Trane HVAC US LLC. All rights reserved.

SPECIFICATIONS: MXZ-SM48NAMHZ-U1

Cooling ¹ (Non-Ducted // Mix // Ducted)	Maximum Capacity	BTU/H	48,000 // 48,000 // 48,000	
	Rated Capacity	BTU/H	48,000 // 48,000 // 48,000	
	Minimum Capacity	BTU/H	16,000 // 16,000 // 16,000	
	Maximum Power Input	W	3,665 // 3,930 // 4,245	
	Rated Power Input	W	3,665 // 3,930 // 4,245	
	Power Factor (208V, 230V)	%	98.5, 98.5 // 98.5, 98.5 // 98.5, 98.5	
Heating at 47°F ² (Non-Ducted // Mix // Ducted)	Maximum Capacity	BTU/H	54,000 // 54,000 // 54,000	
	Rated Capacity	BTU/H	54,000 // 54,000 // 54,000	
	Minimum Capacity	BTU/H	27,000 // 27,000 // 27,000	
	Maximum Power Input	W	3,955 // 4,335 // 4,795	
	Rated Power Input	W	3,955 // 4,335 // 4,795	
	Power Factor (208V, 230V)	%	98.5, 98.5 // 98.5, 98.5 // 98.5, 98.5	
Heating at 17°F ³ (Non-Ducted // Mix // Ducted)	Maximum Capacity	BTU/H	54,000 // 54,000 // 54,000	
	Rated Capacity	BTU/H	39,000 // 39,000 // 39,000	
	Maximum Power Input	W	6,330 // 7,750 // 3,665	
	Rated Power Input	W	4,230 // 4,680 // 5,130	
Heating at 5°F ⁴ (Non-Ducted // Mix // Ducted)	Maximum Capacity	BTU/H	54,000 // 54,000 // 54,000	
	Maximum Power Input	W	7,915 // 8,120 // 8,330	
Efficiency (Non-Ducted // Mix // Ducted)	SEER		23.0 // 19.75 // 16.5	
	EER ¹		13.1 // 12.2 // 11.3	
	HSPF (IV)		12.0 // 11.5 // 11.0	
	COP at 47°F ²		4.0 // 3.65 // 3.3	
	COP at 17°F at Maximum Capacity ³		2.5 // 2.0 // 1.8	
	COP at 5°F at Maximum Capacity ⁴		2.1 // 1.95 // 1.9	
	ENERGY STAR [®] Certified		Yes // No // No	
Electrical	Voltage, Phase, Frequency		208/230, 1, 60	
	Guaranteed Voltage Range	V AC	187-253	
	Voltage: Indoor - Outdoor, S1-S2	V AC	208/230	
	Voltage: Indoor - Outdoor, S2-S3	V DC	24	
	Short-circuit Current Rating (SCCR)	kA	5	
	Recommended Fuse/Breaker Size if Branch Box Powered by Outdoor Unit	A	45	
	Recommended Fuse/Breaker Size without Branch Box or Branch Box Powered Separate	A	40	
	Recommended Wire Size (Indoor - Outdoor)	AWG	16	
	MCA if Branch Box Powered by Outdoor Unit	A	42.0	
	MCA without Branch Box or Branch Box Powered Separate	A	36	
	MOCP if Branch Box Powered by Outdoor Unit	A	50	
	MOCP without Branch Box or Branch Box Powered Separate	A	40	
	Fan Motor Full Load Amperage	A	0.6+0.6	
	Fan Motor Output	W	74	
Outdoor unit	Airflow Rate (Cooling / Heating)	CFM	3,885 / 3,885	
	Refrigerant Control		LEV	
	Defrost Method		Reverse Cycle	
	Heat Exchanger Type		Plate fin coil	
	Heat Exchanger Coating		Blue Fin Coating	
	Sound Pressure Level, Cooling ¹	dB(A)	51	
	Sound Pressure Level, Heating ²	dB(A)	54	
	Compressor Type		Hermetic	
	Compressor Model		ANB33FJSMT	
	Compressor Motor Output	kW	3.4	
	Compressor Rated Load Amps	A	19	
	Compressor Locked Rotor Amps	A	22.0	
	Compressor Oil Type // Charge	oz.	FV50S // 73	
	Base Pan Heater		Built-in	
	Unit Dimensions	W: In. [mm]		41-11/32[1,050]
		D: In. [mm]		13[330]
		H: In. [mm]		52-11/16[1,338]
	Package Dimensions	W: In. [mm]		43 [1,090]
		D: In. [mm]		18 [450]
		H: In. [mm]		57 [1,430]
Unit Weight	Lbs.[kg]		278 [126]	
Package Weight	Lbs.[kg]		302 [137]	

NOTES:

AHRI Rated Conditions (Rated data is determined at a fixed compressor speed)	¹ Cooling (Indoor // Outdoor)	°F	80 DB, 67 WB // 95 DB, 75 WB
	² Heating at 47°F (Indoor // Outdoor)	°F	70 DB, 60 WB // 47 DB, 43 WB
	³ Heating at 17°F (Indoor // Outdoor)	°F	70 DB, 60 WB // 17 DB, 15 WB
Conditions	⁴ Heating at 5°F (Indoor // Outdoor)	°F	70 DB, 60 WB // 5 DB, 4 WB

*Applications should be restricted to comfort cooling only; equipment cooling applications are not recommended for low ambient temperature conditions.

^A when 1 or more PLA-A-EA7 connected

^B Branch box should be placed within the level between the outdoor unit and indoor units

^C 5°F DB - 115°F DB when optional wind baffles are installed

For actual capacity performance based on indoor unit type and number of indoor units connected, please refer to MXZ Operational Performance.

Although the maximum connectable capacity is 130%, the outdoor unit cannot provide more than 100% of the rated capacity. Please utilize this over capacity capability for load shedding or applications where it is known that all connected units will NOT be operating at the same time.

SPECIFICATIONS: MXZ-SM48NAMHZ-U1

Outdoor unit operating temperature range	Cooling Intake Air Temp (Maximum / Minimum)	°FDB	115 / 23
	Cooling Thermal Lock-out / Re-start Temperatures	°FDB	N/A / N/A
	Heating Intake Air Temp (Maximum / Minimum)	°FWB	59 / -13
	Heating Thermal Lock-out / Re-start Temperatures	°FDB	-24 / -14
Refrigerant	Type		R410A
	Charge	Lbs, oz	10, 9.0
Indoor unit connection	Maximum Number of Connected IDU with Branch Box		8 (6) ^A
	Maximum Number of Connected IDU without Branch Box		12
	Minimum Number of Connected IDU with Branch Box		2
	Minimum Number of Connected IDU without Branch Box		1
	Minimum Connected Capacity with Branch Box	BTU/H	12,000
	Maximum Connected Capacity	BTU/H	62,000
Piping	Liquid Pipe Size O.D. (Flared)	In.[mm]	3/8 [9.52]
	Gas Pipe Size O.D. (Flared)	In.[mm]	5/8 [15.88]
	Total Piping Length when using Branch Box	Ft. [m]	492 [150]
	Total Piping Length without Branch Box	Ft. [m]	984 [300]
	Maximum Height Difference ^B , ODU above IDU	Ft. [m]	164 [50]
	Maximum Height Difference ^B , ODU below IDU	Ft. [m]	131 [40]
	Maximum Height Difference ^B , between branch boxes	Ft. [m]	49 [15]
	Maximum Height Difference ^B , between branch boxes and IDU	Ft. [m]	49 [15]
	Maximum Height Difference between IDU and IDU without branch box	Ft. [m]	49 [15]
	Max. Piping Length between ODU and Branch Box	Ft. [m]	180 [55]
	Farthest Piping Length from ODU to IDU with Branch Box	Ft. [m]	262 [80]
	Farthest Piping Length from ODU to IDU without Branch Box	Ft. [m]	492 [150]
	Farthest Piping Length after Branch Box	Ft. [m]	82 [25]
	Total Piping Length between Branch Boxes and IDU	Ft. [m]	311 [95]
Maximum Number of Bends for IDU		15	

NOTES:

AHRI Rated Conditions (Rated data is determined at a fixed compressor speed)

¹ Cooling (Indoor // Outdoor)	°F	80 DB, 67 WB // 95 DB, 75 WB
² Heating at 47°F (Indoor // Outdoor)	°F	70 DB, 60 WB // 47 DB, 43 WB
³ Heating at 17°F (Indoor // Outdoor)	°F	70 DB, 60 WB // 17 DB, 15 WB

Conditions ⁴Heating at 5°F (Indoor // Outdoor) °F 70 DB, 60 WB // 5 DB, 4 WB

^AApplications should be restricted to comfort cooling only; equipment cooling applications are not recommended for low ambient temperature conditions.

^A when 1 or more PLA-A-EA7 connected

^B Branch box should be placed within the level between the outdoor unit and indoor units

^C 5°F DB - 115°F DB when optional wind baffles are installed

For actual capacity performance based on indoor unit type and number of indoor units connected, please refer to MXZ Operational Performance.

Although the maximum connectable capacity is 130%, the outdoor unit cannot provide more than 100% of the rated capacity. Please utilize this over capacity capability for load shedding or applications where it is known that all connected units will NOT be operating at the same time.

OUTDOOR UNIT ACCESSORIES: MXZ-SM48NAMHZ-U1

Air Deflector	Vertical Air Deflector	ADV-1
Air Outlet Guide	Air Outlet Guide (1 Piece)	PAC-SH96SG-E (two pieces are required)
Ball Valve	Refrigeration Ball Valve - 1/2"	BV12FFSI2
	Refrigeration Ball Valve - 1/4"	BV14FFSI2
	Refrigeration Ball Valve - 3/8"	BV38FFSI2
	Refrigeration Ball Valve - 5/8"	BV58FFSI2
Branch Box	Branch Box	PAC-MKA32BC
	Branch Box	PAC-MKA52BC
	Branch Box Enclosure	BBE-1
Centralized Drain Pan	Central Drain Pan	PAC-SH97DP-E
Control Wire	M-Net Control Wire, 1,000' Roll (16-AWG, Standard, Twisted Pair, Shielded, Jacketed- Plenum rated)	CW162S-1000
	M-Net Control Wire, 250' Roll (16-AWG, Standard, Twisted Pair, Shielded, Jacketed- Plenum rated)	CW162S-250
Control/Service Tool	Maintenance Tool Interface	PAC-USCMS-MN-1
Distribution pipe	Brazed Connection	MSDD-50BR-E
	Flare Connection	MSDD-50AR-E
Hail Guards	Hail Guard	HG-A2
Mini-Split Wire	14 Gauge, 4 wire MiniSplit Cable—250 ft. roll	S144-250
	14 Gauge, 4 wire MiniSplit Cable—50 ft. roll	S144-50
	16 Gauge, 4 wire MiniSplit Cable—250 ft. roll	S164-250
	16 Gauge, 4 wire MiniSplit Cable—50 ft. roll	S164-50
Mounting Pad	Condensing Unit Mounting Pad: 24" x 42" x 3"	ULTRILITE2
	Outdoor Unit 3-1/4 inch Mounting Base (Pair) - Plastic	DSD-400P
Port Adapter	Adaptor: 1/2" x 3/8"	MAC-A455JP-E
	Adaptor: 1/2" x 5/8"	MAC-A456JP-E
	Adaptor: 3/8" x 1/2"	MAC-A454JP-E
	Adaptor: 3/8" x 5/8"	PAC-SG76RJ-E
Stand	18" Dual Fan Stand	QSMS1802M
	24" Dual Fan Stand	QSMS2402M
	Condenser Wall Bracket	QSWB2000M-1
	Condenser Wall Bracket - Stainless Steel Finish	QSWBSS
	Outdoor Unit Stand — 12" High	QSMS1202M
Wind Baffle	Front Wind Baffle	WB-PA3 (two pieces are required)

OUTDOOR UNIT DIMENSIONS: MXZ-SM48NAMHZ-U1

Unit: mm
<inch>

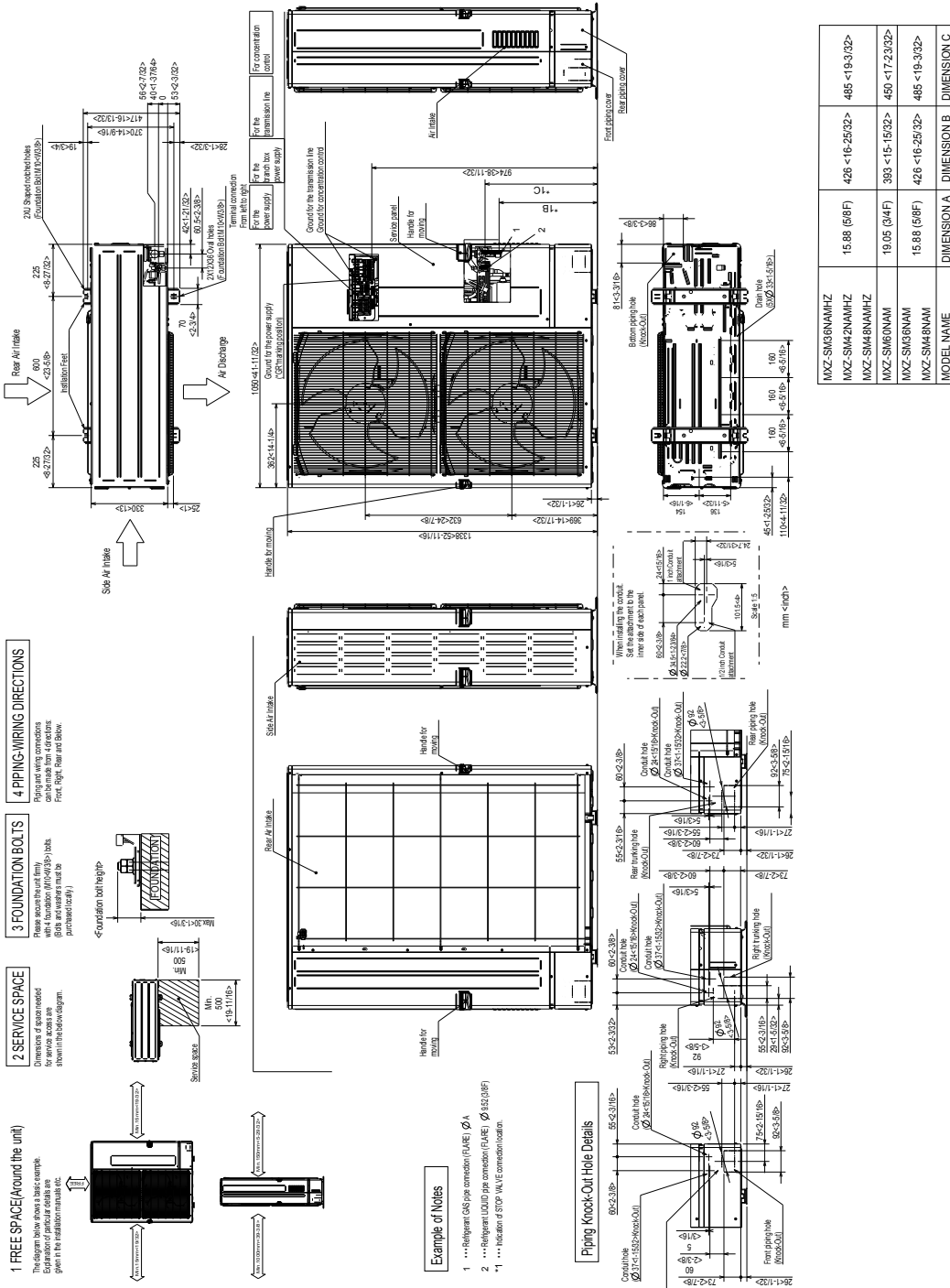

MODEL NAME	DIMENSION A	DIMENSION B	DIMENSION C
MXZ-SM6NAMHZ	15.88 (6.8F)	426 <16-2532>	486 <19-332>
MXZ-SM42NAMHZ	15.88 (6.8F)	426 <16-2532>	486 <19-332>
MXZ-SM48NAMHZ	19.05 (9.4F)	383 <15-1532>	459 <17-2332>
MXZ-SM6NAM	15.88 (6.8F)	426 <16-2532>	486 <19-332>
MXZ-SM48NAM	15.88 (6.8F)	426 <16-2532>	486 <19-332>