

Ronco®

EZ-Store™

Rotisserie Oven

INSTRUCTIONS & RECIPES



Best Rotisserie

"Dollar for dollar, the finest kitchen appliance ever made."

- Malcolm Gladwell,
What the Dog Saw

Set It and Forget It!®

Time is precious. Just set the timer and we'll do the rest, leaving you more time for family.

Cook Like a Gourmet™

Makes perfectly roasted chickens, turkey, pork or rib roasts, and burgers that are delicious and healthy too!



EZ-Store™ Rotisserie

Table of Contents

Important Safeguards / Cleaning & Care	3-5
Rotisserie Model Specs.....	6
Parts Included.....	6
Getting Started: Setting Up Your Rotisserie	7
Non-stick Spit Rod Assembly	8
Rotisserie Basket.....	9
How to Tie Chicken & How to Tie Turkey.....	10-11
Placing Poultry on the Spit Assembly.....	12
A or B Cooking Position.....	13
Loading the Spit Assembly	14
Digital Timer	15
Carving Platform.....	16
Time & Temperature Chart	17
Available Accessories (sold separately)	18-22
Cautions & Helpful Hints	23-24
Meal Suggestions & Recipes.....	25-29
6 Easy Steps to Rotisserie Chicken	30-31
Warranty.....	32

Seals in natural juices and drains off unwanted fat as it cooks. About ¼ cup of animal fat drips off a 4 lb. chicken.

Evenly browns chicken, roasts, seafood, vegetables, chops, steaks, hamburgers, sausages, hams, pork loin roasts, and even ribs!

Timer makes it easy to use and automatically shuts off when the time is up.

Dishwasher safe. Drip Tray, Entire Spit Rod Assembly, Glass Door, and Kabob Rods are all dishwasher safe.

The Rotisserie Basket allows you to enjoy greater variety of Rotisserie foods and wraps (placing foods in foil, then in Basket).

Lighted Oven makes it easy and fun to watch your food cook.

Energy Efficient. Cooks faster than a conventional oven but still uses about half the electricity!

IMPORTANT SAFEGUARDS

The EZ-Store Rotisserie WILL NOT turn on without the back legs extended and the rotisserie in the up-right position. Heat Shield, and Drip Tray must also be in place. When using electrical appliances, basic safety precautions should always be taken, including the following:

1. VERY IMPORTANT: Read all instructions before using the machine.
2. To protect against electrical hazards, do not immerse cord, plug or appliance itself in water or other liquids.
3. Do not touch hot surfaces. NOTE: (Glass Door, top, back and sides of the Rotisserie, as well as the Drip Tray, Heat Shield and Heating Element all get very hot during use and retain heat after use.) Always use adequate oven mitts or gloves when handling these hot surfaces and when checking hot foods.
4. FOR ADULT USE ONLY: Close supervision is always necessary when the Rotisserie is used near children.
5. Unplug Rotisserie from outlet when not in use, and allow unit to cool thoroughly before putting on or taking off parts, such as the Drip Tray before cleaning.
6. Do not operate any appliance with a damaged cord or plug or after the appliance malfunctions or is dropped or damaged in any manner. Return the appliance to Ronco Holdings, Inc. for examination, repair, electrical or mechanical adjustment. Call 1-855-85-RONCO (76626) for return instructions.
7. Turn off and unplug the Rotisserie if you smell or see heavy smoke or fire. After it has cooled down, make adjustments so nothing touches the Heating Element as the food rotates. Do not open the Glass Door until it has cooled down. This is an electrical appliance; never put water in it, or on it to cool it down or stop it from smoking.
8. The use of accessory attachments not recommended by Ronco Holdings, Inc. may cause injuries.
9. Do not use outdoors.
10. Do not let cord hang over edge of table or counter or touch hot surfaces.
11. Do not place appliance on or near a hot gas or electric burner, in a heated oven or near easily flammable material.
12. Use only on a stable, heat-resistant surface and place unit at least 8" (inches) from walls and 8" clear above unit.
13. To disconnect, turn rotisserie OFF, then grip plug and pull from wall outlet. Do not pull on cord.
14. Always unplug the unit before attempting to move it. Never move the unit when it contains hot oil, liquids or hot foods.
15. Use extreme caution when working near the hot pieces and the Heating Element after using Rotisserie as these parts become (and remain) very hot. Also use maximum care when removing Drip Tray or disposing of hot grease or other hot liquids.

16. When using the Rotisserie Baskets, be sure no small bones or other food can fall between or extend beyond the wires and catch on the Drip Tray or Heating Element or anything else during rotation. It is important to check while cooking. If the food moves around inside the Basket, stop the machine. Put Oven Gloves on and carefully take out the Basket. Tighten the lid down further so the food can't move or slip around in the Basket as it rotates. The Basket gets hot so please use caution.
17. Do not clean with a metal scouring pad. Pieces can break off the pad and touch electrical parts, creating a risk of electrical shock. In addition, scouring pads may damage Rotisserie finish or the nonstick parts.
18. Do not use appliance for other than its intended use.
19. Oversized foods or metal utensils must not be inserted in the appliance as they may create a fire or risk of electrical shock.
20. Do not cover crumb/drip tray or any part of the oven with metal foil. This will cause overheating of the oven.
21. Front, back, top, bottom and side surfaces become very hot. Do not allow contact with any objects. A fire may occur if the Rotisserie is covered or touching flammable material, including curtains, draperies, walls, and the like, when in operation.
22. Do not place or store any objects or material other than foods and manufacturer's recommended accessories in the Rotisserie. Do not place or store anything on top of the Rotisserie when plugged.
23. Unplug unit before changing/replacing the interior light bulb (25 watt small appliance bulb).
24. Polarized Electrical Plug: To reduce the hazard of potential shock, this item has a polarized plug (one prong is wider than the other), which will fit only one way in a polarized outlet. If the plug does not fit the outlet properly, turn the plug the other way; if it still does not fit, contact a qualified electrician for assistance. Never use this plug with an extension cord unless it fits properly. **DO NOT ATTEMPT TO DEFEAT THIS SAFETY FEATURE.**
25. SHORT CORD INSTRUCTIONS: A short cord is provided to reduce the risks of becoming tangled in or tripping over a longer cord. Extension cords may be used if care is exercised in their use and the wattage rating is at least as great as the wattage stamped on the back of the appliance. If an extension cord is used, it should be arranged so that it will not drape over the counter or tabletop where it can be reached by children or tripped over accidentally.
26. HEAR A SQUEAK? No problem. Put a drop or two of vegetable oil on the Gear Wheel Nub before inserting the Spit Rod Assembly in the machine.

**THIS PRODUCT IS FOR HOUSEHOLD USE ONLY
SAVE THESE INSTRUCTIONS**

IMPORTANT: “Set It and Forget It”[®] only after all instructional materials (written and DVD) have been carefully followed.

Make sure food safely rotates without touching the Heating Element.

Please Don't Take “Set It and Forget It”[®] Literally

Always use caution and check on your Rotisserie from time to time.

It is highly unlikely, but if you should see or smell heavy smoke it's because the food is rubbing against the hot Heating Element. This indicates that the meat or poultry is too big or it wasn't placed properly - or the food is off-center (lopsided) on the spit rods or in the basket. If this occurs:

Turn off and unplug your machine. Do not open the Glass Door. Let it cool down.

Trim any excess fat or meat, position your food tightly in the basket and be sure the food is centered in the basket so it always rotates without touching the Heating Element.

Cleaning and Caring for your Rotisserie

BEFORE FIRST USE: Be sure the Rotisserie is not plugged in. Wash and dry the removable parts in warm soapy water. Never immerse the machine or the cord in water. Keep at least 8 inches of clearance on all sides and do not place it under a cabinet when in use. A little smoke is normal when you first use the machine.

The Glass Door: Turn lid right-side-up and insert the side lid pins into the pivot holes in the Rotisserie base (see pg 7 for diagram).

After Use: Unplug and allow it to cool before washing any parts. NOTE: The Heating Element cleans itself and no other maintenance is necessary.

The Light: The light is on when the heat is on. Replace light bulb with a 25 watt appliance bulb when needed.

Never Use Metal Cleaning Pads on the Non-stick Surfaces. They will permanently scratch the surfaces of the Grate Cover, Drip Tray, Steaming Tray, etc.

Discoloration? Some discoloration over time is to be expected when you work with hot food - especially food with fat. It's normal and will not affect the function. On white machines it gets slightly browner on the front of the machine by the Glass Lid. While not recommended, you can return your machine and, for a nominal fee, the factory will refinish the special outside surface.

Cleaning Stainless Steel (Stainless Model Only) - We recommend cleaners or wipes designed specifically for stainless steel surfaces. These cleaners are available at your local grocery or hardware store.

Any repairs should be handled only by an authorized service facility. Call Customer Service at **1-855-85-RONCO** (76626) and leave a message if after standard business hours. Or you can contact us via email at **support@ronco.com** or visit our help desk **<http://support.ronco.com>**.

ROTISSERIE MODEL SPECS

5250, 5260, 5270 Series

- Dimensions: 17.25" W x 12.75" H x 15.75" D
- 15 lb Cooking Capacity

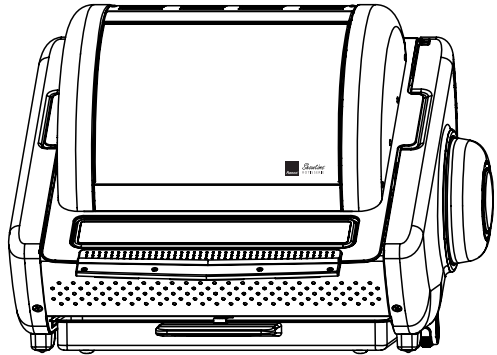

NOTE: The model number is located on the back of your E-Z Store™ Rotisserie.

UNPACKING ROTISSERIE

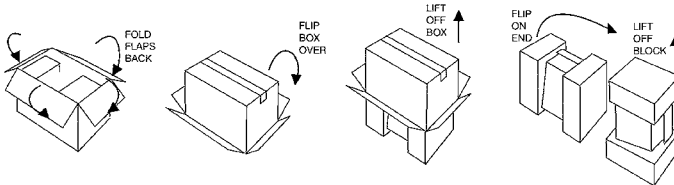

A. Fold flaps back, carefully turn box over and lift up.

B. Tip on one face of styrofoam block and carefully remove Rotisserie.

C. Carefully pull styrofoam blocks off the Rotisserie.

NOTE: All included components are located in the basket inside the Rotisserie.

PARTS INCLUDED



Glass Lid/Top

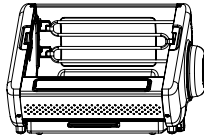

Rotisserie



Removable Drip Tray
(comes inserted in base)

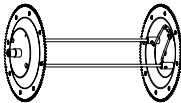

Non-stick Spit Rod Assembly
(2 Gear Wheels and 2 Spit Rods)

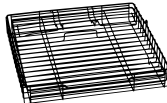

Non-stick Rotisserie Basket



Oven Gloves



Food Ties



Carving Platform
(And load the Spit Rod Assembly)



Heat Shield
(Refer to pg 8 before using)



Instructions & Recipes

GETTING STARTED: Setting Up Your Rotisserie

1. REMOVE PACKING TAPE: After you've unpacked your Rotisserie make sure you've removed all of the packing tape used to secure the Rotisserie during shipment.

2. DEPLOY REAR LEGS: The legs can be extended by pushing the small **RELEASE BUTTON** located on the right side of the Rotisserie. You will need to tilt the Rotisserie towards you so the legs can fully extend.

Helpful Hint -For your safety, the Rotisserie will only power on if the legs are in the UP-RIGHT position and the DRIP TRAY is properly inserted.

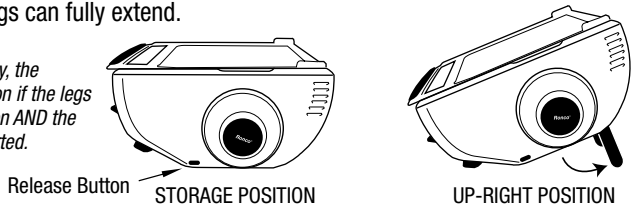

3. INSTALL GLASS LID/TOP: The lid comes packed and nested for storage. To assemble, turn lid right-side-up and insert the **LID PINS** into the **PIVOT HOLES** in the Rotisserie base as shown. You can now close the lid.

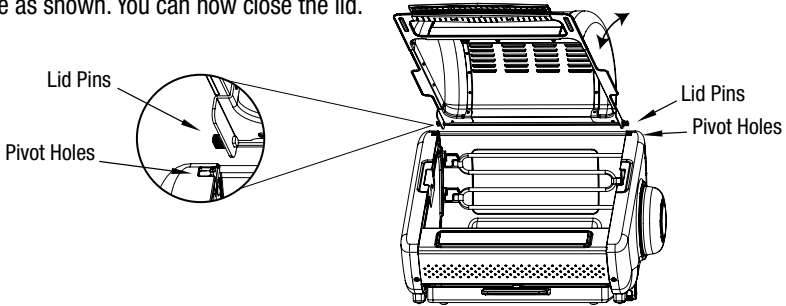

4. PROPER DRIP TRAY & HEAT SHIELD INSTALLATION: The **DRIP TRAY** must be properly inserted and in place before the Rotisserie will power on. After each use, **PRESS** the **DRIP TRAY LATCH** down to remove tray and empty grease. Never operate without the **HEAT SHIELD** in place behind the heating element. To access the **HEAT SHIELD** for cleaning, you must first remove the GLASS LID. Then slide the **HEAT SHIELD** out from the top of the Rotisserie.

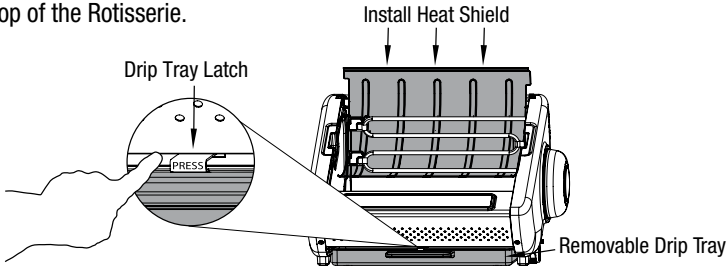

IMPORTANT: FOR YOUR SAFETY, THE ROTISSERIE WILL ONLY POWER ON IF THE LEGS ARE IN THE UP-RIGHT POSITION AND THE DRIP TRAY IS PROPERLY INSERTED.

GETTING STARTED (cont'd)

5. SPIT ROD ASSEMBLY: One end of the spit rod is held in place by a WIRE CLIP installed on Gear Wheel A. Insert the notched end of the SPIT ROD into Gear Wheel A while squeezing the WIRE CLIP together. The SPIT ROD is secure when the WIRE CLIP snaps into the notch. Repeat with second SPIT ROD. Insert pointed ends of SPIT RODS into Gear Wheel B. Place SPIT ROD ASSEMBLY inside the Rotisserie base.

CAREFUL!

Removable gear wheels (A & B) fit on the Spit Rods after food (or Basket) is loaded in place. **It is heavy and has sharp gear teeth. When carrying the Spit Rod Assembly always carry Gear Wheel B upward so it won't fall off.**

Use **CAUTION**. Tips are sharp. Please be very careful with your hands when loading any food onto the Spit Rods.

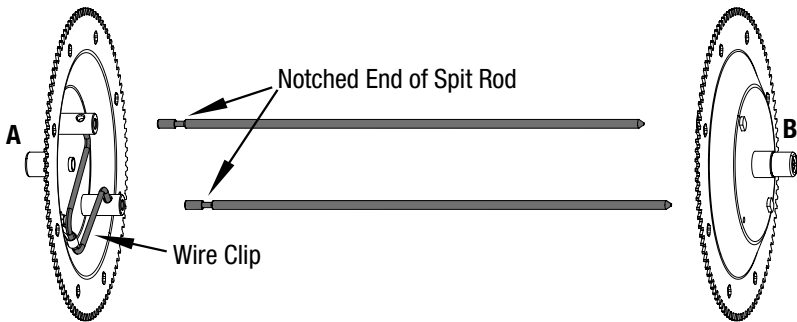

IMPORTANT:

Before First Use, be sure the Rotisserie is not plugged in. Wash and dry the removable parts in warm soapy water. Never immerse the machine or the cord in water. Keep at least 8" (inches) of clearance on top and 8 inches all sides and do not place it under a cabinet when in use. A little smoking is normal the very first time you use your machine.

Read the retain this instruction booklet for future reference regarding instruction and safeguards.

Never cook foods larger than recommended for your model of E-Z Store™ Rotisserie.

CAUTION: Keep at least 8" clearance all around from walls, cabinets and other objects when using the rotisserie to prevent heat damage. Don't put charcoal briquettes, hickory chips or anything else in the machine that is not authorized by Ronco Holdings, Inc. Do not use under cabinets. ROTISSERIE IS HOT!



Always use CAUTION with Hot Food and Metal Parts. The Food, Basket and the Spit Assembly get HOT! Always wear protective gloves when removing the Basket. If you feel the Oven Gloves are not insulated enough to adequately protect you from the hot surfaces you are handling, set whatever you are holding down immediately and wait until the food and the metal parts cool down. You may want to use a thicker oven glove or mitt.

Rotisserie Basket

Perfect for hamburgers, chicken pieces, vegetables, whole fish and fish fillets, steaks, chops, cutlets and smaller flat roasts.

After putting the food in the Basket, compress the Basket lid very tightly so no food can move, whatsoever. This can be done by compressing the lid further. **CAUTION:** The Basket gets hot.

Be sure nothing extends out between the wires. Make sure wings are all secure inside the Basket with no parts hanging out so they can't slip out and hang up on Drip Tray or Heating Element.

You can use a small **strip of aluminum foil inside the Basket on the top and bottom edges** (the edges that rotate near the Heating Element) to keep the tips of the wings from burning.

Set the Spit Rods in the Carving Platform. Line up the two small loops on the Basket with the Spit Rods. Then drop the Basket down on the Spit Rods, and match it to the corresponding loops on the other end of the Rotisserie Basket.

Check the Basket occasionally and be sure the food is still tight. If not, stop the machine and carefully take out the Basket and tighten the lid.

When the food in the Basket is done, you can remove the Basket by keeping it in a horizontal position.

REMEMBER THE FOOD, SPIT ROD ASSEMBLY AND THE BASKET ARE ALL HOT – TAKE PRECAUTIONS.

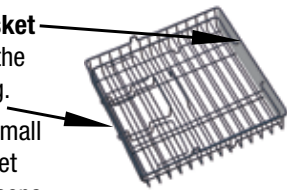

Always use CAUTION with Hot Food and Metal Parts. The Food, Basket and the Spit Assembly get HOT! Always wear protective gloves when removing the Basket. If you feel the Oven Gloves are not insulated enough to adequately protect you from the hot surfaces you are handling, set whatever you are holding down immediately and wait until the food and the metal parts cool down. You may want to use a thicker oven glove or mitt.

How to Tie Chicken

Elastic **Food Ties** are designed to be an easy-to-use method of securing poultry on the Spit Rods. It is very important when using your E-Z Store™ Rotisserie that food is securely tied and fits onto the Spit Rods so that the food will not touch the Heating Element and is evenly centered all around.

It is recommended that you cut off the tail from the chicken and remove any excess fat or loose hanging parts – especially around the main cavity so heat can enter inside the chicken while it's cooking.

The illustration shows how to tie a bird with one or two ties.



Start Breast Side Down

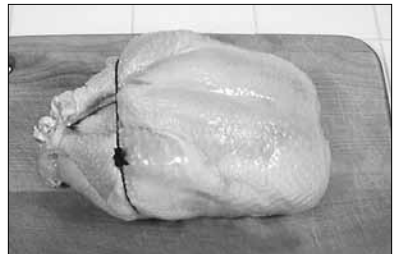
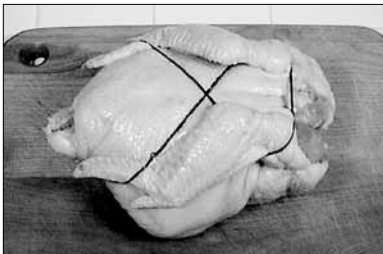
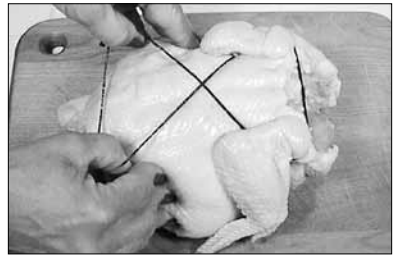

Finish Breast Side Up

How to tie a chicken using 1 tie

With one tie you go behind each wing, cross over the back and pull it over the bottom of the bird and up the front to hold the legs together. Then tuck the wings inside the tie.

If a Food Tie is too long, you can shorten it by tying a knot in it and cutting off the excess with scissors.

How to tie a chicken using 2 ties

Using two ties, shorten them both and put one over the wings and one over the legs. It's very easy.

You can also use several Food Ties to secure any bird. If you run out of Food Ties you can use butcher's twine until you can order more Food Ties.

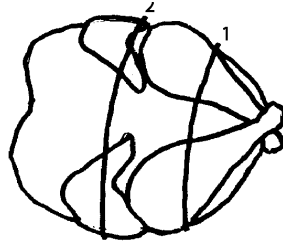

How to Tie Turkey

Tie your turkey right: make it tight! When preparing a Turkey, the wings and legs must be tied down securely to prevent them from touching the heating element.

REMEMBER: You must use Heavy Twine or String when fixing your Turkey. DO NOT use the elastic Food Ties. Keep the cavity open to heat.

Stuffing Rotisserie poultry is not recommended.

Depending on the model of your rotisserie, you will only be able to cook a certain size turkey. Please see below:

EZ-Store Rotisserie Series

- Dimensions: 17.25" W x 12.75" H x 15..75" D
- 15 lb Cooking Capacity

As your Turkey rotates, the wings and legs do have a tendency to bow out. It is VERY IMPORTANT that you follow these instructions to make sure that no part of your Turkey touches the Heating Element!

MAKE FOUR OR FIVE TIES WITH HEAVY STRING OR TWINE!

(FOR BEST RESULTS WET THE STRING OR TWINE BEFORE USE)

TIE YOUR TURKEY IN FOUR OR FIVE SPOTS:

Two ties over the Wings, One or Two ties over the wide part of the Drumsticks, and One tie over the Legs, as shown above. Be sure that nothing hangs over or extends beyond the Gear Wheels. Always center your Turkey on the Spit Rods.

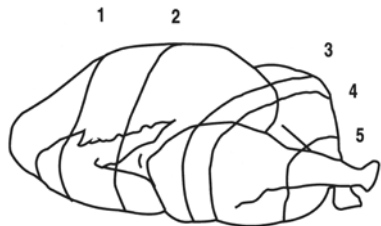

REMEMBER TO TIE EACH STRING AS TIGHTLY AS POSSIBLE.

If any part of your Turkey (or any game bird or other food) Touches the Heating Element while cooking, **IMMEDIATELY TURN OFF YOUR ROTISSERIE** and re-tie the Bird more securely. If, after re-tying, any part of your Turkey is still touching the Heating Element, the bird is too big and must be trimmed down, where necessary.

Placing Poultry on the Spit Rod Assembly

There are two ways to load the Spit Rods.

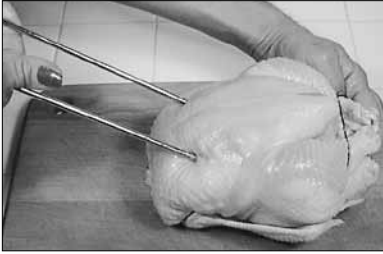

Keep hands clear of pointed rods as they exit from the meat.

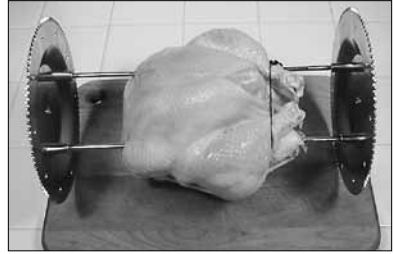

Piercing Poultry with Rods Hold the tied poultry or meat down securely with one hand while firmly pushing the Spit Rods into the bird, through the meaty portion of the breast area. The Spit Rods are sharp so always be careful not to puncture your hand.

When inserting the Spit Rods, push at a slightly downward angle and then level out the Spit Rods so that they go through the breast and exit the bird on the other side at approximately the same level. (Note: You should gently squeeze the legs of the bird together when pushing the Spit Rods through the bird.)



Carving Platform to Load Chicken



Carving Platform to Load Chicken Try putting the food on by using the Spit Rods in the Loading Base and put the chicken on breast first using gravity to help. Be sure you center the food within the area of the two Gear Wheels. Also balance the food so the weight is evenly distributed.

After the food is held securely on the Spit Rods, put the other Gear Wheel in place.

The Spit Assembly can now be placed in the rotisserie. See diagram at the bottom of the page for more information about Cooking Position.

Small Chickens or Game Hens Side-by-Side

You can also rotate two small chickens or game hens side-by-side. Place Spit Assembly in vertical position with platform underneath. Push the birds on the Spit Rods through their centers, and pierce wing to wing. Place the first tied chicken on its side and run both Spit Rods through it. Duplicate this method for the second bird. Leave a little space between the two birds so they can brown faster and more evenly. Keep all parts within the Gear Wheels and centered all around.

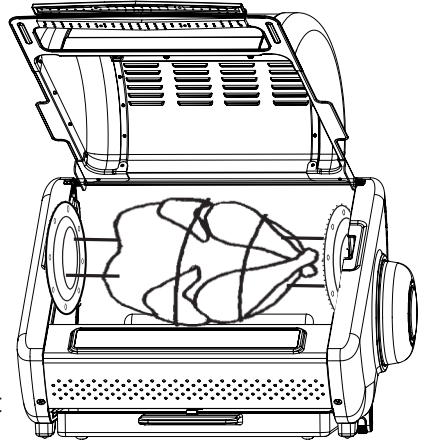

Cooking Position

The Spit Rods can go to **Position A** for normal size foods. Use **Position B** for small foods and Basket to cook them closer to the Heating Element.

Use **Position B** for a single chicken 3-1/2 lbs. or less. Tie it tightly. If any piece touches the Heating Element while rotating, move it down to **Position A** and add a bit more time.

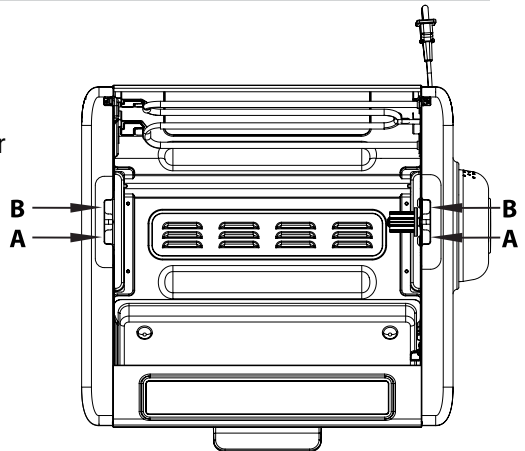

- A** – for Normal Sized Foods
- B** – for Small Foods and/or Speed Basket - Closer to the Heating Element

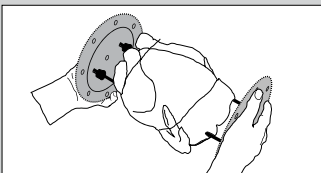

CAUTION: To prevent a wheel from accidentally falling off, always carry the end with the Removable Wheel held slightly higher. The wheels are heavy and have sharp gear teeth.

Loading the Spit Rod Assembly

IMPORTANT: Food must be centered.

Put the Spit Rods through center of the food so it will be balanced and the food does not touch the Heating Element as it rotates. This is important for large foods like turkeys, standing rib roasts, 2 chickens side-by-side or any large piece of meat that goes directly onto the Spit Rods. Small foods and pieces go in a Basket.

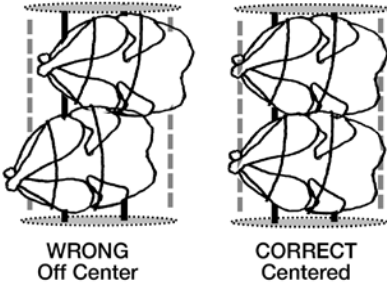

Trim off excess fat and skin or loose pieces – especially around poultry cavities so heat can enter as it cooks.

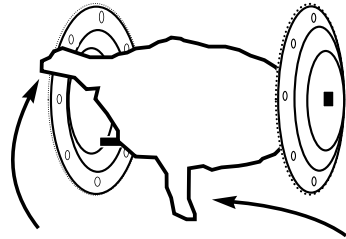

Trim turkeys, standing rib roasts and other large food to be sure nothing (bones, meat or skin) hangs over or extends beyond the Gear Wheels. Cut off excess and tie it down with string as necessary. Only turkeys up to 15 lbs. in the full-sized models. Keep center cavity clear so heat can enter while it cooks.

Roast

Standing Rib Roasts should always be loaded with the bones on the left side opposite from the small turning gear on the right side and the heavier meat on the right side. Also put the Spit Rods through meat between the bones.

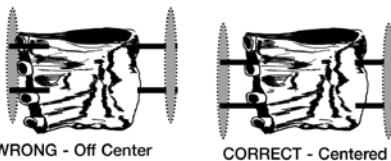

Rib Bones Always to the Left and Parallel to the Spit Rods! - Up to 8 lb. Roasts Only

When loading a rib roast start through the fat, meaty end and move the Spit Rods between (or on top of) the bones. Keep the meat evenly distributed on the Spit Rods. It may take a couple of tries to not run into a bone.

If any food scrapes or hangs up, stop immediately. Trim with scissors and reload the Spit Rods so that nothing touches the top, bottom, sides or Heating Element.

Digital Timer

EZ-Store Rotisserie Timer

Push the ON/OFF button to turn on. Press the HOUR button to set the hours of cook time. Press the MIN button to set additional minutes for your cook time. Automatically shuts off after the allotted time and a bell sounds. Always push the ON/OFF button (if the unit is still running) before removing food. The ON/OFF button will stop all functions.

Oven Light Heat Indicator – When the heat coils are getting hot, the oven light will be on. The timer must be ON for the heat to be on.



Cook Settings

ROAST: Normal rotation with heat. Use this setting to rotisserie food. This function will be automatically selected first.

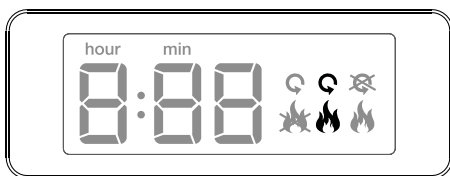

NO HEAT: Rotation without heat. Use for up to 20 minutes after cooking to keep the juices evenly distributed before serving.

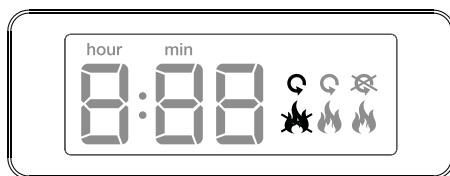

SEAR: Pause to SEAR (Heat with NO rotation). Use this function to sear steaks and brown food in front of the Heating Element. Great for food in the Baskets.

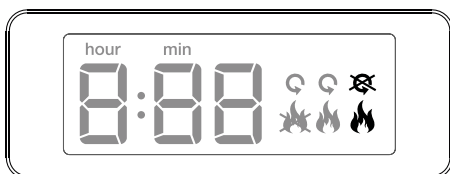

Carving Platform

After your roast, leg of lamb, or ham is done, you can place **the Carving Platform under the Gear Wheel** to hold the Spit rod assembly in a vertical position while you carve the meat. And, if you want the roast browned further, you can put the roast back in the Rotisserie - even after you've carved some off.



Always Innovating

Call for order information

1-855-85-RONCO

Visit us online at www.Ronco.com for more information and product availability or email us: support@ronco.com

Call the Order Desk to order supplies, 7 Days a Week (Leave phone message after standard business hours)

IMPORTANT: The times and temperatures given in this booklet are only a guide for your reference. Times can vary due to differences in meat shape, size, fat content, presence of bone, and electrical outlets. Use a cooking thermometer inserted into the center of the thickest portion of the meat to determine internal temperature and doneness. Remember to use Position B for small foods.

Estimated Time and Temperature Chart

The times and temperatures given in this booklet are only a guide for your reference and are based on foods at room temperature (not cold foods). Times can vary due to differences in meat shape, size, and the amount of fat and bone. Also times can vary depending on the electricity in your home – and it can even vary when plugged into different electrical outlets. The most accurate method of determining if your food is done is using a thermometer inserted into the center of the thickest portion of the meat. NOTE: If poultry exceeds 180° (internal temperature) your poultry will become drier and less juicy. Remember to use Position B for small foods.

FOOD	(QTY.) WEIGHT	EST. TIME	INTERNAL TEMP
POULTRY			
Whole Chicken or Duck	5 lbs.	15 min/lb.	165°
2 Chickens or Ducks	4 lbs. each = 8 lbs.	10 min/lb.	165°
Cornish Hens (side by side)	2-4 lbs. total	10 min/lb.	165°
Pause-to-Sear (breast stopped in front of Heating Element) @ 4 min - browner breast if necessary			
Whole Turkey	Up to 15 lbs.	12-18 min/lb.	165°
Chicken Pieces	3 lbs. (about)	45 minutes	165°
Turkey Burgers	1 ¼ lbs.	30-35 minutes	165°
Chicken Kabobs	8 Kabobs	30-35 minutes	170° Well
PORK			
Baby Back Ribs (Parboiled 15 min)	1-3 racks	35 min total	160° Med 170° Well
Rolled Pork Lion	up to 8 lbs.	18-25 min/lb.	160° Med 170° Well
Pork Tenderloin	1 ¾ - 2 lbs.	30-35 min/lb.	160° Med 170° Well
Pork Chops	4-6 chops	30-40 min total	160° Med 170° Well
Boneless Pork Chops	6 chops	25-30 min total	160° Med 170° Well
Boneless Ham (cooked)	3 lbs.	13 min/lb.	140°
Italian Sausages			
uncooked	up to 16	30-35 minutes	
cooked	up to 16	20-25 minutes	
Hot Dogs	up to 16	10 minutes	
BEEF			
Standing Rib Roast	up to 8 lbs.	18 min/lb.	145° Med
Roast	up to 8 lbs.	16 min/lb.	140° Rare
		18 min/lb.	160° Med
		20 min/lb.	170° Well
Steaks	1 ¼" thick	20 min total	Med
Hamburgers (9)	¼ lb. each	20-30 min total	Med
Beef Kabobs	8 Kabobs	20-25 min total	Med
LAMB			
Leg of Lamb	up to 8 lbs.	18-22 min/lb.	160° Med
SEAFOOD			
Salmon Steaks (Basket)	4-6 steaks 1 ¼" thick	20-25 min total	
Fish Fillets (Basket)	¾" thick	25 min total	
	thin	18 min total	
Shrimp Kabobs	6 Kabobs	20-25 min total	
Halibut Fillets (Basket)	¾" thick (breaded with dill)	30 min total	

Temperatures based on USDA Food Safety and Inspection Service Guidelines. Power and energy or rotations may vary based on voltage and speed of the basket.

AVAILABLE ACCESSORIES

Liquid Flavor Injector (Optional Accessory)

For poultry meat and seafood, just add your favorite liquid, or one of Ron's marinades, for the best flavor you've ever had. Mix with water, juice, wine, soy sauce, vinegar, olive oil, etc. Be creative, use the flavored marinating liquids of your choice.

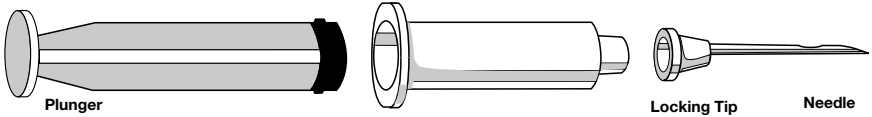

- 1) Remove the Locking Tip hidden inside the Plunger.
- 2) Load Plunger into Cylinder. Note: Keep a couple of drops of olive oil or vegetables oil on the back stopper to keep it moving smoothly.
- 3) Snap Locking Tip to the head of Cylinder.

How to Load Injector

For Liquid: Draw back Plunger to pull liquids into the Cylinder section.

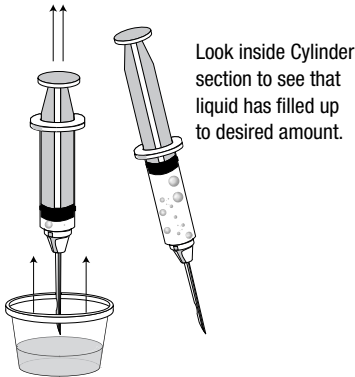

Important Safeguards

Keep all parts clean. Use warm water to clean. Mild bleach can be added to help reduce bacteria too. To clean a clogged needle, soak and use a cotton swab or fine brush.

Discard used marinade. It can carry bacteria. Never use leftover marinade on cooked meat or poultry after the marinade has had contact with uncooked meat or poultry. Should your needle stop or clog when using, you will need to make a finer marinade. Use the blender to make smaller particles.

If you inject against bone, it will seem stuck. Move the needle to one side and continue.

If you let the meat or poultry sit to marinate, refrigerate until ready to cook the food.

**CAUTION: FOR FOOD PREP ONLY.
KEEP AWAY FROM CHILDREN.**

Solid Flavor Injector (Optional Accessory)

This expanding tip injector can be loaded with pieces of garlic or diced onions, herbs, spices, diced peppers, fruit pieces or diced ham for flavoring. For pastries try inserting chocolate chips, sprinkles, nuts and other seasonings.

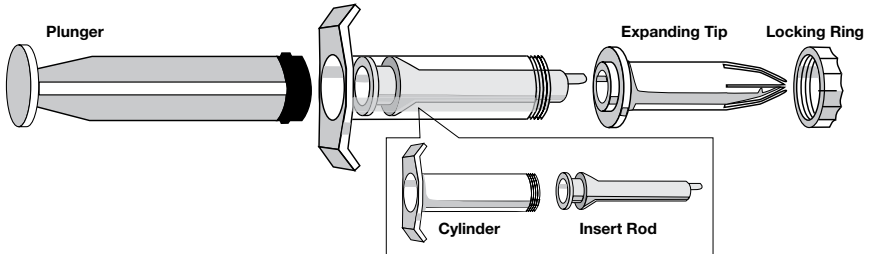

- 1) Load the Expanding Tip with garlic, fresh or dried herbs, nuts or other solid food items.
- 2) Insert the filled Expanding Tip inside the Locking Ring.

- 3) Place the Insert Rod inside the injector Cylinder. Plunger should be pulled back as far as it can go. The Insert Rod is used to push the spices through the Expanding Tip.

- 4) Inject meat, poultry or pastry with small pieces of solid food then withdraw the whole Injector. Pull the plunger back. Repeat as necessary.

How to Load Injector

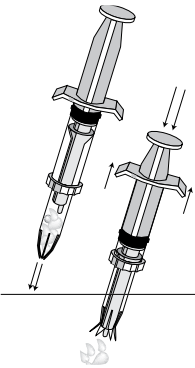

To inject small whole garlic cloves, fresh herbs or seasonings into meat or poultry, you must first insert the filled Expanding Tip as deep as it can go into the food, then depress the plunger.

Depress plunger while tip is inserted into the meat (or pastry). Withdraw the injector then pull the plunger back, reload the Expanding Tip and repeat throughout the meat or poultry.

Difficulty in piercing through tough skin, heavy fat or tough meat? Start a slit (about 1 ½" deep) into the meat with the point of a small knife.

**CAUTION: FOR FOOD PREP ONLY.
KEEP AWAY FROM CHILDREN.**

Important Safeguards

While inserting this Solid Flavor Injector into meat, poultry, or any other food, be careful not to push Injector into your hand. The Expanding Tip is sharp.

Wash Injector thoroughly with soap and water after each use. Meat and poultry residue is unhealthy and can cause the expanding Tip to crack or break.

If the Injector seems too large for your hand, fill the Expanding Tip only ½ or ¾ full (then the plunger is less extended and will fit smaller hands).

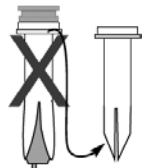

Always store the Expanding Tip empty.

Important: Please don't leave the Insert Rod in the Expanding Tip. It can stretch.

After each use, pull plunger all the way back and then retract the Insert Rod from the Expanding Tip by tapping the point down gently onto a smooth, hard surface.

Kabob Rods (Optional Accessory)

Set the completed Spit Rod Assembly in the Rotisserie, Position A (see page 13). Load the Kabobs with food then insert them into the holes on the gear wheels. Start with sharp end on the left side, then load and snap the Kabob with the Auto Turn Mechanism (spring ends) on the right so they will rotate. Turn the Spit Rod Assembly until all the Kabobs are loaded in place. Slide the whole assembly back to the next notch - the cooking position.

When done, carefully move the Spit Rod Assembly back to the Rest Area. Use Oven Gloves to remove the Kabob Rods. Simply push the spring end inward and then pull the rods out one at a time.

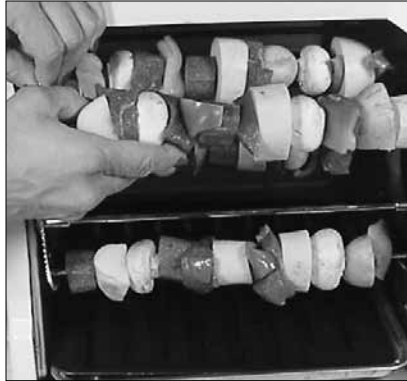
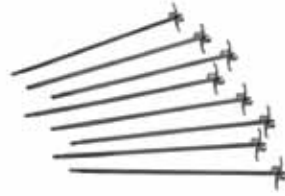

Large Multipurpose Basket (Optional Accessory)

The Large Multipurpose Basket is designed to handle extra thick foods like turkey breasts, super thick T-bone steaks, lobsters and an assortment of vegetables.

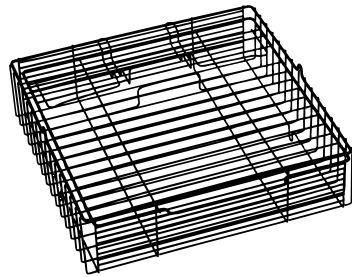

Carving Knife (Optional Accessory)

This is the all-purpose knife that can do just about anything you ask of it. Slice, chop, dice and stay sharp with the lifetime edge. The tip is used for picking up and serving small pieces of meat. Use it when you want to dice and slice without having your hand hit the counter. Use for all vegetables and fruits. Use a gentle sawing motion. Remember to always use caution with knives.

Overall length 14-3/8".



Always Innovating

Call for order information

1-855-85-RONCO

Visit us online at www.Ronco.com for more information and product availability or email us: support@ronco.com

Call the Order Desk to order supplies, 7 Days a Week (Leave phone message after standard business hours)

Round BBQ Rib Basket (Optional Accessory)

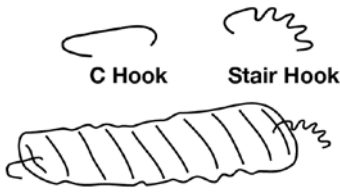

1. Place baby back or spare ribs in boiling water for 15 minutes. Drain ribs and let them cool. This step makes the ribs more pliable and tender and reduces fat. When cooled, cover both sides of the ribs with BBQ Seasoning.

2. Position hooks over the middle of the last rib bones. Attach a **C Hook** at one end of the slab and attach a **Stair Hook** at the other end.

3. Thread the **Spit Rod Assembly** through eyelets on both ends of the **Rib Basket**. Then attach the removable wheel. Position the **Spit Rod Assembly** with the **Rib Basket** in the **Rest Area**.

4. Starting with the **C Hook** end, attach the ribs to the basket on any horizontal wire. Rotate the basket while wrapping the ribs around the outside of the basket.

After ribs are stretched tight, lock the slab down by attaching the **Stair Hook** on the closest horizontal wire on the **Rib Basket**. Make sure it is tight.

5. Close the **Rotisserie Lid** and set the timer for 35 minutes on **ROAST**. While rotating, check to make sure the ribs are not touching the heating element or the glass door. If they touch, trim the ribs. Always check on your food from time to time.

6. Brush ribs with one coat of BBQ Sauce onto the ribs 10 minutes before they are done.

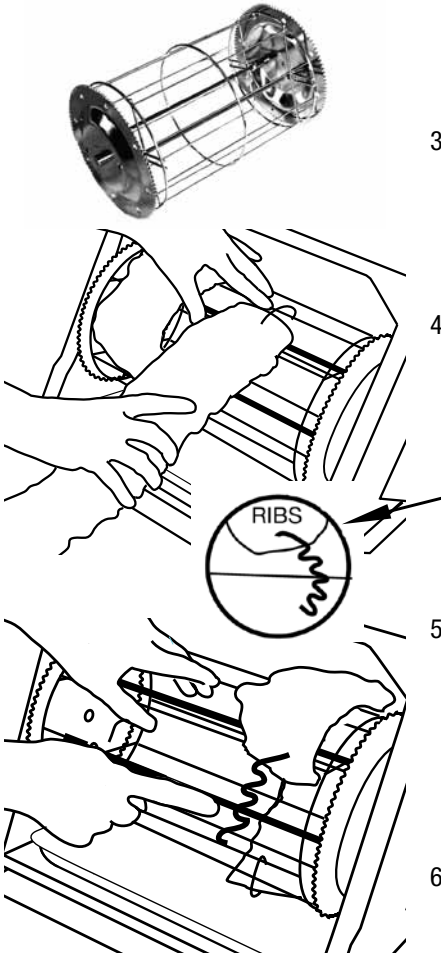

CAUTIONS

⚠ **Never use any aerosol sprays** of any kind inside the unit.

⚠ **Never cook foods larger** than recommended in the booklet for your Rotisserie.

⚠ **Grease Flicker?** Foods with high fat content can produce a small flicker of flame as fat spatters off the Heating Element. This is normal. However, if you see smoke or fire, turn off and unplug the machine and let it cool off. **DO NOT OPEN THE DOOR** until it has cooled down. **NEVER PUT WATER IN THE ROTISSERIE - Water and fat or oil don't mix.** After it has cooled, check to see if food touched, or hung up on the Heating Element.

⚠ Keep out of reach of children.

⚠ **DO NOT MOVE** rotisserie when it is hot or loaded with food.

⚠ Always keep at least 8" (inch) clearance all around the rotisserie from walls, cabinets and other objects when in use to prevent heat damage.

⚠ Do not use under cabinets.

⚠ Do not put charcoal briquettes, hickory chips or anything else in the machine that is not authorized by Ronco Holdings, Inc.

⚠ **Rotisserie is HOT!**

Glass Door, top, back and sides of the Rotisserie, as well as the Dual Heating Tray, Drip Tray, Heat Shield and Heating Element all get very hot during use and retain heat after use. Always use adequate oven mitts or gloves when handling these hot surfaces and when checking hot foods. **Wait until the Rotisserie has completely cooled before emptying Drip Tray.**

⚠ **Empty Drip Tray - TRAY AND GREASE WILL BE HOT!**

Once the Rotisserie is cool to the touch, empty the Drip tray. The tray should be emptied after each use. **PRESS** on the latch to release the Drip Tray.

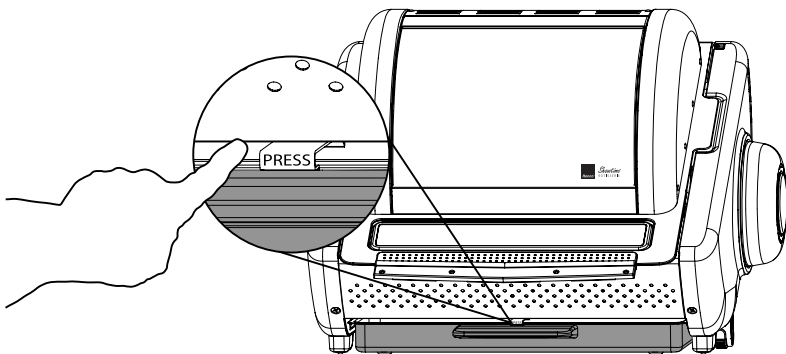

Helpful Hints

Burnt Edges on Food? You can put a small strip of aluminum foil on the top and bottom edges inside the Basket to prevent burnt edges as it cooks.

Seasonings and spices should be sprinkled on or rubbed into the food before it goes into the Rotisserie.

Once the food is rotating, **watch it to be sure nothing is touching the Heating Element** as it goes around.

Have your **food at room temperature** when it goes in. Not chilled. Wash food in warm water inside and out. **DO NOT LEAVE OUT AT ROOM TEMPERATURE MORE THAN 1 HOUR.**

It is **not necessary to preheat** the Rotisserie.

Never cook foods larger than recommended in the booklet for your Rotisserie.

Avoid burning – Baste with BBQ sauce only during the last 5 minutes. It's tasty and delicious.

Wrap fish with seasonings and marinade in aluminum foil (triple-fold the edges) and put tightly in the Basket for a delicious and easy meal!

Be sure wings are all secure inside the Basket with **no parts hanging out**.

You can **use a small strip of aluminum**

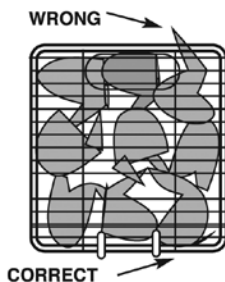

foil inside the Basket on the top and bottom edges (the edges that rotate near the Heating Element) to keep the tips of the wings from burning.

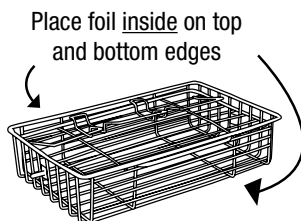

Always Innovating

Call for order information

1-855-85-RONCO

Visit us online at www.Ronco.com for more information and product availability or email us: support@ronco.com

Call the Order Desk to order supplies, 7 Days a Week (Leave phone message after standard business hours)

Meal Suggestions

Here is a list of food that requires little prep to have a fantastic meal with your E-Z Store™ Rotisserie.

Poultry:

- 1 or 2 Seasoned Chickens
- Turkey - up to 15 lbs.
- Cornish Game Hens or Ducks
- Wild Game - Venison, Goat , Fowl
- Spicy Chicken Wings (basket)
- Lemon Herb Chicken Breasts (basket)

Beef:

- Prime Rib Roasts- up to 8 lbs.
- Carne Asada Burritos
- Fajitas - Beef Strips with Bell Peppers and Onions
- New York Steak with Asparagus (basket)
- 9 Old Fashion ¼ lb. Hamburgers
- Chicago Style Hot Dogs
- Ribs (BBQ Rib Basket)

Pork and Lamb:

- Leg of Lamb Rolled in Rosemary and Olive Oil - up to 8 lbs.
- Pork Loin or Shoulder Roast - up to 8 lbs.
- Country Honey Glazed Ham
- Ribs (BBQ Rib Basket)
- Pineapple Teriyaki Pork Chops (basket)
- Apple Cinnamon Pork Chops (basket)
- Lamb Chops with Bean Salad (basket)
- Sausages (basket)

Fish and Seafood:

- Cajun Fish (basket)
- Fish with Pineapple Cilantro Sauce (basket)
- Halibut with Eggplant (basket)
- Shrimp or Scallops with Tarragon Mustard Dressing (basket)

Vegetables:

- Mixed Vegetables (basket)

Kabobs:

- Chicken, Lamb, Beef, Seafood with Vegetables

NOTE:

Inner Oven dimensions are:
12.05" W x 11.38" H x 9.40" D.
Standard basket dimensions are:
9.25" L x 9.50" W x 1.50" H.

We have provided you the dimensions of the above to help you also in figuring out the size of the turkey/chicken/roast to use. The baskets are designed so that they will not touch either the Heat Element or the Glass Top/Lid when in rotation. So, the outer contour of the potential bird or meat cut should not exceed the rectangle made by the boundary of your basket.

For example, the maximum "weight" of a bird (chicken or turkey) to grill with the EZ-Store Rotisserie is 15 lbs. However, you need to be mindful of the "volume" as well. Please note that the length of the chicken should not exceed 9.50" (which represents the distance between the gear wheels) while the width to be at 9.25" or less (which represents the depth allowed to occupy without having the chicken touching the heat element on the back wall or the glass door at the front during rotation.)

NOTE: The model number is located on the back of your E-Z Store™ Rotisserie.

Recipes

Roast Chicken with Lemon Herb Rub

One 3½ to 4 pound Whole Chicken
Rind of 2 Lemons, minced
5 Garlic Cloves, minced
1 tablespoon Dried Thyme, finely crumbled
2 teaspoons Dried Rosemary, finely crumbled
2 teaspoons Dried Sage Leaves, finely crumbled
Salt and freshly Ground Pepper

In a small bowl combine lemon rind, garlic, and herbs to form a slightly moist paste. Wash the chicken and dry thoroughly, inside and out. Loosen the skin across the breasts and then down around the leg and thigh using a chopstick or your fingers. Work the seasoning mixture under the skin and into the meat of the breast, leg and thighs and all over the outside skin as well. Season the cavity of the chicken with salt and pepper. Using an Elastic Food Tie, truss the chicken. Place the chicken on the Spit Rods for about 60 minutes or until the internal temperature reaches 165°F on a meat thermometer inserted in the thigh meat. Remove chicken and cut it into pieces to serve. (Tip: If you are rotating two small chickens at a time, skewer them side by side on the Spit Rods and increase the time to 1½ hours.) Serves 3 to 4.

Four Peppercorn Crusted Roast Beef

One 3½ to 4-pound Boneless Beef Rib Roast
2 teaspoons Black Peppercorns
2 teaspoons White Peppercorns
2 teaspoons Green Peppercorns
1 teaspoon Pink Peppercorns
1 teaspoon Salt

Place the peppercorns in a heavy plastic bag and crush with a rolling pin. Stir in the salt. Coat the outside of the roast with the pepper mixture. Rotisserie the roast on the Spit Rods 18 to 20 minutes per pound for rare or until the internal temperature reaches 140°F, 25 to 30 minutes per pound for medium or until the internal temperature reaches 160°F, or 35 to 40 minutes per pound for well done or until the internal temperature reaches 170°F on the meat thermometer inserted in the center. Remove and slice into ¼ inch thick slices or thinner. Serves 4 to 6.

Jamaican Jerk Pork Tenderloin

2 Pork Tenderloins (About 1 ½ to 2 Pounds Total)

2 tablespoons Chopped Fresh Cilantro

1 tablespoon Finely Minced Fresh Ginger

¼ cup Dark Rum

2 tablespoons Fresh Lime Juice

2 tablespoons Olive Oil

2 tablespoons Light Brown Sugar

1 cup Soy Sauce

½ teaspoon Nutmeg

¼ teaspoon Cayenne

¼ teaspoon Ground Allspice

¼ teaspoon Ground Cinnamon

¼ teaspoon Salt

Combine all ingredients except the pork in a flat baking dish. Reserve 1/3 of the marinade and keep it separate. Trim all fat and skin from the pork tenderloins and place them in the marinade. Turn to coat well. Cover and marinate for 15 to 30 minutes at room temperature. Cook the pork in a Rotisserie Basket for 30 minutes basting it with the marinade juices often during the last 10 minutes or until the internal temperature reaches 160°F on a meat thermometer. Slice the pork on the diagonal, place on a serving platter. Warm the reserved marinade and spoon it over the pork slices and serve. Serves 4.

Lemon Dill Salmon Steaks

4 Large or 6 Medium Salmon Steaks

¼ cup Fresh Lemon Juice

3 tablespoons Olive Oil

1 tablespoon Minced Fresh Dill or 1 teaspoon Dry Dill Weed

½ teaspoon Salt

½ teaspoon White Pepper

In a small bowl add all ingredients except the salmon. Brush on both sides of the salmon, wait 5 minutes and repeat. Place the salmon steaks in the Rotisserie Basket. Cook for 15 to 25 minutes, depending on size of salmon steaks. Serve one salmon steak per person.

Roasted Vegetable Skewers with Balsamic Basil Marinade

- 1 Red Bell Pepper, cut into 1 inch pieces
- 1 Yellow Summer Squash, cut into ¼ inch slices
- 1 Zucchini cut into ¼ inch slices
- 16 White Button Mushrooms, stems removed
- 8 Green Onions, cut into 1½ inch pieces

Marinade:

- ½ cup Olive Oil
- 6 tablespoons Balsamic vinegar
- 2 tablespoons minced fresh Basil
- 2 cloves Garlic

Prepare the vegetables and place them in a large bowl or food storage bag. Combine the marinade ingredients and pour the marinade over the vegetables. Cover and marinate 1 to 2 hours at room temperature. Drain off the marinade and skewer the vegetables on the Kabob rods. Rotate the skewered vegetables for 20 to 25 minutes until the vegetables are slightly brown, but still crunchy. Remove the Kabobs from the Gear Wheels and slide the vegetables off onto serving plates. Serves 6.

Merlot Marinated Leg of Lamb

- One Leg of Lamb (4 ½ to 5 Pounds) boned and tied
- 1 cup Merlot or other dry red wine
- ½ cup Soy Sauce
- 4 cloves Garlic; minced
- 2 tablespoons Dried Oregano
- 1 tablespoon Dried Rosemary
- 1 tablespoon coarsely Ground Pepper

Combine the soy sauce, Merlot, garlic, oregano, rosemary, and pepper in a deep bowl. Add the lamb and turn it to coat with marinade. Cover and chill at least 6 hours or up to a day, turning the meat over several times. Remove the lamb from the marinade, reserving marinade for basting. Place the lamb on the Spit Rods. Cook for 1 hour, 15 to 30 minutes or until the internal temperature reaches 160°F for medium, basting several times during the last 10 minutes. Serves 6 to 8.

Mustard-Brown Sugar Glazed Pork Chops

Three or Four 1 Inch thick Center Cut Pork chops
½ cup Brown Sugar
¼ cup Dijon Mustard
Pinch each of Dried Thyme and Dried Sage

Pat pork chops dry with a paper towel. Stir together mustard, thyme and sage. Coat pork chops well with the herb mustard. Press brown sugar into the herb mustard. Place the pork chops in the Rotisserie Basket for 30 to 35 minutes or until cooked through. If not brown enough, position the Basket facing the Heating Element and turn the switch to “Pause-to-Sear” for 2 to 3 minutes on each side. Serves 3 to 4.

Apricot-Orange Glazed Game Hens

Two 1 ½ to 2 Pound Rock Cornish Game Hens
3 tablespoons Fresh Orange Juice
3 tablespoons Soy Sauce
½ cup Apricot Preserves
Salt and Fresh Ground Pepper

Stir together the preserves, orange juice and soy sauce. Separate and reserve half of the sauce and serve it with the hens. Wash and thoroughly dry the game hens inside and out. Season the inside cavity with salt and pepper and brush the game hens with the other half of the sauce. Cook 40 to 50 minutes or until the temperature reaches 180°F on a meat thermometer. Serve with warmed reserve sauce. Serves 2 to 4.

BBQ Beef Kabobs

2 pounds Beef Top Sirloin
1 cup BBQ Sauce
2 Bell Peppers; cut in 1 Inch pieces
2 cups whole Mushrooms
1 Purple Onion, cut in 1 Inch pieces

Cut the beef into 1¼ inch cubes and place in a medium bowl. Stir in BBQ sauce; cover and let marinate for 1 to 4 hours in the refrigerator. Remove the beef from the sauce and skewer on the Kabob Rods, alternating beef with desired vegetables. Cook for 20 to 25 minutes or until they reach desired doneness. Baste with BBQ sauce only during the last 5-10 minutes. Serves 6.

Two Original Style Roast Chickens

- Two 3½ to 4 pound whole chicken
- 2 teaspoons each of Salt and Paprika
- 1 teaspoon each of Onion Powder, Dried Thyme, White Pepper
- ½ teaspoon each of Cayenne Pepper, Black Pepper, Garlic Powder
- Salt and fresh Ground Pepper
- 2 Onions, quartered

In a small bowl, mix together salt, paprika, onion powder, thyme, white pepper, black pepper, cayenne pepper, and garlic powder. Remove and discard giblets from chicken. Rinse chicken cavity, and pat dry with paper towel. Rub each chicken inside and out with spice mixture. Place 1 onion into the cavity of each chicken. Place chickens in a resealable bag or double wrap with plastic wrap. Refrigerate overnight, or at least 4 to 6 hours. **Remove onions from cavity.** Season the cavity of the chicken with salt and pepper. Using an Elastic Food Tie, truss the chicken. Place the chickens side by side on the Spit Rods for about 80-90 minutes or until the internal temperature reaches 165°F on a meat thermometer inserted in the thigh meat. Remove chickens and cut it into pieces to serve. Serves 6 to 8.

6 Easy Steps to Great Rotisserie Chicken

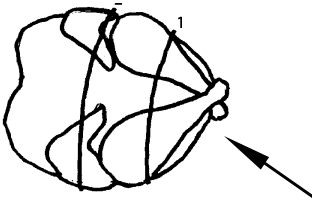

1. Wash the chicken with warm water (so the food is not cold when it goes in the Rotisserie) and remove any parts from the cavity (giblets, etc). Cut away excess fat and skin so hot air can get into the cavity.

Tie the wings and legs down. Use one or two of the Elastic Food Ties (if they are too big for your chicken, knot them smaller and cut off the excess). *See page 10 for more details.*

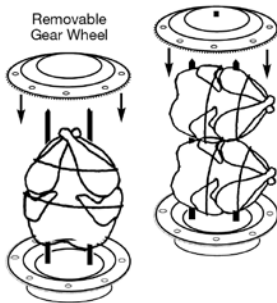

2. Place the chicken on the Spit Rods breast first - be sure it's centered and the weight is evenly distributed. Be careful to keep your hands clear of the sharp rod tips when loading food vertically or horizontally. After loading the food on the **Spit Rods**, put the other Gear Wheel on.

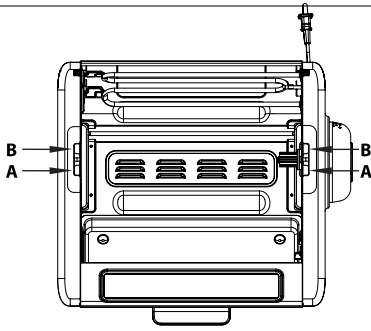

3. Place the loaded **Spit Rod Assembly** in the proper cooking position (A or B). Position A is your standard cooking position. Position B is for smaller items or the Speed Basket. Close the **Glass Lid**.



4. Set the **3-Way Function** to **ROAST**. Set the Timer for 15 minutes per pound for a chicken. Example: 4 lbs. = 1 hour.
NOTE: Use the total weight- which includes giblets that's printed on your chicken package. If your package does not include giblets, etc., then add a 1/4 pound to the actual weight of your chicken to figure the cooking time.

Problem? If a chicken wing comes free or any part touches the Heating Element or bottom grate during cooking, simply turn the Timer to **OFF**. Let it cool a bit. Please be careful – both the food and the Rotisserie get hot. Make any adjustments or re-tie your chicken. Then reset the Timer.



5. To enjoy the best flavor and taste, serve your chicken immediately. If you are not ready to serve it right away, however, press the **NO HEAT** button to continue rotating. This will keep the juices evenly distributed throughout the chicken.

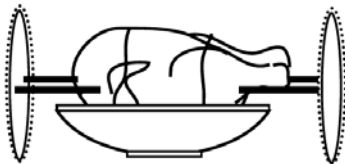

6. To Serve: When chicken is done, carefully lift the **Glass Lid**. Use the **Oven Gloves** and gently but quickly lift the chicken and **Spit Rod Assembly** out while supporting the chicken. A bowl under the chicken helps make it easier to remove. Take off the removable Gear Wheel, slide out the Spit Rods and serve.

CAUTION: The parts get really hot!

ONE YEAR LIMITED WARRANTY

Ronco Holdings, Inc., warrants to the owner of this product that it is free from defects in material and workmanship for a period of one year from date of purchase. Please visit <http://www.ronco.com/warranty.html> and fill out your Warranty Registration Form.

The manufacturer's obligation will be limited to repairing or replacing F.O.B. any part of the product which is defective. Such warranty will not apply to defects resulting from tamper, cosmetic damage, acts of God, accidental breakage, abuse, negligence, neglect or misuse. If you must return the product for reasons of malfunction within the one year warranty period, the following action and steps are required: Remit U.S. Dollars:

1. The machine must be clean and packaged securely to protect from damage or breakage in shipment.
2. Call and obtain a Return Authorization Number. Then ship prepaid to Ronco Holdings, Inc., by the most convenient method. Ronco Holdings, Inc., will repair or replace your Rotisserie unit and return it to you prepaid.

Even if not required, the rights in this warranty are granted to you. This warranty gives you specific legal rights, and you may also have other rights which vary from state to state. Registering for your warranty is not a condition precedent to warranty coverage.

Ronco Holdings, Inc., will not be held liable for any special, incidental, or consequential damage, resulting from possession, use or loss of use of this product either directly or indirectly.

No returns will be accepted without prior authorization.

To receive a Return Authorization Number Call Customer Service at 1-855-85-RONCO.
If all lines are busy, please contact our support site at <https://support.ronco.com>



Ronco Holdings, Inc.
15505 Long Vista Dr., Ste 250
Austin, TX 78728
www.Ronco.com

Copyright ©2013 by Ronco Holdings, Inc. All Rights Reserved. 01.13

Manufactured under U.S. patents: 7,424,849; 7,325,484; 7,739,948; 6,782,805; 6,782,806; 7,153,120; 6,250,214; 6,142,064; 6,988,445; 7,021,203; 6,170,390; 5,731,012; 6,874,408; 6,422,136; 6,658,991; 6,393,972; 6,240,838; 6,408,742; 6,568,315; 6,568,316; 6,253,665; 6,330,855; 7,225,729; 7,225,730; 6,536,334; 6,742,445; 7,500,428; 7,878,111; 6,837,150.

Foreign patents pending.

EZ-Store MODEL ROTISSERIE