

SAMSUNG

Product Guide

7511 Series Freestanding Electric Range

NE59T7511SS

NE59T7511SG

Available in: Stainless Steel and
Fingerprint Resistant Black Stainless Steel



Table of Contents

NE59T7511 - 5.9 cu. ft. Freestanding Electric Range with Air Fry & Convection

Product Overview

Product Overview 4

Carousel Image Order 5

Product Messaging

Features and Benefits 7

Product Specs

Related Products 11

Spec Sheet 12

User Manual and Warranty Information 13

Feature Icons

15

Product Overview

NE59T7511 – 5.9 cu. ft. Freestanding Electric Range with Air Fry & Convection

Product Overview

Product Title

5.9 cu. ft. Freestanding Electric Range with Air Fry and Convection

Product Long Description (175 characters)

Creating delicious and healthier* meals just got easy and fast with this beautiful Freestanding Electric range offering Air Fry mode & Convection.

*As compared to deep frying.

Available Colors



Stainless Steel
NE59T7511SS



**Fingerprint Resistant
Black Stainless Steel**
NE59T7511SG



Carousel Image Order

Easy Ad links

NE59T7511SS: S.com: <http://www.samsungeasyads.com/mm/nicePath/easyads?nav=pr659263419>
R.com: <http://www.samsungeasyads.com/mm/nicePath/easyads?nav=pr659263382>

NE59T7511SG: S.com: <http://www.samsungeasyads.com/mm/nicePath/easyads?nav=pr659263540>
R.com: <http://www.samsungeasyads.com/mm/nicePath/easyads?nav=pr659263539>





Product Messaging

NE59T7511 – 5.9 cu. ft. Freestanding Electric Range with Air Fry & Convection



Easy Ads links: **Stainless Steel:** <http://www.samsungeasyads.com/mm/nicePath/easyads?nav=pr659367074>
Fingerprint Resistant Black Stainless Steel: <http://www.samsungeasyads.com/mm/nicePath/easyads?nav=pr659367088>

Features and Benefits – NE59T7511

Overall Product Headline	Feature Name	Long Body Copy	Short Body Copy	Associated Image
<p>Air Fry - Healthier* Cooking with a Crunch *As compared to deep frying.</p>	<p>Air Fry</p>	<p>Cooking just got healthier* with new Air Fry mode. Using little to no oil, you can quickly prepare your favorite fried foods right in your oven. Air Fry tray included. *As compared to deep frying.</p>	<p>A healthier* way to prepare your favorite fried foods right in your oven, with little to no oil. *As compared to deep frying.</p>	
<p>Save Time with Convection</p>	<p>Convection</p>	<p>Powerful convection saves you time by cooking food fast and more evenly. Perfect for baking and roasting.</p>	<p>Cooks food fast and more evenly.</p>	
<p>Ready. Set. Served.</p>	<p>Rapid Boil™</p>	<p>Bring water to a boil quickly with the 3300 W Rapid Boil™ element.</p>	<p>Boil quickly with the 3300 W Rapid Boil™ element.</p>	



Easy Ads links: **Stainless Steel:** <http://www.samsungeasyads.com/mm/nicePath/easyads?nav=pr659367074>
Fingerprint Resistant Black Stainless Steel: <http://www.samsungeasyads.com/mm/nicePath/easyads?nav=pr659367088>

Features and Benefits – NE59T7511

Overall Product Headline	Feature Name	Long Body Copy	Short Body Copy	Associated Image
<p>Cook Enough for the Whole Crew</p>	<p>Large Oven Capacity</p>	<p>This large 5.9 cu. ft. oven fits multiple meals at one time, or it can easily accommodate big casserole dishes or roasting pans.</p>	<p>This large 5.9 cu. ft. oven fits multiple meals at one time.</p>	
<p>Flexible in Every Way</p>	<p>Flexible Cooktop</p>	<p>Get to high heat quickly for searing meat or boiling water, or turn down to a simmer to make your favorite sauces. Has 5 heating elements, including 2 dual ring elements, so you can cook with multiple sized pots and pans.</p>	<p>Get to high heat quickly for searing meat or boiling water, or turn down to a simmer to make your favorite sauces.</p>	
<p>Don't Even Think About How To Cook It</p>	<p>Easy Cook Preset Options</p>	<p>Take the thinking out of making dinner by using Easy Mode Preset Buttons. Let your Samsung Range figure out how to cook it, you decide how you want it cooked. Four Preset buttons include Air Fry, Pizza, Bread Proof, and Slow Cook.</p>	<p>Take thinking out of making dinner and use Easy Mode Preset Buttons that include Air Fry, Pizza, Bread Proof, and Slow Cook. Let your range do all the work, while you just press the button!</p>	

Easy Ads links: **Stainless Steel:** <http://www.samsungeasyads.com/mm/nicePath/easyads?nav=pr659367074>
Fingerprint Resistant Black Stainless Steel: <http://www.samsungeasyads.com/mm/nicePath/easyads?nav=pr659367088>

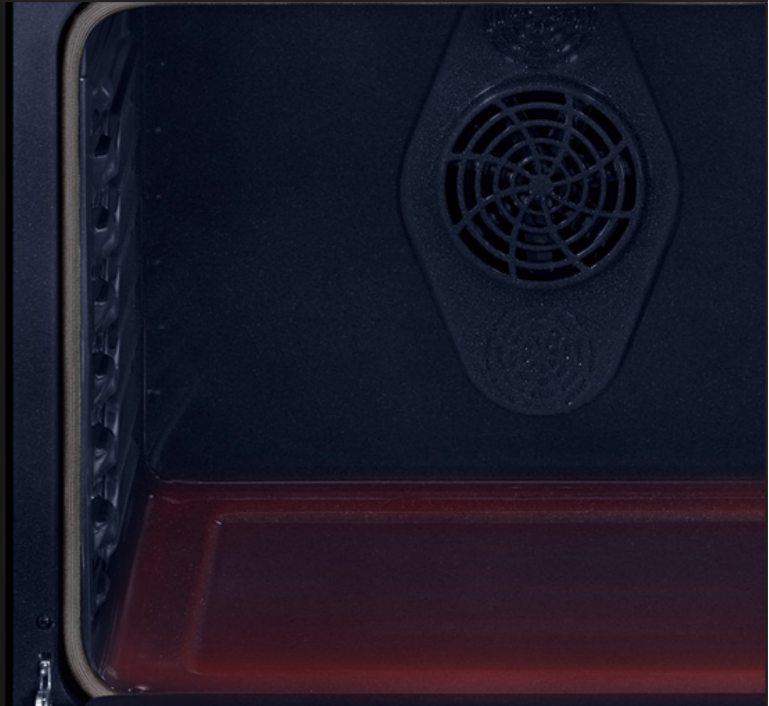
Features and Benefits – NE59T7511

Overall Product Headline	Feature Name	Long Body Copy	Short Body Copy	Associated Image
Does The Hard Work For You	Self & Steam Clean	Get help from your oven with Self & Steam Clean. The self cleaning system deep cleans by heating to a high temperature to burn off grease and food residue. Steam clean in 20 minutes for easier cleaning jobs.	Get help from your oven with Self & Steam Clean.	 <p>Before After</p>
Cleaning Is Seamless	Hidden Bake Element	The bake element is hidden under the ceramic enamel surface at the bottom of the oven. This provides a seamless cavity that makes cleaning easy.	Makes cleaning your oven easy with a seamless interior.	
Take a Peek Inside	Wide View Window	Check cooking progress in the Wide View Window without opening the door and losing heat.	Wide View Window allows you to see cooking progress without opening the door.	

Product Specs

NE59T7511 – 5.9 cu. ft. Freestanding Electric Range with Air Fry & Convection

Related Products

SKU	Type		Color(s)
NE59T7511SS/AA	Over-The-Range Microwave	ME21M706BAS/AA	Stainless Steel
	Over-The-Range Microwave	ME21R7051SS/AA	
	Dishwasher	DW80R5060US/AA	
	Refrigerator	RF28R7351SR/AA	
NE59T7511SG/AA	Over-The-Range Microwave	ME21M706BAG/AA	Fingerprint Resistant Black Stainless Steel
	Over-The-Range Microwave	ME21R7051SG/AA	
	Dishwasher	DW80R5060UG/AA	
	Refrigerator	RF28R7351SG/AA	

Spec Sheet

Easy Ads link

<http://www.samsungeasyads.com/mm/nicePath/easyads?nav=pr659326441>

NE59T7511SS

Samsung Freestanding Electric Range with Air Fry & Convection

5.9 cu. ft. Capacity



SAMSUNG

Signature Features

Air Fry

- Cooking just got healthier with new Air Fry mode* Using little to no oil, you can quickly prepare your favorite fried foods right in your oven. Air Fry tray included.
- *As compared to deep frying.

Convection

- Powerful convection saves you time by cooking food fast and more evenly. Perfect for baking and roasting.

Rapid Boil™

- Bring water to a boil quickly with the 3300 W Rapid Boil™ element.

Available Colors

- Stainless Steel (shown)
- Fingerprint Resistant Black Stainless Steel



Air Fry



Convection

Features

- Air Fry, Tray Included
- Convection
- Rapid Boil™ – 3300 W Element
- Large Oven Capacity – 5.9 cu. ft.
- Wide View Window
- Easy Cook Preset - Air Fry, Bread Proof, Slow Cook
- Storage Drawer

Convenience

- Convection Auto Conversion
- Self & Steam Clean
- Hidden Bake Element
- Child Safety Lock
- Delay Start
- Auto Oven Light
- Kitchen Timer
- Sabbath Mode



NE59T7511SS

Samsung Freestanding Electric Range with Air Fry & Convection

5.9 cu. ft. Capacity

SAMSUNG

Installation Specifications

*30" minimum clearance between the top of the cooking surface and the bottom of an unprotected wood or metal cabinet; or if no 30" minimum clearance, 24" minimum when the bottom of the wood or metal cabinet is protected by not less than 0.25" flame-retardant millboard covered with not less than no. 28 MSG sheet steel, 0.015" stainless steel, 0.024" aluminum, or 0.020" copper.

**15" minimum between the counter top and the adjacent cabinet bottom.

IMPORTANT: To eliminate the risk of burns or fire caused by reaching over heated surface units, cabinet storage space located above the surface units should be avoided. If cabinet storage is to be provided, the risk can be reduced by installing a range hood that projects horizontally a minimum of 5' beyond the bottom of the cabinets.

A. Required Cabinet Opening is 30"
B. Acceptable Electrical Outlet Space

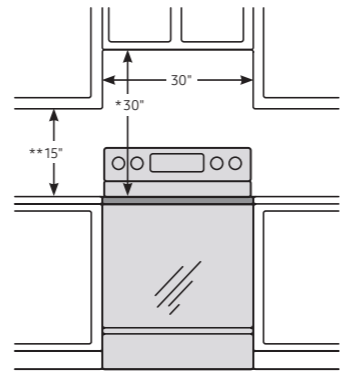

Power Source

240/208V/60Hz/40A

Electric Cooktop

- Right Front: 9"/12" Dual Element, 3000 W
- Left Front: 6"/9" Dual Element, Rapid Boil™ 3300 W
- Right Rear: 6", 1200 W
- Left Rear: 6", 1200 W
- Center: 7", Warming Center

Oven

- Capacity: 5.9 cu. ft.
- Convection Bake
- Convection Roast
- Bake
- Variable Broil: Low/High
- Air Fry
- Bread Proof
- Slow Cook

Warranty

One (1) Year Parts and Labor

Product Dimensions & Weight (WxHxD)

Actual Oven Dimensions: 25" x 21 1/8" x 19 1/4"
Outside Net Dimensions: 29 1/8" x 46 1/2" x 28 7/16"
Weight: 156 lbs

Shipping Dimensions & Weight (WxHxD)

Dimensions: 33" x 50 7/8" x 30 1/4"
Weight: 183 lbs

Color	Model #	UPC Code
Stainless Steel	NE59T7511SS	887276428420
Fingerprint Resistant Black Stainless Steel	NE59T7511SG	887276428413

Dimensions

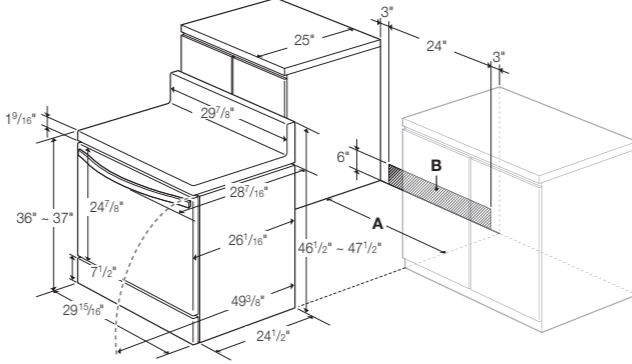

Actual color may vary. Design, specifications, and color availability are subject to change without notice. Non-metric weights and measurements are approximate.
©2019 Samsung Electronics America, Inc., 85 Challenger Road, Ridgefield Park, NJ 07660. Tel: 800-SAMSUNG. samsung.com. Samsung is a registered trademark of Samsung Electronics Co., Ltd.

Spec Sheet - front

Spec Sheet - back

User Manual/Warranty

Easy Ads link

<https://www.samsungeasyads.com/mm/nicePath/easyads?nav=pr659326441>



User Manual

Warranty (U.S.A)

PLEASE DO NOT DISCARD. THIS PAGE REPLACES THE WARRANTY PAGE IN THE USE & CARE GUIDE

SAMSUNG ELECTRIC RANGE

LIMITED WARRANTY TO ORIGINAL PURCHASER WITH PROOF OF PURCHASE

This SAMSUNG brand product, as supplied and distributed by SAMSUNG ELECTRONICS AMERICA, INC. (SAMSUNG) and delivered new, in the original carton to the original consumer purchaser, is warranted by SAMSUNG against manufacturing defects in materials or workmanship for the limited warranty period, starting from the date of original purchase, of:

One (1) Year Parts and Labor

This limited warranty is valid only on products purchased and used in the United States that have been installed, operated, and maintained according to the instructions attached to or furnished with the product. To receive warranty service, the purchaser must contact SAMSUNG at the address or phone number provided below for problem determination and service procedures. Warranty service can only be performed by a SAMSUNG authorized service center. The original dated bill of sale must be presented upon request as proof of purchase to SAMSUNG or SAMSUNG's authorized service center to receive warranty service.

SAMSUNG will provide in-home service within the contiguous United States during the warranty period at no charge, subject to availability of SAMSUNG authorized servicers within the customer's geographic area. If in-home service is not available, SAMSUNG may elect, at its option, to provide transportation of the product to and from an authorized service center. If the product is located in an area where service by a SAMSUNG authorized servicer is not available, you may be responsible for a trip charge or required to bring the product to a SAMSUNG authorized service center for service.

To receive in-home service, product must be unobstructed and accessible to the service agent.

During the applicable warranty period, a product will be repaired, replaced, or the purchase price refunded, at the sole option of SAMSUNG. SAMSUNG may use new or reconditioned parts in repairing a product, or replace the product with a new or reconditioned product. Replacement parts and products are warranted for the remaining portion of the original product's warranty or ninety (90) days, whichever is longer. All replaced parts and products are the property of SAMSUNG and you must return them to SAMSUNG.

This limited warranty covers manufacturing defects in materials or workmanship encountered in normal household, noncommercial use of this product and shall not cover the following: damage that occurs in shipment, delivery, installation, and uses for which this product was not intended; damage caused by unauthorized modification or alteration of the product; product where the original factory serial numbers have been removed, defaced, changed in any way, or cannot be readily determined; cosmetic damage including scratches, dents, chips, and other damage to the product's finishes; damage caused by abuse, misuse, pest infestations, accident, fire, floods, or other acts of nature or God; damage caused by use of equipment, utilities, services, parts, supplies, accessories, applications, installations, repairs, external wiring or connectors not supplied or authorized by SAMSUNG; damage caused by incorrect electrical line current, voltage, fluctuations and surges; damage caused by failure to operate and maintain the product according to instructions; in-home instruction on how to use your product; and service to correct installation not in accordance with electrical or plumbing codes or correction of household electrical or plumbing (i.e., house wiring, fuses, or water inlet hoses). In addition, damage to the glass cooktop caused by (i) use of cleaners other than the recommended cleaners and pads or (ii) hardened spills of sugary materials or melted plastic that are not cleaned according to the directions in the use and care guide are not covered by this limited warranty.

The cost of repair or replacement under these excluded circumstances shall be the customer's responsibility.

Visits by an authorized servicer to explain product functions, maintenance or installation are not covered by this limited warranty. Please contact SAMSUNG at the number below for assistance with any of these issues.

Warranty (U.S.A)

English 47

Warranty

Feature Icons

NE59T7511 – 5.9 cu. ft. Freestanding Electric Range with Air Fry & Convection

Feature Icons



Air Fry

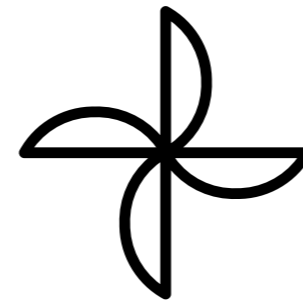

Convection

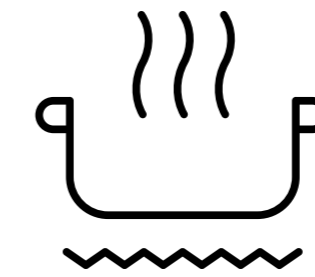

Rapid Boil™

5.9 cu. ft.

Oven Capacity

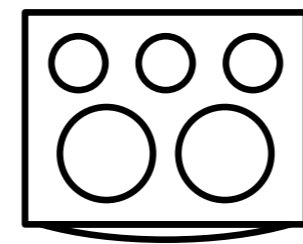

5 Element Cooktop

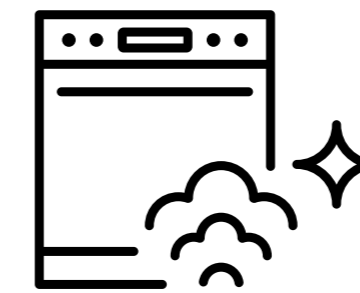

Self + Steam Clean

SAMSUNG