



Read and Save These Instructions
All Hoods Must Be Installed By A Qualified Installer

INSTALLATION INSTRUCTIONS

ISLAND RANGE HOOD

Read All Instructions Thoroughly Before Beginning Installation

WARNING - TO REDUCE THE RISK OF FIRE, ELECTRIC SHOCK, OR INJURY TO PERSONS, OBSERVE THE FOLLOWING:

- A. Installation work and electrical wiring must be done by qualified person(s) in accordance with all applicable codes and standards, including fire-rated construction. Switch power off at service panel and lock the service disconnecting means to prevent power from being switched on accidentally during installation.**
- B. When cutting or drilling into wall or ceiling, do not damage electrical wiring and other hidden utilities.**
- C. Ducted fans must always be vented to the outdoors.**
- D. Sufficient air is needed for proper combustion and exhausting of gases through the flue (chimney) of fuel burning equipment to prevent back drafting. Follow the heating equipment manufacturer's guideline and safety standards such as those published by the National Fire Protection Association (NFPA), and the American Society for Heating, Refrigeration and Air Conditioning Engineers (ASHRAE), and local code authorities.**

WARNING - TO REDUCE THE RISK OF FIRE, USE ONLY METAL DUCTWORK

Vent-A-Hood®

Ducting Do's and Don'ts

NEVER restrict the duct size. An island dual blower unit (T200) requires 8" round duct or equivalent (50 square inches). When combining ducts together, the square inch area must reflect the total square inch area of the ducts being combined. Using the included Vent-A-Hood transition(s) will ensure proper efficiency.

Blower	Duct Size	Sq. Inch Area	Vent-A-Hood Transition
Island Dual (T200)	8" round or equivalent	50"	VP565 (Included)

Do not use flexible or corrugated duct. This type of duct will restrict airflow and reduce performance. Only use smooth, galvanized, metal duct. Observe local codes regarding special duct requirements and placement of duct against combustibles. Make the duct run as short and as straight as possible with as few turns as possible. Avoid sharp-angled turns. Instead, use smooth, gradual turns such as adjustable elbows or 45 degree angled turns. For duct runs over 20 feet, increase the duct diameter by one inch for every ten feet of duct. A 90 degree elbow is equal to 5 feet of duct. Using Vent-A-Hood roof jacks or wall louvers (back page) will ensure proper efficiency. Airflow must not be restricted at the end of the duct run. Do not use screen wire or spring-loaded doors on wall louvers or roof jacks. Do not terminate venting into an attic or chimney. Where possible, seal joints with duct tape. The hood must be ducted to the outdoors without restrictions.

YES



Smooth Duct

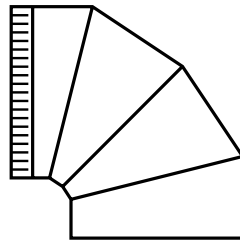

Smooth Gradual Turn

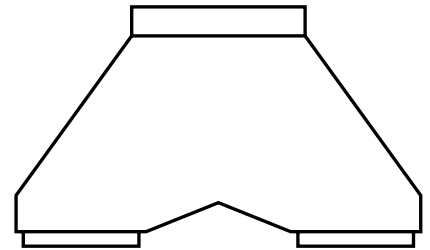

Proper Combining of Two Ducts

NO

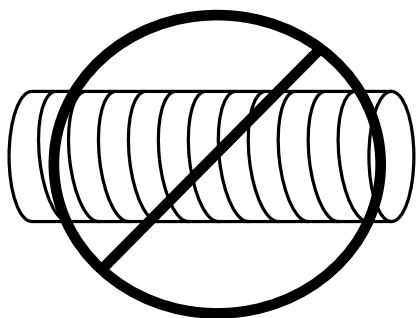

Flexible Duct

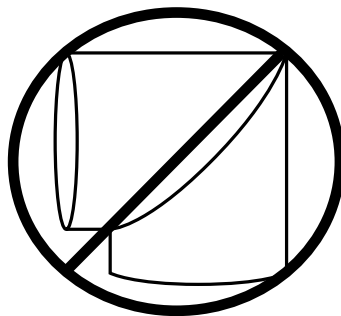

Sharp Angled Turns

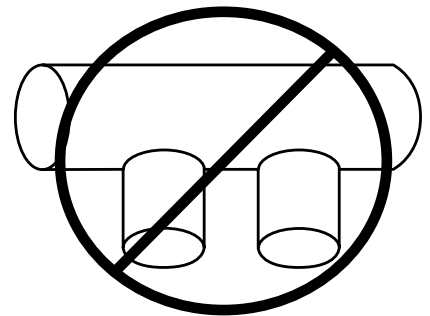

Improper Combining of Two Ducts

Vent-A-Hood®

Installation Details

- 1) Read all instructions thoroughly before beginning installation. Note: These instructions apply to standard hoods only. Custom hoods may require additional specification consideration.
- 2) When installing an island range hood, it is recommended that the bottom edge of the hood be located no more than 30" above the cooking surface. Exceeding recommended mounting height may compromise performance.

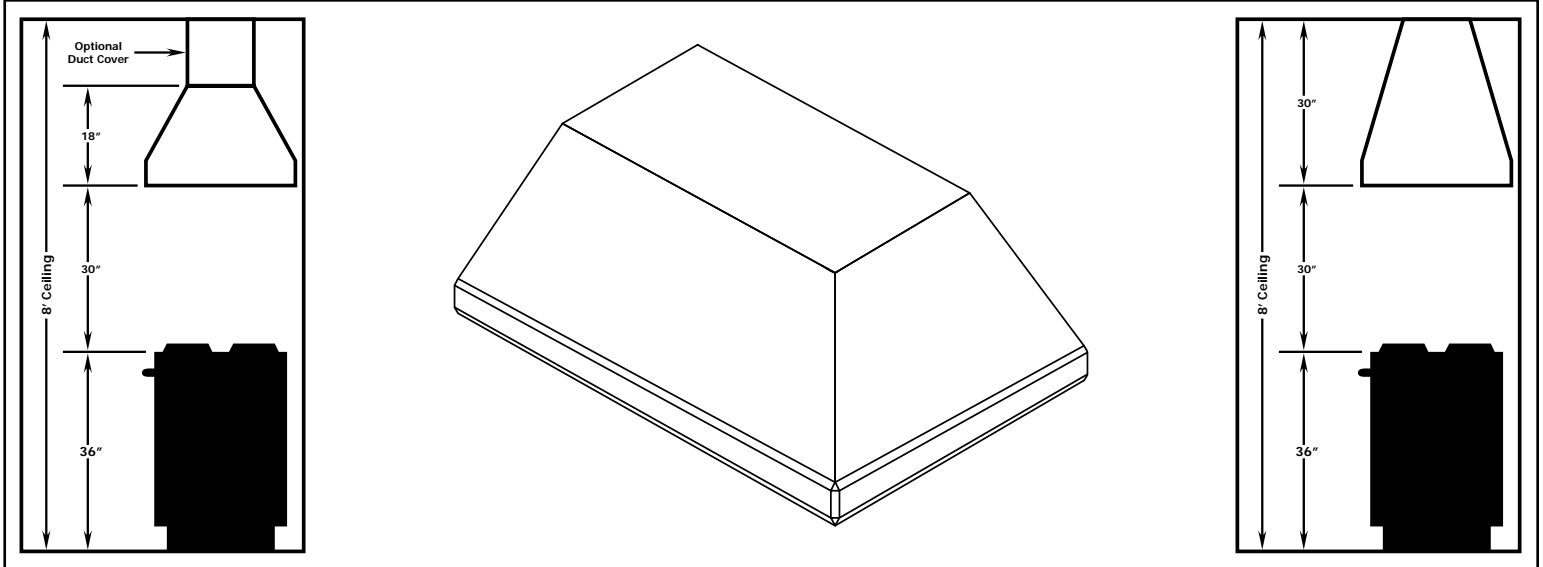

- 3) Load-bearing framework in the ceiling is necessary for installation. Additional framework construction may be required. Do not attach an island hood to a structure that cannot support twice the weight of the hood.

If applicable, remove the duct cover from its packaging and remove the hood-mounting screws from the base of the duct cover. Install the duct cover to the load-bearing framework in the ceiling using appropriate hardware through the four inside corner mounting flanges on the top of the duct cover.

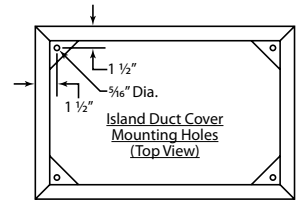

- 4) Install the duct(s) from the outside of the home down to the location of the exhaust outlet(s) on the top of the transition plus 1". This will allow the transition to engage 1" inside of the duct. Consult the connection diagrams (on next page) for further details on exhaust outlet placement.

Use duct tape to seal all joints. A complete listing of available Vent-A-Hood ducting materials is listed on the back page of this instruction sheet.

Transition height is as follows:

Island Dual Blower (T200): 8" round duct connects to 9" tall VP565 transition (included).

- 5) Prepare a protective surface on the floor or countertop for the hood. Remove the hood from its packaging and place it upside-down on the protective surface for access to the inside of the hood.
- 6) Remove the blower shields (A) by loosening the two brass screws on the bottom of the shield. Gently close the back draft dampers from the top side of the hood. To remove the blower housings, unsnap the suitcase latches (B) (one on each side of the housing). The housings should be pulled forward and gently "tipped" to clear the blower wheels and then out of the hood.

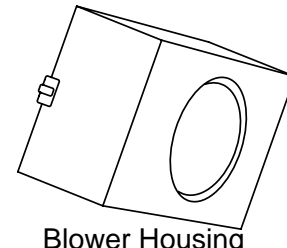
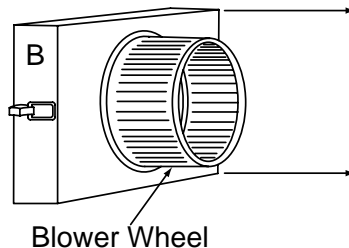
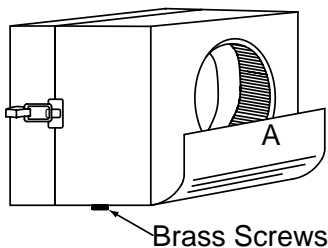

Vent-A-Hood®

Installation Details Continued

18" Tall Island Connection Diagram (36" - 54" Widths)

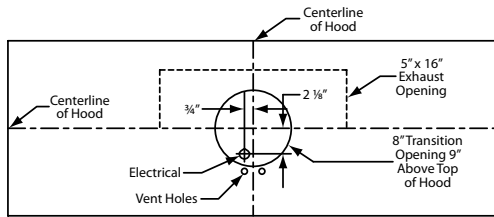

**550 CFM T200 Dual Blower
(Top View)**

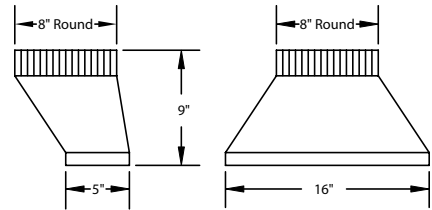

**VP565 Standard Transition
(Included)**

18" Tall Island Connection Diagram (60" - 66" Widths)

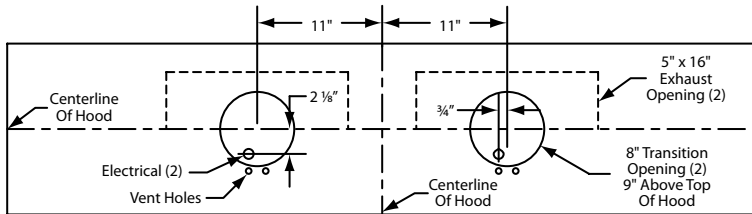

**1100 CFM T2+ 200 Dual Blowers
(Top View)**

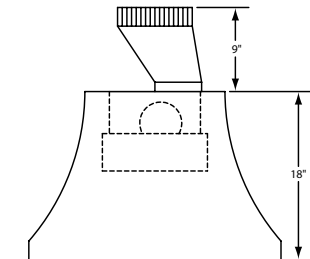

**Transition Installed
(Side View)**

30" Tall Island Connection Diagram (36" - 54" Widths)

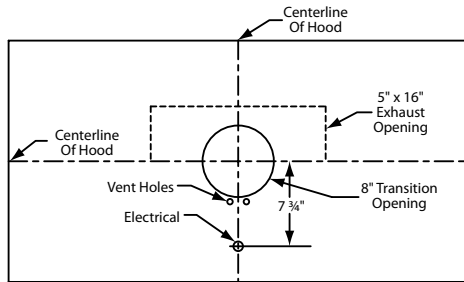

**550 CFM T200 Dual Blower
(Top View)**

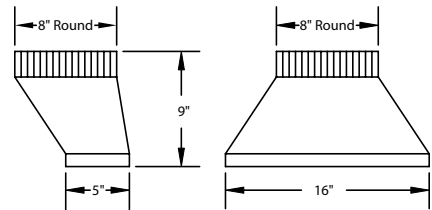

**VP565 Standard Transition
(Included)**

30" Tall Island Connection Diagram (60" - 66" Widths)

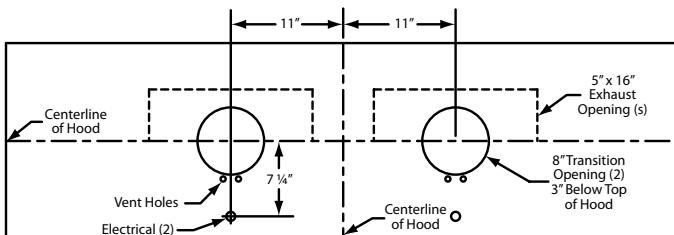

**1100 CFM T2+ 200 Dual Blowers
(Top View)**

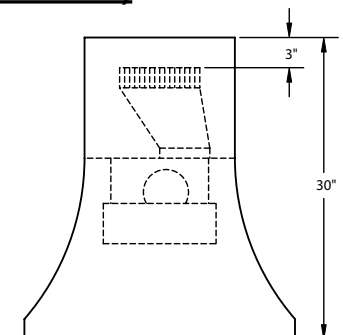

**Transition Installed
(Side View)**

Vent Hood®

Installation Details Continued

Warning: Make sure power is off and locked at the service disconnecting means on the service panel during installation.

- 7) FOR HOODS WITH REMOVABLE BLOWER MOUNTING ASSEMBLIES ONLY. IF HOOD DOES NOT HAVE A REMOVABLE BLOWER MOUNTING ASSEMBLY, PROCEED DIRECTLY TO STEP 9. Remove each blower deck assembly by removing the 12 screws around the blower mounting plate. Unplug the electrical connector and set the blower assembly aside, taking care not to damage blower wheels.
- 8) Install an appropriate 1/2" UL listed electrical wire clamp through the electrical strap(s) on the top of the hood deck. Install electrical wiring from the service panel to the hood location for each blower assembly. Consult the connection diagrams (previous page) for further details on electrical placement. Support the hood under the location where it will hang and feed the electrical wire(s) through the wire clamp(s). Tighten the clamp(s). **SKIP STEP 9. PROCEED DIRECTLY TO STEP 10.**

Model	Volts	Amps*	Hz	RPM	CFM SP@0.0"	Equivalent CFM*	CFM SP@0.1"	CFM SP@0.2"	CFM SP@0.3"	Minimum Round Duct Size	Sones [‡]
T200 Island Dual	115	2.9	60	1550	550	900	507	471	431	8" (50 in. ²)	6.0

* Add 0.5 amp for each halogen light.

• Because the Magic Lung™ blower uses centrifugal filtration rather than conventional baffle or mesh filters, the Magic Lung™ blower can handle cooking equipment with higher cubic feet per minute (CFM) requirements and can deliver equivalent CFM much more efficiently than other than other filtration systems. When comparing the Magic Lung™ with other blower units made by other manufacturers, use the "Equivalent CFM".

‡ Ratings in accordance with the Standard Test Code by the Energy Systems Laboratory of the Texas Engineering Experiment Station.

- 9) FOR HOODS WITH NON-REMOVABLE BLOWER MOUNTING ASSEMBLIES ONLY. IF HOOD HAS A REMOVABLE BLOWER MOUNTING ASSEMBLY, PROCEED DIRECTLY TO STEP 10. Remove the three screws retaining each blower motor. Unplug and remove the motors, taking care not to damage the blower wheels. It is not necessary to remove the blower wheels from the motors.

Attach the transition to each dual blower assembly and seal with duct tape. The transition must fit inside the exhaust collar on the blower assembly.

Install an appropriate 1/2" UL listed electrical wire clamp through each motor box electrical opening on top of the hood. Install electrical wiring from the service panel to the hood location for each motor box. Consult the connection diagrams (previous page) for further details on electrical placement. Feed the electrical wire(s) through the wire clamp(s). Tighten the clamp(s). **SKIP STEP 10. PROCEED DIRECTLY TO STEP 11.**

- 10) FOR HOODS WITH REMOVABLE BLOWER MOUNTING ASSEMBLIES ONLY. IF HOOD DOES NOT HAVE A REMOVABLE BLOWER MOUNTING ASSEMBLY, PROCEED DIRECTLY TO STEP 11. Raise the hood to its final position and attach it to the load-bearing framework in the ceiling using appropriate hardware or to the duct cover(s) using the screws previously removed in Step 3. From inside the hood, using UL listed wire nuts, attach the "neutral" wire(s) to the white lead(s), the "hot" wire(s) to the black lead(s), and the ground wire(s) to the green lead(s). **SKIP STEP 11 AND 12. PROCEED DIRECTLY TO STEP 13.**

Warning: Do not operate hood without proper ground connection.

- 11) FOR HOODS WITH NON-REMOVABLE BLOWER MOUNTING ASSEMBLIES ONLY. IF HOOD HAS A REMOVABLE BLOWER MOUNTING ASSEMBLY, PROCEED DIRECTLY TO STEP 12. While taking care to properly align the duct connection between the transition(s) and the duct(s) in the ceiling, raise the hood to its final position and attach it to the load-bearing framework in the ceiling using appropriate hardware or to the duct cover(s) using the screws previously removed in Step 3.



Installation Details Continued

- 12) From inside the hood, using UL listed wire nuts, attach the “neutral” wire(s) to the white lead(s), the “hot” wire(s) to the black lead(s), and the ground wire(s) to the green lead(s). Plug the motors into the hood and reinstall the blower motors using the three retaining screws that were previously removed in Step 9. Note: The side of the motor box where the “black” motors mount is labeled to ensure the motors are installed back into the hood in the proper position. **PROCEED DIRECTLY TO STEP 14.**

Warning: Do not operate hood without proper ground connection.

- 13) **FOR HOODS WITH REMOVABLE BLOWER MOUNTING ASSEMBLIES ONLY. IF HOOD DOES NOT HAVE A REMOVABLE BLOWER MOUNTING ASSEMBLY, PROCEED DIRECTLY TO STEP 14.** Attach the transition(s) to each deck blower assembly and seal with duct tape. The transition must fit inside the exhaust collar on the blower assembly. Reconnect the electrical connector for each blower deck assembly. For assemblies with two connectors, connect the right harness to the front connector and the left harness to the back connector. While taking care to properly align the duct connection between the transition and the duct in the ceiling, reinstall the blower deck assembly into the hood using the 12 screws previously removed in Step 7.
- 14) Replace the blower housings and the blower shields. Make sure that the dampers open and close smoothly.
- 15) Refer to Owner Maintenance Guide Operating Instructions for proper hood operation. Test all blower and light functions to ensure they are operating properly.

VENTING



ACCESSORIES

WALL LOUVER

MODEL	DIM
VP526	6" Round
VP527	7" Round
VP528	8" Round

WALL LOUVER

MODEL	DIM
VP554	10" Round

WALL LOUVER

MODEL	DIM
VP555	12" Round

RECTANGULAR WALL LOUVER

MODEL	DIM
VP538	6" x 8 1/2"
VP560	3 1/4" x 10"

LOW PROFILE ROOF JACK (MAXIMUM 4/12 PITCH)

MODEL	DIM
VP539	6" Round
VP540	7" Round
VP541	8" Round

LOW PROFILE ROOF JACK (MAXIMUM 4/12 PITCH)

MODEL	DIM
VP552	10" Round
VP553	12" Round

ADJUSTABLE ELBOW

VP513 - 8 1/2"
VP514 - 9 3/16"
VP515 - 10 3/8"

MODEL	DIM
VP513	6" Round
VP514	7" Round
VP515	8" Round

BACK/SIDE VENT ELBOW

MODEL	DIM
VP561	8" to 6" x 8 1/2"

3 1/4" x 10" BACK VENT ELBOW

MODEL	DIM
VP559	3 1/4" x 10"

MULTI-BLOWER TRANSITION

VP562 - 17 1/2"
VP563 - 16 1/2"
VP562 - 23 1/4"
VP563 - 30 1/2"

MODEL	DIM
VP562	6" & 8" to 10"
VP563	8" & 8" to 12"

"Y" TRANSITION

MODEL	DIM
VP517	8" & 8" to 12"
VP518	6" & 8" to 12"
VP551	6" & 8" to 10"

3 1/4" x 10" TO 7" TRANSITION

MODEL	DIM
VP521	3 1/4" x 10" to 7"

OFFSET KIT - ROUND

MODEL	DIM
VP529	6" Rnd to 7" Rnd

OFFSET KIT - RECTANGULAR

MODEL	DIM
VP550	6" Rnd to 3 1/4" x 10"

STANDARD ISLAND TRANSITION

MODEL	DIM
VP565	5" x 16" to 8"

CLUSTER BLOWER TRANSITION

MODEL	DIM
VP564	8" & 8" to 12"

OFFSET L & R TRANSITION FOR ISLAND BLOWERS

MODEL	DIM
VP542	Top Left
VP543	Top Right

SIDE VENT TRANSITION L & R FOR ISLAND BLOWERS

MODEL	DIM
VP544	Left Side
VP545	Right Side

6" & 8" COLLAR

MODEL	DIM
VP533	6" Round
VP535	8" Round

6" x 8 1/2" COLLAR

MODEL	DIM
VP537	6" x 8 1/2"

ROUND DUCT PIPE

MODEL	DIM
VP500	6" Round
VP501	7" Round
VP502	8" Round

3 1/4" RECTANGULAR DUCT PIPE

MODEL	DIM
VP504	3 1/4" x 10"
VP505	3 1/4" x 12"
VP506	3 1/4" x 16"

6" RECTANGULAR DUCT PIPE

MODEL	DIM
VP507	6" x 8 1/2"