

Koldfront[®]

Window Air Conditioner

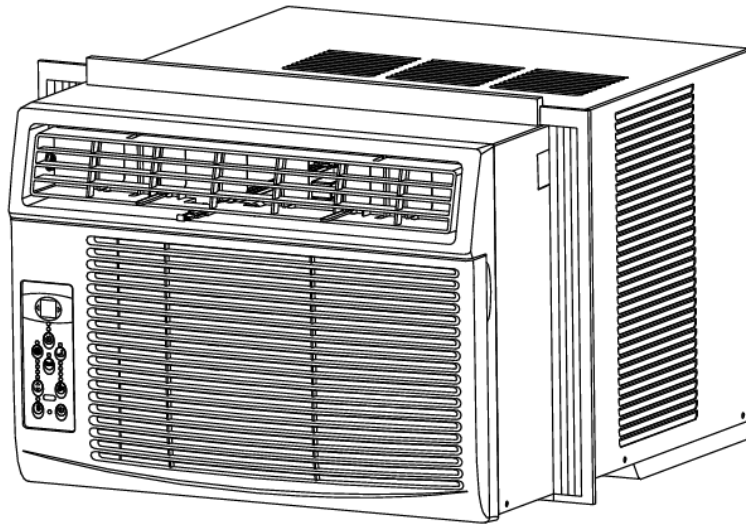

WAC8002WCO

Owner's Manual

For more information on other great EdgeStar products on the web, go to <http://www.edgestar.com>

Important Safety Information

Improper handling can cause serious damage to the appliance and/or to the user. Please read the following safety information.



Warning: The water produced by the window AC is not potable or suitable for drinking.

Do not drink the water drained from the unit as it contains contaminants and could make you sick.



Electrical Safety

- Make sure your hands are dry and not wet before operating the unit.
- Do not wet the front housing or control panel.
- Do not directly spray water on this Air Conditioner.
- Do not pull the unit by the cord.
- Always turn the unit off and unplug it from the socket when cleaning.
- Unplug the unit if it is not going to be used for a long period of time.
- Do not operate the unit with a damaged or loose plug and/or socket.
- Use only the correct power supply with appropriate amperage.
- If the power cord is damaged, it must be replaced by the manufacturer, a service agent, or qualified technician.
- Do not turn the unit off or on by inserting or pulling the power plug.
- Do not modify the power cord length or share the outlet with another appliance.
- Do not use this unit with an extension cord and/or adapter plug.
- Do not use this unit near flammable gases/combustibles or close proximity to heating appliances.
- During operation, do not remove any part of the outside casing.



General Safety

- Do not let people or pets sit or set an object directly in front of air flow.
- If a strange sound, smell, or smoke comes from the unit, turn it off and review the troubleshooting page of this manual.
- Stop operation and unplug unit in the event of a severe storm.
- To ensure proper air flow and intake, make sure the air vents are not obstructed.
- See instructions for cleaning air filters and how often cleaning should occur.
- Do not use strong detergents when cleaning.
- Children should be supervised when operating this unit.
- Do not allow children to play with the controls or drop any objects into the air outlets or vents.
- Do not place objects or let any person sit on top of the unit.
- Route the power cord carefully to avoid a tripping hazard.
- This unit is intended for domestic home use only. Do not use the window air conditioner for commercial or industrial use. Any other use may invalidate the warranty.
- Use caution when unpacking and installing the unit as there may be some sharp edges.

Operation of Safety Plug

Your cool-only window air conditioner is supplied with a Leakage-Current Detection and Interruption (LCDI) safety plug. This device provides protection to reduce the risk of fire due to arcing faults in the power supply cord. Before using your window air conditioner, follow the instructions below to ensure that the LCDI plug is working properly:

1. Plug the power cord to a grounded outlet.
2. Press the TEST button on the LCDI plug. This should trip the plug and cut the power to the air conditioner. If the plug does not trip and you are able to turn on the unit, please contact EdgeStar support.

DO NOT USE YOUR COOL-ONLY WINDOW AIR CONDITIONER IF THE TEST FAILS.

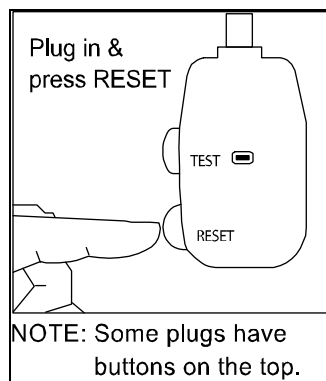

3. Press the RESET button to start using your air conditioner.

NOTES:

- Always make sure the “Reset” button is pushed in for proper operation.
- The power supply cord with LCDI plug must be replaced if it fails to reset.
- Do not use the TEST and RESET buttons as an ON/OFF switch.

Electrical products should not be disposed of with household waste. Please contact your local recycling center for more information on how to recycle electronic waste.



Table of Contents

IMPORTANT SAFETY INFORMATION	I
OPERATION OF SAFETY PLUG	II
TABLE OF CONTENTS	III
INTRODUCTION	1
PARTS IDENTIFICATION	2
FRONT / SIDE VIEW	2
PREPARATIONS FOR INSTALLATION	3
PARTS SUPPLIED:	3
WINDOW INSTALLATION INSTRUCTIONS	4
PREPARING THE UNIT FOR WINDOW INSTALLATION	4
INSTALLING UNIT INTO WINDOW	6
SEAL AIR GAPS	8
COMPLETING INSTALLATION.....	9
CONTROL PANEL OPERATIONS	10
USING THE CONTROL PANEL	10
<i>To Turn Unit on:</i>	10
<i>To Change Temperature:</i>	10
<i>To Adjust Fan Speeds:</i>	10
<i>To Select Operating Mode:</i>	10
<i>To Operate in Auto Mode:</i>	11
<i>To Operate in Fan Only:</i>	11
<i>To Operate in Dry mode:</i>	11
<i>To Use Energy Saver Feature:</i>	11
<i>To Use the Sleep Feature:</i>	11
<i>To Use Timer (Auto Start/Stop) Feature:</i>	11
<i>Check Filter Feature:</i>	12
<i>Digital Display:</i>	12
<i>Additional Tips:</i>	12
USING THE REMOTE CONTROL	13
MAINTENANCE	14
AIR FILTER CLEANING	14
CABINET CLEANING.....	14
NORMAL SOUNDS	15
<i>Error Codes</i>	15
ENERGY SAVING GUIDE	15
TROUBLESHOOTING	16
SPECIFICATIONS	18
EDGE STAR LIMITED WARRANTY	19

Introduction

Thank you for purchasing this Koldfront *by EdgeStar* cool-only window air conditioner. We are glad you chose us. We believe that your purchase of this product opens a relationship between you and EdgeStar. We will provide the customer support needed to nurture that relationship.

This manual contains important information regarding the proper installation, use and maintenance of your window air conditioner. Following this manual will ensure that your product will work at its peak performance and efficiency.

Please save the original product packaging in case you need to safely transport your window air conditioner.

For Your Records:

Please write down the model number and serial number below for future reference. Both numbers are located on the ratings label on the back of your unit and are needed to obtain warranty service. You may also want to staple your receipt to this manual as it is the proof of your purchase, and is also needed for service under your warranty.

Model Number: _____

Serial Number: _____

Date of Purchase: _____

To better serve you, please do the following before contacting customer service:

- If you received a damaged product, immediately contact the dealer that sold you the product.
- Read and follow this instruction manual carefully to help you install, use and maintain your window air conditioner.
- Read the troubleshooting section of this manual as it will help you diagnose and solve common issues.
- Visit us on the web at <http://www.edgestar.com> for product guides, additional troubleshooting resources and up-to-date information. If you need service, our friendly customer service representatives are available via email at service@edgestar.com or by telephone at **1 (866) 319-5473**.

Parts Identification

Front / Side View

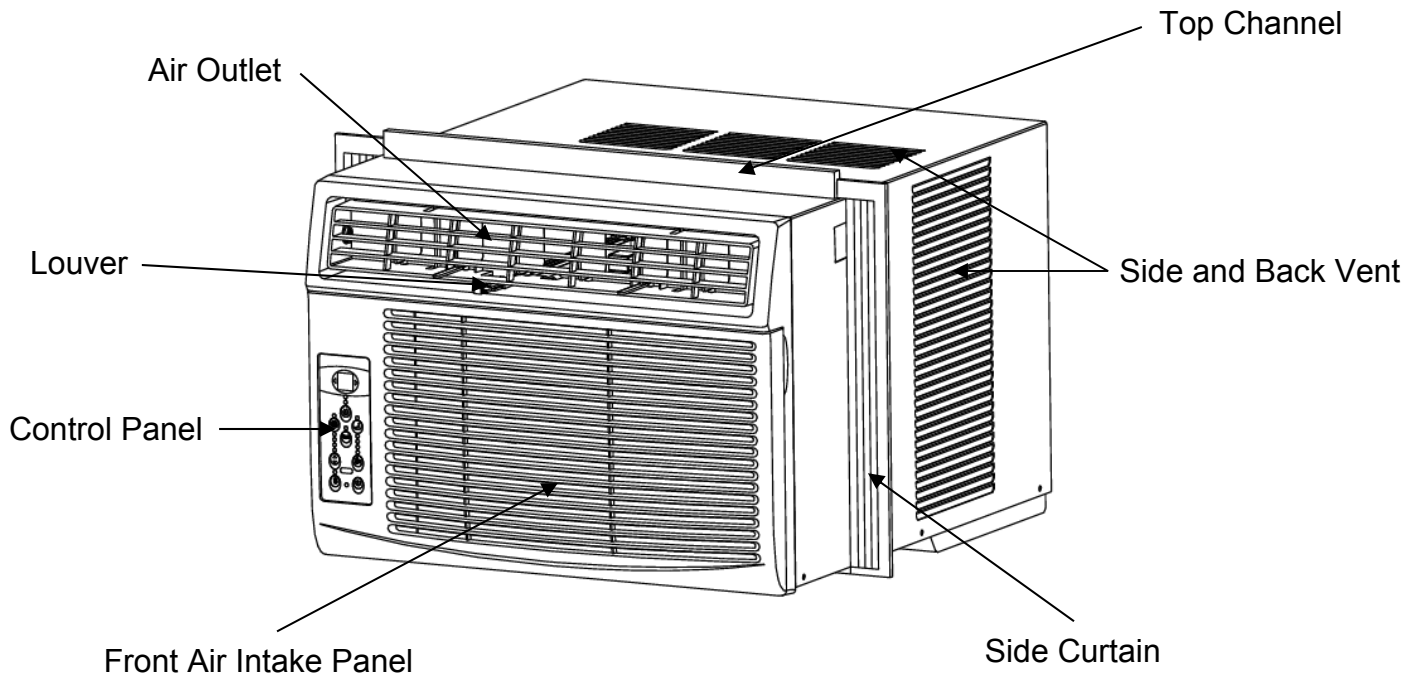

Preparations for Installation

Tools Needed:

Phillips Screwdriver
Tape Measure
Level
Drill
1/8" Drill Bit

NOTE: To avoid risk of injury and/or product/property damage, please take the following precautions:

- Two or more people are needed to properly handle and install.
- Use proper lifting and carrying techniques.
- Before installation, make sure to inspect that the window and sill are able to handle the weight and size of this unit.
- Wearing protective gloves will help to avoid injury from sharp edges.

Before you begin, make sure you have all the tools and parts necessary for installation.

Parts Supplied:

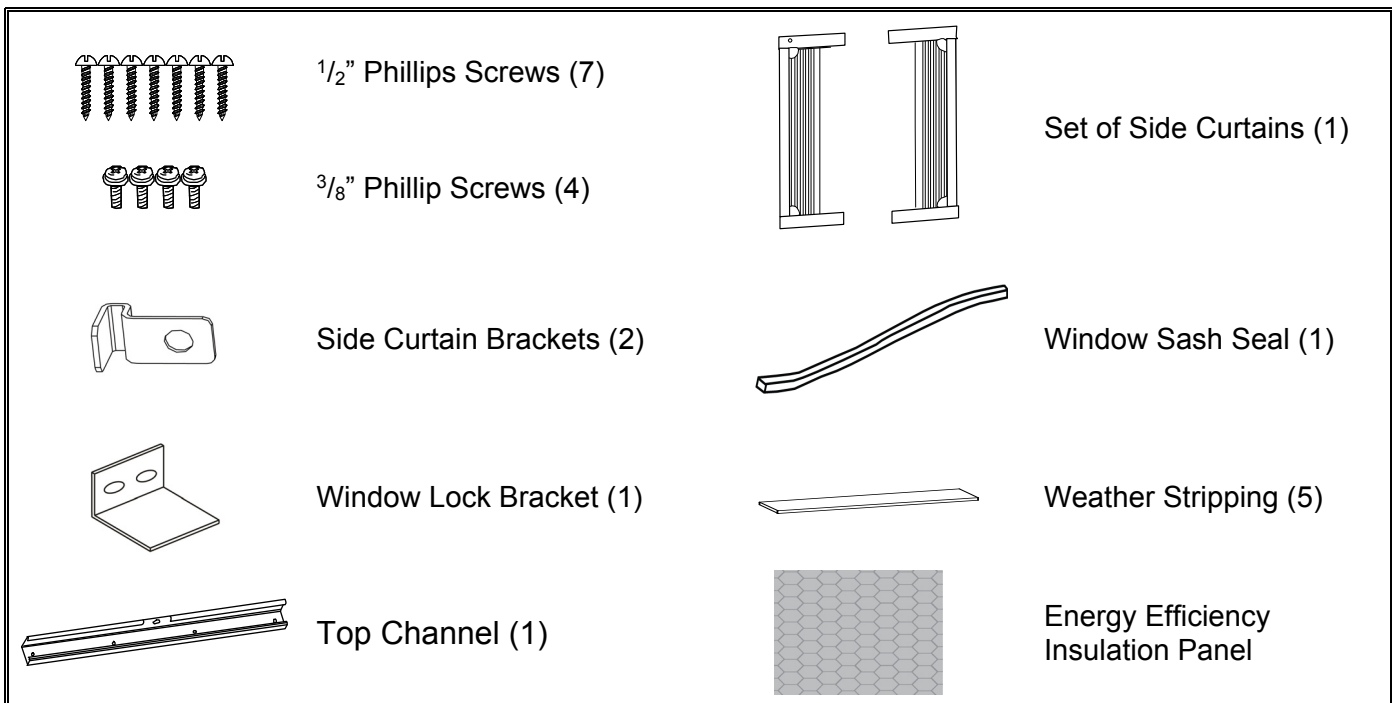

NOTE: You may need to contact your electrician if your room's circuit is not able to power your unit.

If you have multiple windows, choose one that is near an electrical outlet that will be able to provide sufficient power to your unit. See the power requirements listed on the product label printed on the side, or on the back of your window air conditioner.

The following measurements are required to properly install the air conditioner.

- Window Width: 23" to 36"
- Window Minimum Height: 14"

NOTE: When choosing your window make sure the power supply cord is within 4 feet of a grounded 3-prong outlet.

Window Installation Instructions

Please follow all installation instructions to avoid personal injury or damage. It is important that all you save all original packaging materials in case you need to safely transport your window air conditioner. Packaging materials must be stored away from children and in a safe manner.

NOTE: The unit must be installed firmly and securely to prevent excessive noise and vibration.

Preparing the Unit for Window Installation

Attaching the Top Channel and Side curtains

Make sure to attach the top channel and side curtains prior to installing the cabinet into the window.

1. Set the air conditioner unit on a table or other solid work surface.
2. Place the top channel on top of the air conditioner cabinet, lining up the four (4) holes in the top channel with the four (4) holes on top of the cabinet.
3. Use four (4) $\frac{3}{8}$ " Phillips screws to attach the top channel to the top of the cabinet.

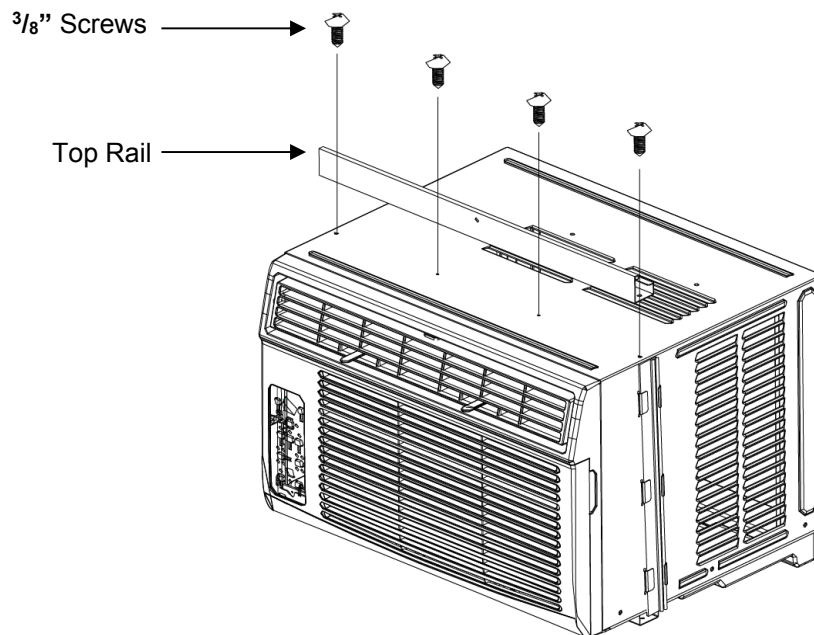

4. To attach the side curtains to the air conditioner, start by gently extending the accordion panel until you can insert the open end into the connector tabs located on the side of the unit.

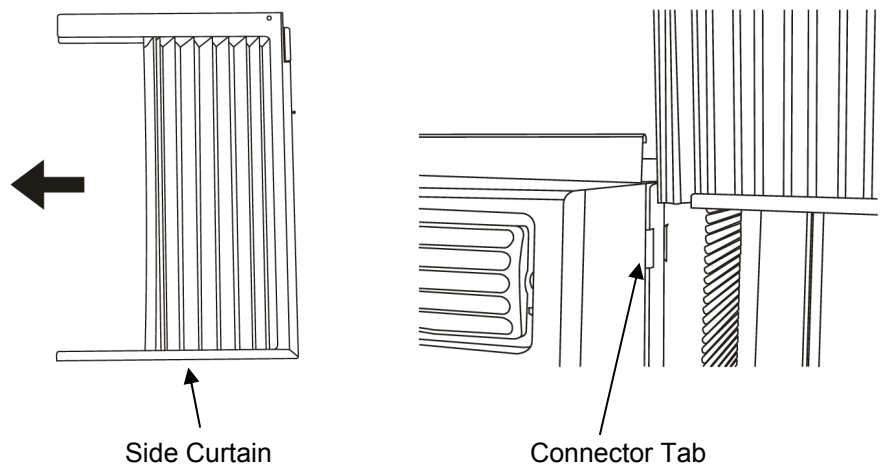

5. Insert the top and bottom of the curtain housing to the top curtain and bottom curtain channel.

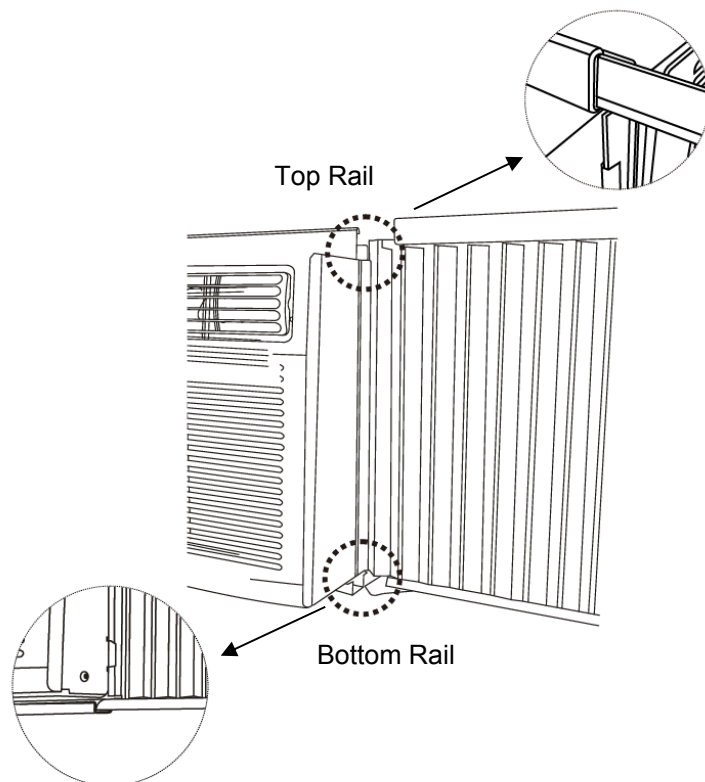

Installing Unit into Window

Follow the steps listed below to install the air conditioner into the window.

NOTE: When choosing your window make sure the power supply cord is within 4 feet of a grounded 3-prong outlet.

1. Center the air conditioner cabinet into window:
 - Check that the lower rail of the air conditioner cabinet is behind and against the back side of the window sill.
 - Maintain a firm hold on the cabinet and lower the window sash to hold the cabinet in place.
 - Measure the distance of the right side and left, and adjust until the unit is perfectly centered.

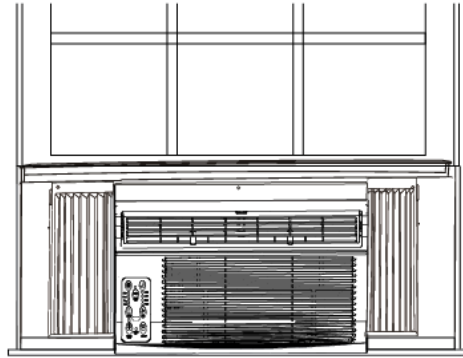

NOTE: Check that the air conditioner cabinet is tilted back about $1 \frac{1}{8}$ " to $1 \frac{1}{2}$ ", which should be about 3-4 degrees downward to the outside. After proper installation, condensation should not drain from the overflow drain hole during normal use, correct slope or otherwise.

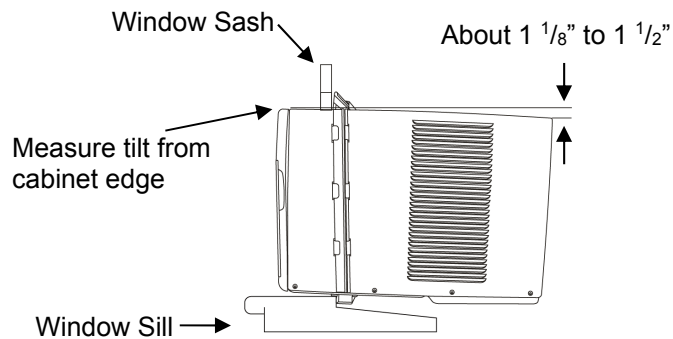

2. Extend both Side Curtains outward until they are flush with the window frame

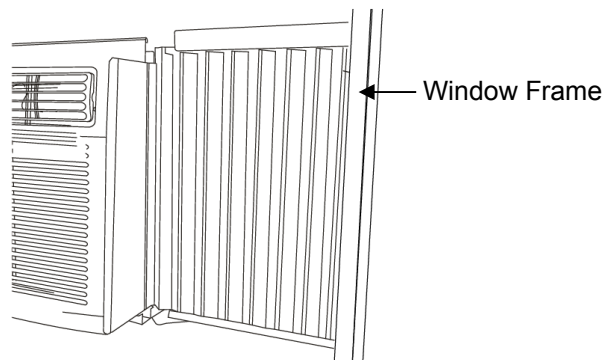

3. Attach Curtain Brackets

- The Curtain Brackets will secure the lower frame of the side curtains to the window sill.
- Place the Curtain Bracket in between the accordion extensions as shown in the image below.
- Use one (1) 1/2" Phillips head screw to attach the Curtain Brackets to the window sill.
- Repeat procedure for remaining side curtain.

NOTE: Use a 1/8" drill bit to drill pilot holes in window sill to prevent splitting before driving screws into place.

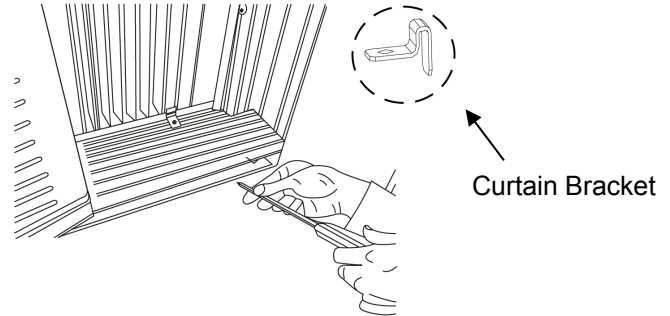

4. Attach Side Curtains to Window Frame

- Use three (3) 1/2" Philips head screws to attach the side curtain frame and top channel to the window sash.

NOTE: Use a 1/8" drill bit to drill pilot holes in window sill to prevent splitting before driving screws into place.

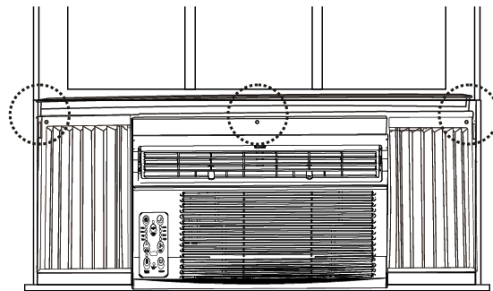

5. Attach Window Lock Bracket

- Secure lower window sash to the upper window sash with the Window Lock Bracket.
- Use two (2) 1/2" Phillips head screws to attach the bracket to the upper window sash.
- Once installed, the bracket will prevent the lower window sash from being raised upwards.

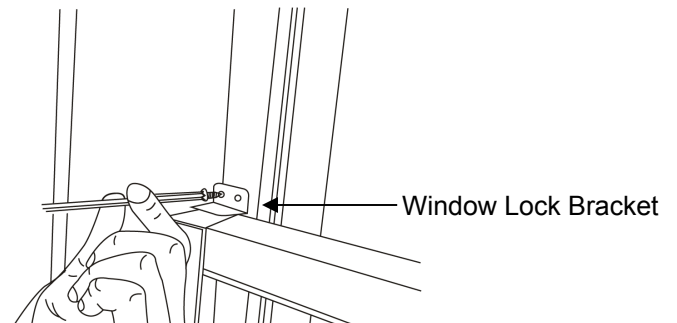

Seal Air Gaps

1. Install Window Sash Seal

- Trim the window sash seal (foam) to the appropriate length and insert into the gap that is between the upper and lower window sashes.

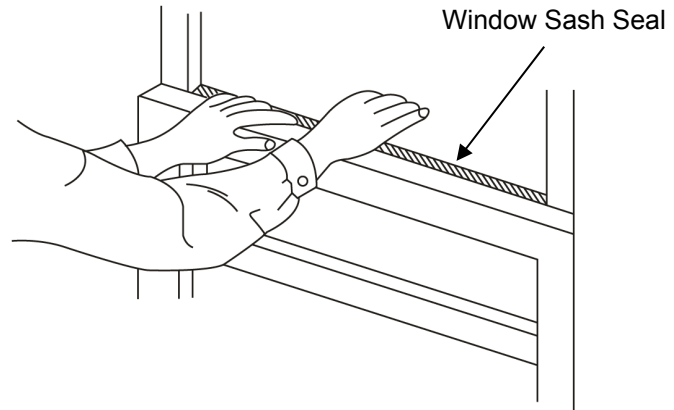

2. Install Energy Efficiency Insulation Panels

- This unit comes with insulating sheets that should be installed into each of the side curtains to maximize energy efficiency.
- Start by measuring the inner width of both side curtains.

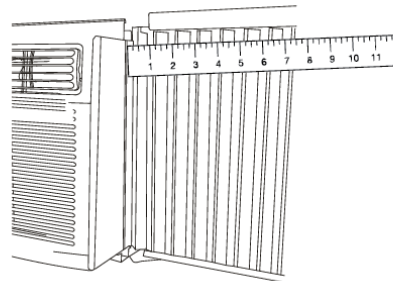

- Locate the insulation panel supplied with this unit and cut each panel to the correct width.
- Slide the insulation panels into each side curtain as shown below with the pattern side facing inward (indoors).

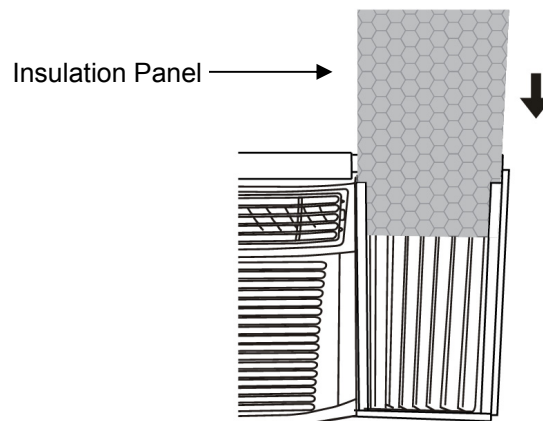

3. Attach weather stripping

- In order to minimize air leaks, this unit comes with weather stripping that should be installed as needed to plug any gaps that may be present after you have secured the air conditioner into the window.
- Inspect all of the potential air gaps around the window opening.
- Cut to size and attach weather stripping as needed.

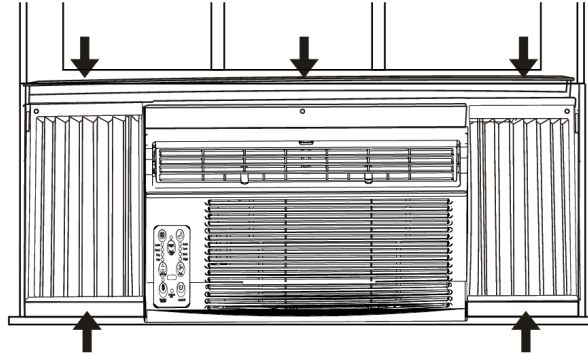

Completing Installation

Now that you have completed the installation steps, your window air conditioner is ready for use.

- Plug the power cord into a properly grounded 3-prong outlet.
- Press “Reset” on the LCDI plug.
- Read Control Panel Operations section for instructions on all modes and settings for your air conditioner unit.

Control Panel Operations

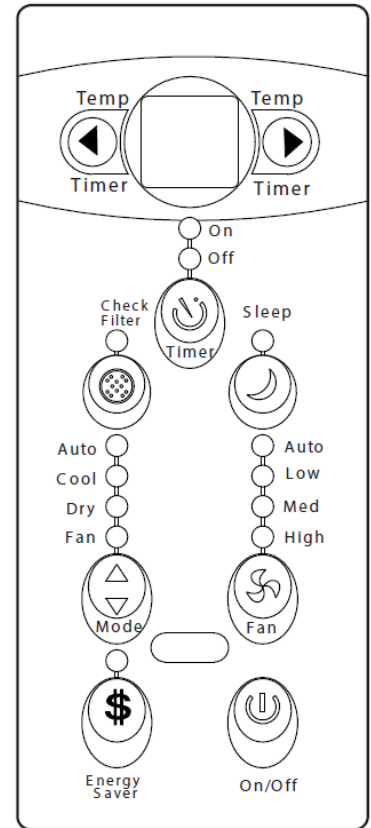
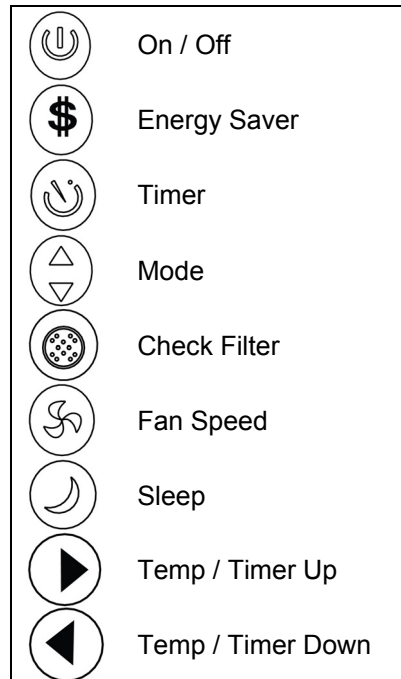

Using the Control Panel

To Turn Unit on:

Press On/Off Button. NOTE: the Energy Saver feature will automatically turn on in "Cool", "Dry", and "Auto" modes.

To Change Temperature:

Press or hold either Up or Down button until desired temperature is seen on the digital display. This temperature will be automatically maintained anywhere between 62 °F (17°C) and 86°F (30°C). If you want the display to read the actual room temperature, see "To Operate in Fan Only" section.

To Adjust Fan Speeds:

To select the speed of the fan, press Fan Speed in four steps: Auto, Low, Medium, or High. Each time the button is pressed the fan speed progresses to the next speed option. NOTE: in "Dry" mode the fan speed is set at Low automatically.

To Select Operating Mode:

To choose operating mode, press Mode . Each time you press the button, a mode is selected in a sequence that goes from Auto, Cool, Dry to Fan. The indicator light adjacent to the mode label will be illuminated and remain on once the mode is selected.

To Operate in Auto Mode:

- When you set the unit to “Auto” mode it will automatically select cooling or fan only operation depending on the temperature selected and the current room temperature.
- Once the temperature you selected is achieved, the unit will automatically maintain the room temperature.
- In this mode the fan speed cannot be adjusted. It will start automatically at a speed according to the actual room temperature.

To Operate in Fan Only:

- Use this function only when cooling is not desired, such as for room circulation or to exhaust air (remember to open the vent). You can choose any speed you prefer.
- In this mode, the display will show the actual room temperature as in the cooling mode.
- In Fan Only mode, the temperature is not adjusted.

To Operate in Dry Mode:

- In this mode, the air conditioner will operate as a dehumidifier. Because the conditioned space is closed or sealed, some degree of cooling will continue to occur.





To Use Energy Saver Feature:

To start the Energy Saver mode, press . This option is available on “Cool”, “Dry”, and “Auto”. The fan will continue to run for 3 minutes after the compressor shuts off. The fan then cycles on for 2 minutes at 10 minute intervals until the room temperature is above the set temperature at which time the compressor turns back on and cooling starts.

To Use the Sleep Feature:

To initiate, press the Sleep button . In this mode the selected temperature will increase by 2°F (1°C) 30 minutes after the mode is selected. The temperature will then increase by another 2°F (1°C) after an additional 30 minutes. This new temperature will be maintained for six (6) hours before it returns to the originally selected temperature. This ends the Sleep mode and the unit will continue to operate as originally programmed. The Sleep Mode program can be cancelled at any time during operation by again pressing the Sleep button.

To Use Timer (Auto Start/Stop) Feature:

- When the unit is on or off, press the Timer button  and the “Timer On” indicator light illuminates. It indicates the Auto Start program is initiated.
- To turn the timer off, press the Timer button  again and the “Timer Off” indicator light illuminates. It indicates the Auto Stop program is initiated.
- Press or hold the Up  or Down  to change the Auto Time by ½ hour increments up to 10 hours; 1 hour increments thereafter up to 24 hours. The control will count down the time remaining until start.

- The selected time will register in five (5) seconds and the system will automatically revert back to display the previous temperature setting or room temperature when the unit is on. (NOTE: when the unit is off there is no display.)

Check Filter Feature:

This feature is a reminder to clean the Air Filter for more efficient operation. The LED light will illuminate after 250 hours of operation. To reset the check filter timer and to turn off the Check Filter indicator, simply clean the filter as indicated in the maintenance section of this manual and press Check Filter button .

Digital Display:

Displays the set temperature in °C or °F and the Auto Timer settings. While in Fan Only mode it shows the room temperature.

Air Directional Louvers:

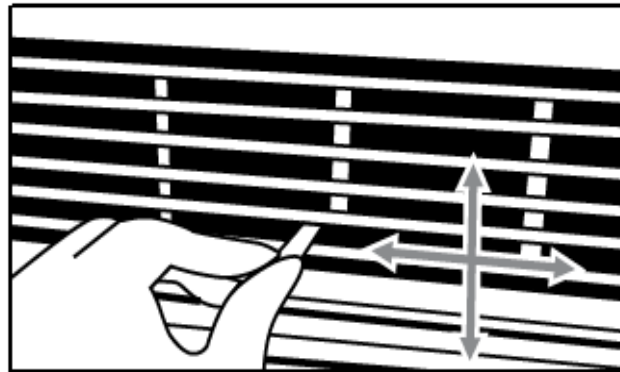

The 4-way air directional louvers allow you to direct the air flow Up, Down, Left, and Right throughout the room as needed. To adjust the air directional louvers side-to-side use the center handles as you move side to side.

Additional Tips:

The “Cool” mode has an automatic three (3) minute timed delay start if the unit is turned off and on quickly. This prevents overheating of the compressor and possible circuit breaker tripping. The fan will continue to run during this time.

The control panel is capable of displaying the temperature in degrees Fahrenheit or degrees Celsius. To convert from one to the other, press and hold the Up and Down Temp/Timer buttons at the same time for three (3) seconds.

Using the Remote Control

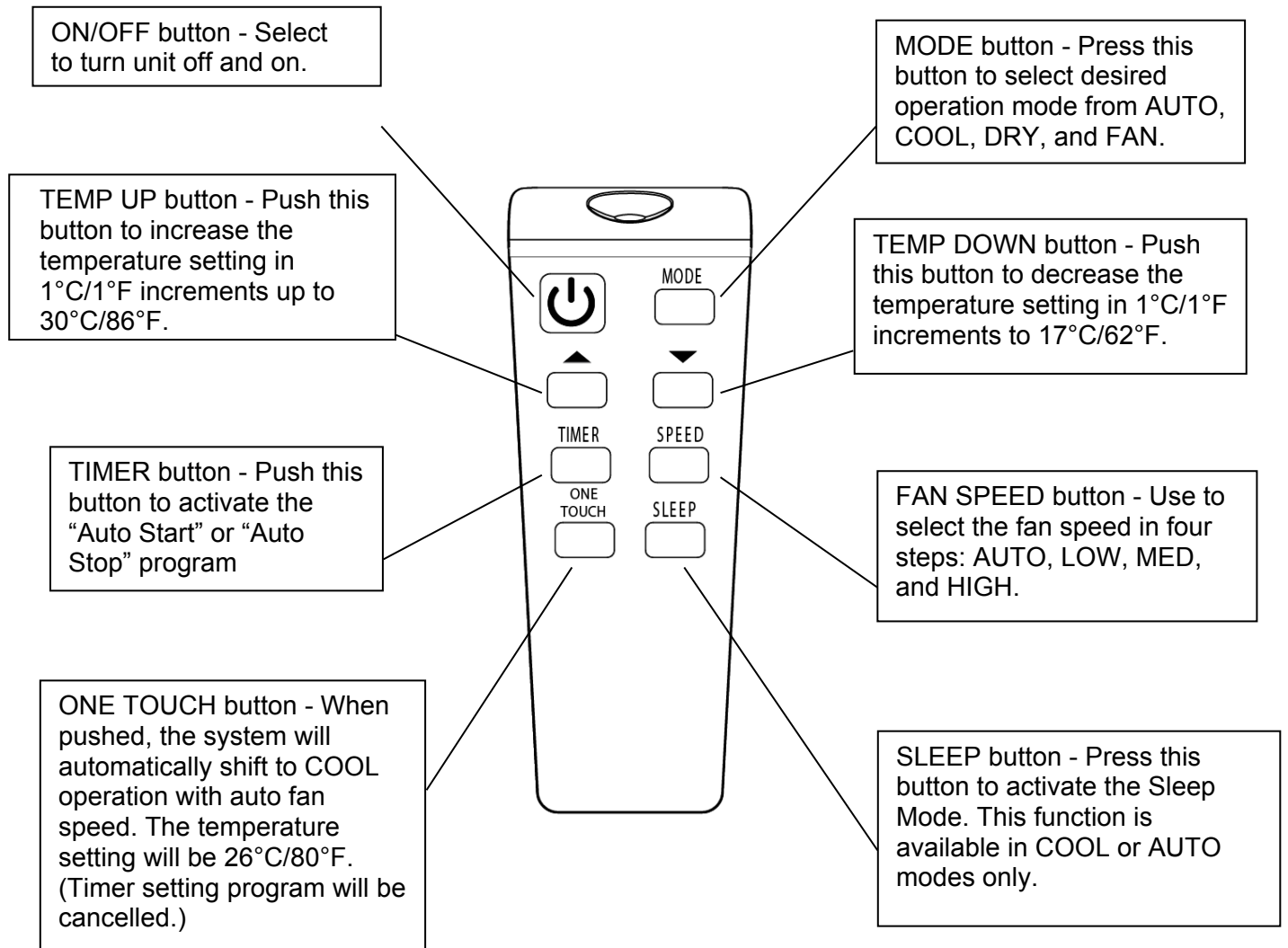

Additional Notes on Remote Control Operation:

- The remote control has an operating range of 16 ft from the appliance.
- The remote signal receiver/sensor is located on the control panel of the air conditioner.
- Reception of signal commands is confirmed by an audible beep.
- Direct sunlight can interfere with the infrared signal.
- To replace batteries, remove the back cover by pressing where indicated and sliding off the battery cover.

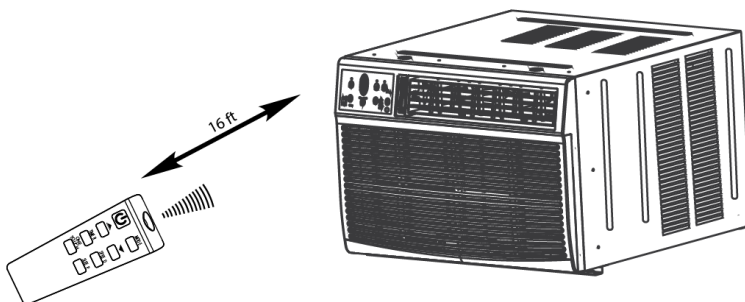

Maintenance

Clean the air conditioner and filter regularly to maximize performance and efficiency, and prolong the unit's life. Be sure to always unplug the air conditioner from the power outlet before cleaning.

Air Filter Cleaning

NOTE: Winter Storage- If you plan to store the air conditioner during the winter, remove it carefully from the window according to the installation instructions. Make sure to clean the unit thoroughly and cover it with plastic or return it to the original carton.

The air filter should be checked at least once a month to see if cleaning is necessary. Trapped particles in the filter can build up and could cause an accumulation of frost on the cooling coils. After 250 hours of operation, the Check Filter indicator will light up on the control panel as a reminder.

1. Push the vent handle to the "vent closed" position.
2. Open the front panel.
3. Grasp the filter at the center; pull up and out.
4. Wash the filter using liquid dishwashing detergent and warm water. Rinse filter thoroughly.
5. Gently shake excess water from the filter. Be sure the filter is thoroughly dry before replacing.
6. You may also gently clean the filter with a vacuum.
7. Re-install filter when thoroughly dry.
8. Press the Check Filter button on the Control Panel to reset the Check Filter timer.

Warning: never use hot water over 40°C (104°F) to clean the air filter. Never attempt to operate the unit without the air filter.

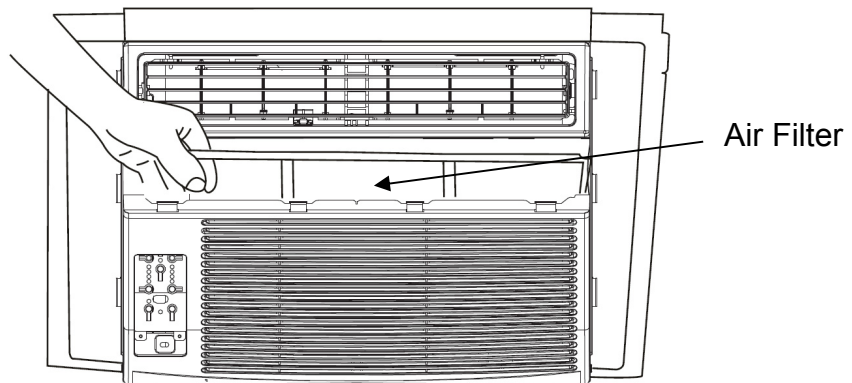

Cabinet Cleaning

- Be sure to unplug the air conditioner to prevent shock or fire hazard. The cabinet and front may be dusted with an oil-free cloth or washed with a cloth dampened in a solution of warm water and mild dishwashing detergent. Rinse thoroughly and wipe dry.
- Never use harsh cleaners, wax, or polish on the cabinet front.
- Be sure to wring excess water from the cloth before wiping around the controls. Excess water in or around the controls may cause damage to the air conditioner.

Normal Sounds

- High Pitched Chatter: high-efficiency compressors may have a high pitched chatter during the cooling cycle.
- Sound of Rushing Air: at the front of the unit, you may hear the sound of rushing air being moved by the fan.
- Gurgle/Hiss: gurgling or hissing noise may be heard due to refrigerant passing through evaporator during normal operation.
- Vibration: unit may vibrate and make noise because of poor wall or window construction or incorrect installation.
- Pinging or Switching: droplets of water hitting condenser during normal operation may cause these sounds.

Error Codes

AS - Room temperature sensor error

- ✓ Unplug the unit and plug back in.
- ✓ If error repeats call for service.
- ✓ NOTE- In Fan only mode it will display "LO" or "HI".

● - Evaporator temperature sensor error

- ✓ Unplug the unit and plug back in.
- ✓ If error repeats, call for service.

Energy Saving Guide

Read and follow the guide below to get the best performance and efficiency from your window air conditioner:

- Do not cover the air outlet (exhaust) while in use.
- Use the timer to operate the unit before it is needed. For example, set the timer to turn on the unit in cooling mode for three (3) or more hours to cool the room before you arrive. You may want to operate the unit all day if you live in a warmer climate.
- Minimize the heat sources (direct sunlight, computers, servers, people, etc.) in the room.
- Close all windows and doors.
- Use the unit in a contained room. For example, a room with four walls and a ceiling, instead of a partitioned studio or warehouse.
- Make sure the unit is secure with no gaps where air can escape.
- Minimize the amount of humidity in the room. Run the unit as a dehumidifier when necessary.
- To prolong the compressor's life, please wait at least three (3) minutes before turning the unit back on after shutting it off.
- Inspect and keep the air filters clean by cleaning regularly.
- Perform routine maintenance.

Troubleshooting

Follow the troubleshooting guide below to resolve common issues.

Issue	Possible Cause	Solution
My air conditioner is not functioning at all	Wall plug disconnected	Make sure the unit is plugged in
	LCDI power cord is tripped	Press the Reset button on the LCDI cord
	House fuse blown or circuit breaker tripped.	Replace fuse with time delay type or reset circuit breaker
	Control panel is off	Turn control panel ON and set to desired setting
	Insufficient power	Move the unit to another outlet. Check your circuit breaker. (Refer to the rating label on the back of the unit to determine the Amperage draw)
Air from unit does not feel cold enough	Room temperature below 17°C (62°F)	Cooling may not occur until room temperature rises above 17°C (62°F)
	Compressor shut-off by changing modes	Wait approximately 3 minutes and listen for compressor to restart when set in the COOL mode
Air conditioner is cooling but room is too warm, ice is forming on cooling coil behind decorative front	Outdoor temperature below 18°C (64°F)	To defrost the coil, set FAN ONLY mode
	Air filter may be dirty	Clean Filter. Refer to maintenance section. To defrost, set to FAN ONLY mode
	Unit needs to be defrosted	To defrost the coil, set to FAN ONLY mode. Then, set temperature to higher setting
Air conditioner is cooling but room is too warm, NO ice is forming on cooling coil behind decorative front	Dirty air filter, air restricted	Clean air filter. Refer to maintenance section
	Temperature is set too High	Set temperature to lower setting
	Air directional louvers positioned improperly	Position louvers for better air distribution
	Front of unit is blocked by drapes, blinds, furniture, etc., restricts air distribution	Clear blockage in front of unit

Issue	Possible Cause	Solution
Air conditioner is cooling but room is too warm. NO ice is forming on cooling coil behind decorative front	Open doors, windows, etc.	Open = cold air escapes. Close doors, windows, etc.
	Unit recently turned on in hot room	Allow additional time to remove "stored heat" from walls, ceiling, floor and furniture
Air conditioner turns on and off rapidly	Dirty air filter, air restricted	Clean air filter
	Outside temperature extremely hot	Set FAN speed to a higher setting to bring air past cooling coils more frequently
Noise when unit is cooling	Air movement sound - this is normal	If too loud, set to a slower FAN setting
	Window vibration or poor installation	Refer to installation instructions or check with installer
Water dripping INSIDE when unit is cooling	Improper installation	Tilt air conditioner slightly to the outside to allow water drainage
Water dripping OUTSIDE when unit is cooling	Unit removing large quantity of moisture from humid room	This is normal during excessively humid days
Remote not sensing	Remote control not located within range	Use remote control within 16 feet and 180 degree radius of the front of the unit
	Remote control signal obstructed	Remove obstruction
Room too cold	Set temperature too low	Increase set temperature

Specifications

Description of product	Window Air Conditioner
Model	WAC8002WCO
Voltage/Frequency	115V / 60Hz
Plug Type	LCDI
Power Cord Length	6.5 ft
BTUs (cooling)	8000
Current (cooling)	5.9A
Rated CEER	12.0
Color	White
Coolant	R410A
Timer	24 Hour
Dimensions (inches) W x D x H	18 1/2 x 17 1/2 x 13 1/3
Net Weight	51 lbs

EdgeStar Limited Warranty

One (1) Year Parts & Ninety (90) Days Labor

This product is warranted by EdgeStar to be free from defective workmanship and materials, subject to any conditions set forth as follows:

WHAT IS COVERED:

LABOR: For a period of NINETY (90) DAYS from the date of original purchase, labor will be performed free of charge at an authorized EdgeStar repair facility. At its option, EdgeStar will repair the product with new or remanufactured parts, or exchange the defective product with a new, refurbished, or remanufactured product. If a product is replaced, it will carry the remaining warranty of the original product. After the ninety (90) day period, EdgeStar will no longer be responsible for labor charges incurred. All defective products and parts covered by this warranty will be repaired or replaced on a mail-in basis to an EdgeStar authorized repair facility.

PARTS: For a period of ONE (1) YEAR from the date of original purchase, EdgeStar will supply new, rebuilt, or refurbished parts free of charge. EdgeStar may request a defective part be returned in exchange for the replacement part. All replacement parts or products will be new, remanufactured, or refurbished. All products and parts replaced by EdgeStar under warranty service become the property of EdgeStar.

This warranty applies to the original purchaser only, and only covers defects in workmanship experienced during operation of the product under normal service, maintenance, and usage conditions. This warranty applies to the purchase and use of this product in residential settings within the United States of America.

WHAT IS NOT COVERED:

The following limitations apply to the coverage of this warranty. This warranty does not cover:

- Labor charges for installation, setup or training to use the product.
- Shipping damage, and any damage caused by improper packaging for shipment to an authorized service center, and any damaged caused by improper voltage or any other misuse, including abnormal service, handling, or usage.
- Cosmetic damage such as scratches and dents.
- Normal wear and tear on parts or replacement of parts designed to be replaced, e.g. filters, cartridges, batteries.
- Service trips to deliver, pick-up, or repair, install the product, or to instruct in proper usage of the product.
- Damages or operating problems resulting from misuse, abuse, operation outside environmental specifications, uses contrary to instructions provided in the owner's manual, accidents, acts of God, vermin, fire, flood, improper installation, unauthorized service, maintenance negligence, unauthorized installation or modification, or commercial use.
- Labor charges incurred 91 days or more after the date of original purchase.
- The use of EdgeStar products in commercial settings.
- Optional accessories, attachments, and appearance items.
- Products that have been modified to perform outside of specifications without the prior written permission of EdgeStar.
- Products lost in shipment, or theft.
- Products sold AS IS or from an unauthorized reseller.
- Products that have had their serial numbers removed or defaced. Products with serial numbers that have been invalidated.

OBTAINING WARRANTY SERVICE:

If you believe your product is defective, contact EdgeStar Customer Support for troubleshooting assistance and warranty service at 1-866-319-5473. Please have your serial number and proof of purchase available. Once an EdgeStar authorized representative has confirmed that your product is defective and eligible for warranty service, the product must be returned to an EdgeStar repair facility. The purchaser is solely responsible for prepaying all shipping related costs to and from the repair facility. EdgeStar is not responsible for damage resulting from shipper mishandling or improper packaging. Do not return a defective product to the place of purchase. Products received without a return authorization number will be refused.

THIS WARRANTY IS IN LIEU OF ANY OTHER WARRANTY, EXPRESSED OR IMPLIED, INCLUDING WITHOUT LIMITATION, ANY WARRANTY OF MERCHANTABILITY OR FITNESS FOR A PARTICULAR PURPOSE. TO THE EXTENT ANY IMPLIED WARRANTY IS REQUIRED BY LAW, IT IS LIMITED IN DURATION TO THE EXPRESS WARRANTY PERIOD ABOVE. NEITHER THE MANUFACTURER NOR ITS DISTRIBUTORS SHALL BE LIABLE FOR ANY INCIDENTAL, CONSEQUENTIAL, INDIRECT, SPECIAL, OR PUNITIVE DAMAGES OF ANY NATURE, INCLUDING WITHOUT LIMITATION, LOST REVENUES OR PROFITS, OR ANY OTHER DAMAGE WHETHER BASED IN CONTRACT, TORT, OR OTHERWISE. SOME STATES DO NOT ALLOW THE EXCLUSION OF INCIDENTAL OR CONSEQUENTIAL DAMAGES, SO THE ABOVE EXCLUSION MAY NOT APPLY TO YOU. THIS WARRANTY GIVES YOU SPECIFIC LEGAL RIGHTS. YOU MAY HAVE OTHER RIGHTS THAT VARY FROM STATE TO STATE.

Koldfront[®]

By
EdgeStar Products
500 N. Capital of TX Hwy, Bldg 5
Austin, TX 78746-3448

Toll Free: 1-866-319-5473
Web: <http://www.edgestar.com>
E-mail: service@edgestar.com

Register your product, download owner's manuals, access additional troubleshooting resources, and obtain more information on other great EdgeStar & Koldfront products on the web at: <http://www.edgestar.com>

Product contents and specifications may change without notice.

Copyright © 2015 Living Direct, Inc.