

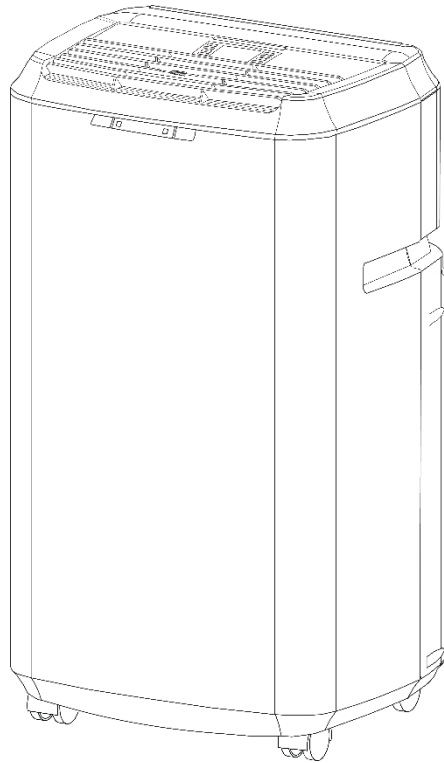

Portable Air Conditioner



PAC12020HSV

Owner's Manual

*For more information on other great Koldfront or EdgeStar products on the web, go to <http://www.edgestar.com>
To use the self-diagnostic tool, go to <https://support.edgestar.com>*

Important Safety Information

Improper handling can cause serious damage to the Koldfront Portable Air Conditioner and/or injury to the user. Please read the following safety information.



ELECTRICAL SAFETY

- This unit is designed for indoor use only.
- Do not use the unit in extremely humid or wet environments.
- Do not wet the housing or control panel.
- Do not pull the unit by the cord.
- Always turn the unit off and unplug it from the socket when cleaning.
- Unplug the unit if it is not going to be used for a long period of time.
- Do not operate the unit with a damaged plug or a loose socket.
- Use only the correct power supply with appropriate amperage.
- If the power cord is damaged, it must be replaced by the manufacturer, a service agent, or a qualified technician.
- Do not remove any part of the casing unless you are instructed to do so by an authorized technician.



GENERAL SAFETY

- This portable air conditioner is not intended to be used by children.
- Do not allow children to play with the controls or drop any objects into the air outlets or vents.
- Do not place objects or let any person sit on top of the unit.
- Only use in the upright position on a flat, level surface and provide at least 20 inches of clearance from any walls or objects.
- Route the power cord carefully to avoid a tripping hazard.
- This unit is intended for domestic and light commercial use only. Do not use the portable air conditioner for industrial purposes. Any other use may invalidate the warranty.

Operation of Safety Plug



Note: Electrical products should not be disposed of with household waste. Please contact your local recycling center for more information about how to recycle electronic waste.



Your portable air conditioner is supplied with a Leakage-Current Detection and Interruption (LCDI) safety plug. This device provides protection to reduce the risk of fire due to arcing faults in the power supply cord. Before using your portable air conditioner, follow the instructions below to ensure that the LCDI plug is working properly:

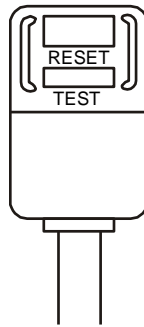

1. Plug the power cord to a grounded outlet.
2. Press the TEST button on the LCDI plug. This should trip the plug and cut the power to the air conditioner. If the plug does not trip and you are able to turn on the unit, please contact EdgeStar support.

DO NOT USE YOUR PORTABLE AIR CONDITIONER IF THE TEST FAILS.

Press the RESET button to start using your air conditioner.

Do not use the TEST and RESET buttons as an ON/OFF switch.

Table of Contents

<i>Important Safety Information</i>	<i>ii</i>
<i>Operation of Safety Plug</i>	<i>iii</i>
<i>Table of Contents</i>	<i>iv</i>
<i>Introduction</i>	<i>1</i>
<i>Parts Identification</i>	<i>2</i>
FRONT VIEW	2
BACK VIEW.....	2
<i>Window Kit Installation Instructions</i>	<i>3</i>
PREPARATIONS FOR INSTALLING THE WINDOW KIT.....	3
WINDOW KIT PARTS LIST.....	3
PARTS FOR CONTINUOUS AND MISTING DRAINAGE	3
INSTALLATION LOCATION.....	4
INSTALLING THE GRATED ADAPTER	4
INSTALLING THE WINDOW PLATES	5
ATTACHING THE DUCT CONNECTORS TO THE EXHAUST HOSE	6
CONNECTING THE DUCT CONNECTOR TO THE UNIT	6
CONNECTING THE DUCT CONNECTOR TO THE GRATED ADAPTER	7
NOTES ABOUT THE EXHAUST HOSE	7
<i>Draining the Unit</i>	<i>8</i>
DRAINAGE OPTIONS	8
<i>Operation</i>	<i>11</i>
REMOTE CONTROL OVERVIEW.....	11
INSTALLING THE BATTERIES	12
REMOTE CONTROL LCD INDICATORS	12
OPERATING THE REMOTE CONTROL.....	13
Auto-Restart:	13
Cooling Mode	13
FRONT PANEL LIGHTS AND CONTROLS	16
<i>Cleaning and Maintenance</i>	<i>17</i>
CLEANING THE UNIT	17
CLEANING THE PRE-FILTER	17
PREPARATION FOR STORAGE	17
<i>Energy Saving Guide</i>	<i>18</i>
<i>Troubleshooting</i>	<i>19</i>
<i>Specifications</i>	<i>21</i>
<i>New Portable Air Conditioner BTU's</i>	<i>22</i>
What is SACC?.....	22
<i>EdgeStar Limited Warranty</i>	<i>23</i>

First Time Operating Instructions:

Before use, make sure all packaging labels and materials are removed from the unit. Be sure to keep track of all included parts and pieces before discarding packaging materials. It is advised that you keep the original box and packaging materials in case you need to move or ship the appliance in the future.

Allow the unit to stand for at least 24 hours before you use it; this allows the cooling components time to settle from transit. The instruction manual should be read before use.

This owner's manual is provided for reference use only. Specifications may change without prior notice. Refer to the product label on your portable air conditioner for the latest technical information.

Introduction

Thank you for purchasing this Koldfront by EdgeStar portable air conditioner. We hope that this purchase will be the beginning of a lasting and rewarding relationship between you and EdgeStar. We will provide the customer support and exemplary products necessary to nurture that relationship.

This manual contains important information regarding the proper installation, use, and maintenance of your portable air conditioner. Following this manual will ensure that your product will work at its peak performance, efficiency, and safety.

Please save the original product packaging in case you need to safely transport your portable air conditioner.

For Your Records:

Please write down the model number and serial number below for future reference. Both numbers are located on the ratings label on the back of your unit and are needed to obtain warranty service. You may also want to staple your receipt to this manual as it is the proof of your purchase, and is also needed for service under your warranty.

Model Number: _____

Serial Number: _____

Date of Purchase: _____

For a more efficient experience, please do the following before contacting customer service:

- If you received a damaged product, immediately contact the dealer that sold you the product.
- Read and follow this instruction manual carefully to help you install, use and maintain your portable air conditioner.
- Read the troubleshooting section of this manual as it will help you diagnose and solve common issues.
- Visit us on the web at <https://www.edgestar.com> for product guides, additional troubleshooting resources, and up-to-date information. You can also find an interactive self-diagnostic tool at <https://support.edgestar.com>. If you need service, our friendly customer service representatives are available via email at service@edgestar.com.

Parts Identification

FRONT VIEW

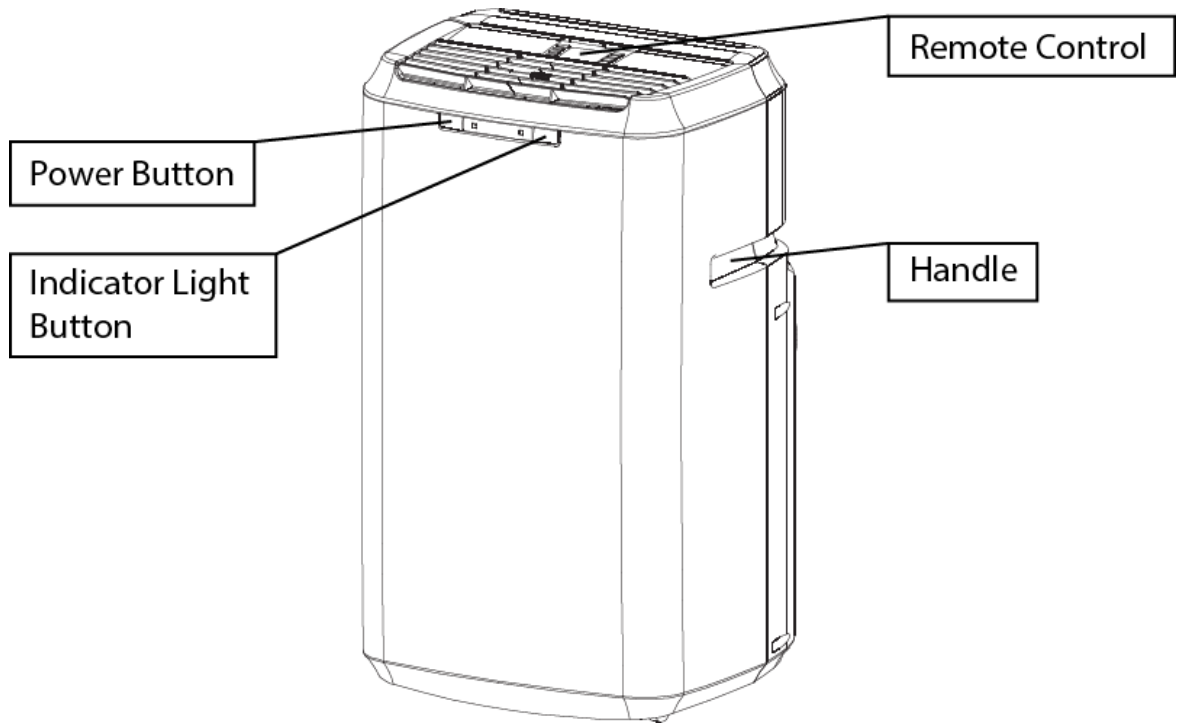

BACK VIEW

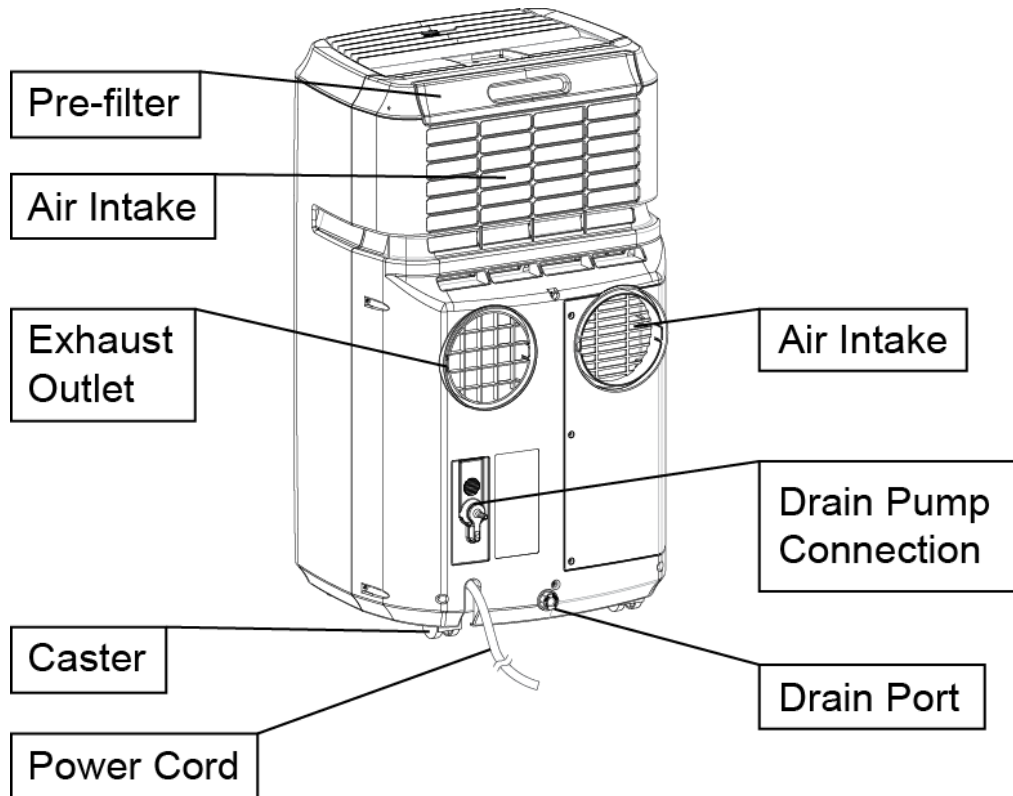

Caution: Make sure the drain plug is firmly installed before using the unit to prevent leaking.

Window Kit Installation Instructions

PREPARATIONS FOR INSTALLING THE WINDOW KIT

You must vent your portable air conditioner when running it in cooling mode or heat mode (certain models). Your unit includes a window exhaust kit that can be used to vent the unit out of a window. Before you begin, make sure you have all the parts necessary for installation.

WINDOW KIT PARTS LIST

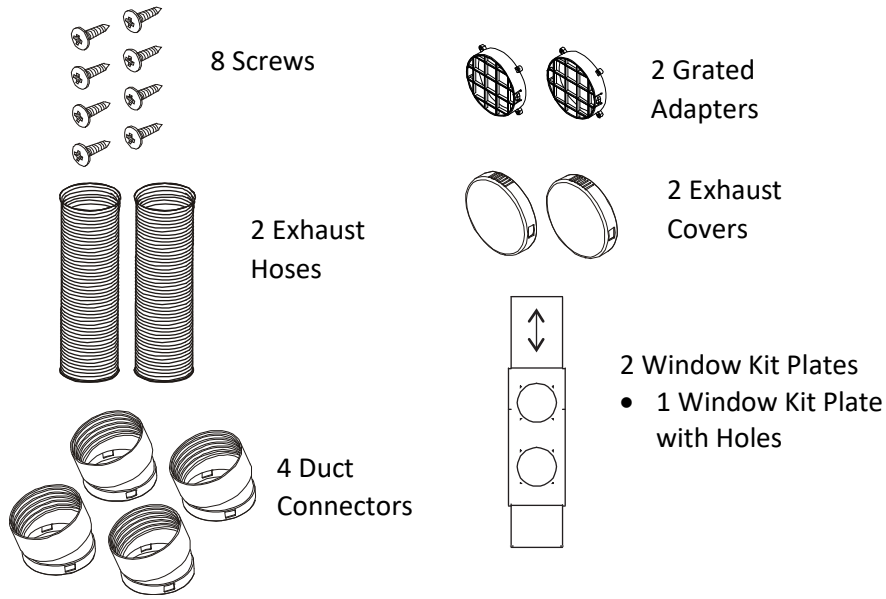

Note: There is one duct connector that includes an opening for the water line for use in the misting drain operation. This connector must be installed to the exhaust outlet on the unit. Please review pages 8-10** for more details.

PARTS FOR CONTINUOUS AND MISTING DRAINAGE

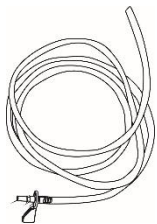

1 Water Line

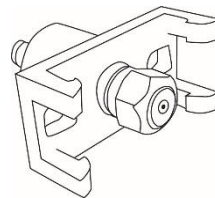

1 Misting Nozzle

INSTALLATION LOCATION

If you have multiple windows, choose one that is near an electrical outlet that will be able to provide sufficient power to your unit. See the power requirements listed on the product label printed on the side, or on the back of your portable air conditioner.

Your window kit can be installed on a horizontal or vertical sliding window as shown in the following pictures:

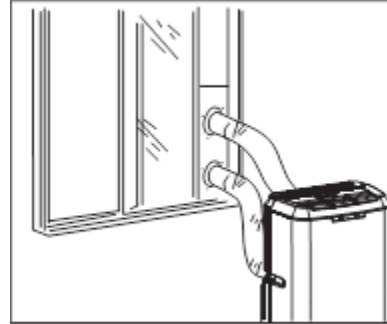
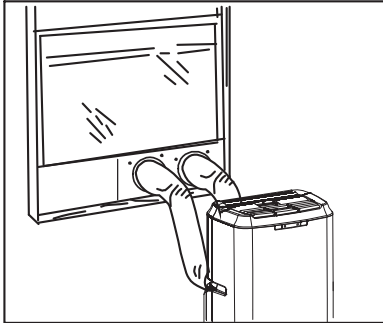

Note: Exhaust Covers may be attached to the Grated Adapters. You may need to twist and pull apart to separate them.



Note: You may need to contact your electrician if your room's circuit is not able to power your unit.

INSTALLING THE GRATED ADAPTER

1. Insert the round grated adapters through the back grooved side of the window kit plate with holes.

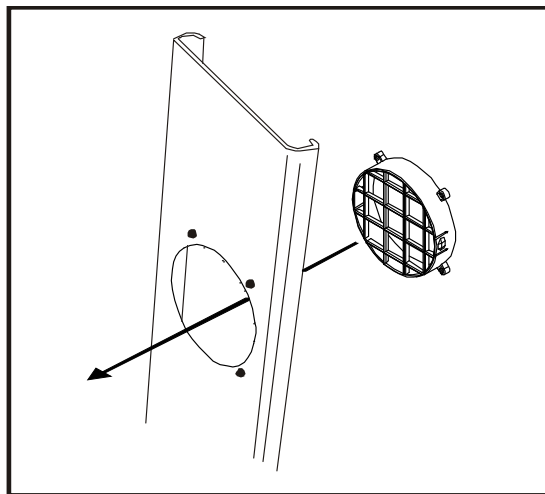

- Secure the grated adapters by fastening the screws from the flat side of the window kit plate to the holes on the grated adapter.

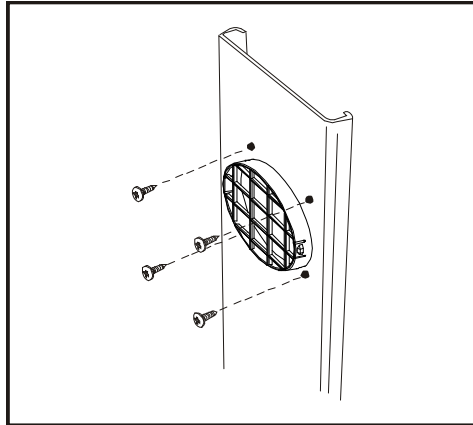

INSTALLING THE WINDOW PLATES

- Open your window and place the window kit on the window sill with the grooved side facing outward. Then, slide the window kit plate to fit the width of the window. You can use screws to secure the window kit plate from sliding.

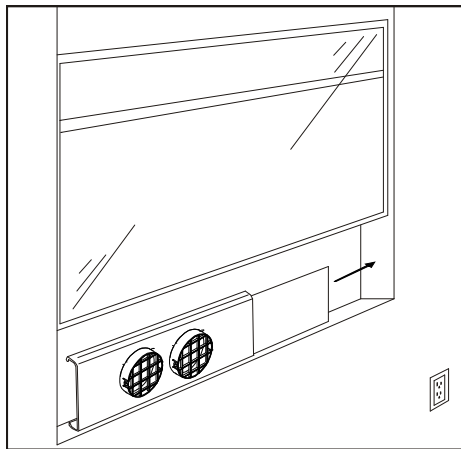

- Lower the window to secure the window kit in place. You may need to use duct tape to better secure the window kit.

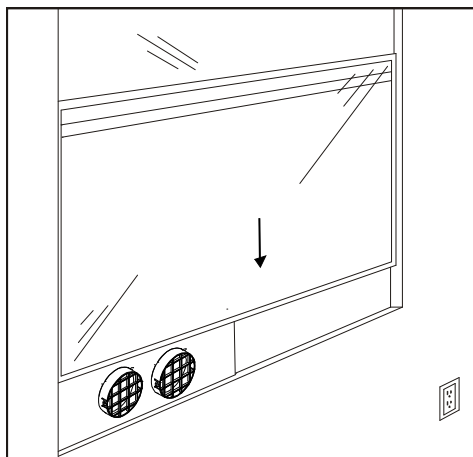

ATTACHING THE DUCT CONNECTORS TO THE EXHAUST HOSE

5. Attach the connectors to the hose.
 - A. Extend the ends of the exhaust hose
 - B. Thread the duct connector on by turning it clockwise until it stops.

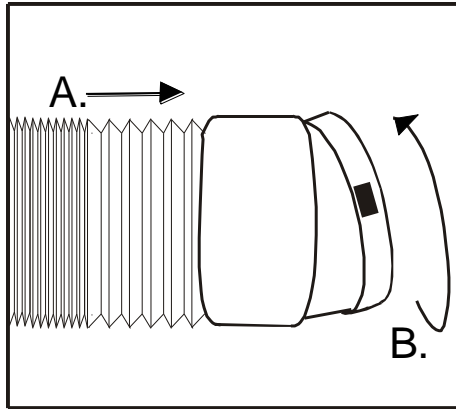

6. Roll the unit towards the window kit. Leave a space that is at least 20 inches to the wall.

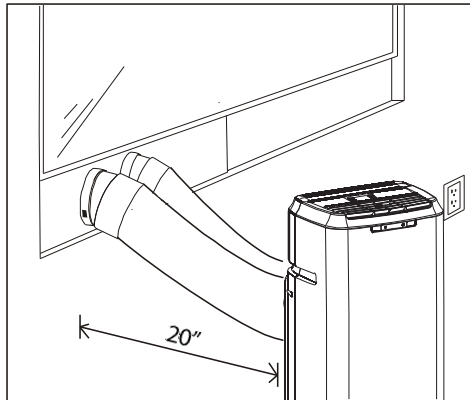

CONNECTING THE DUCT CONNECTOR TO THE UNIT

7. Align the slots on the duct connector to the tabs and snap the duct connector into the back of the unit. In order to use the misting drain feature you will need to attach the duct connector with an opening for the water line to the exhaust outlet on the unit.

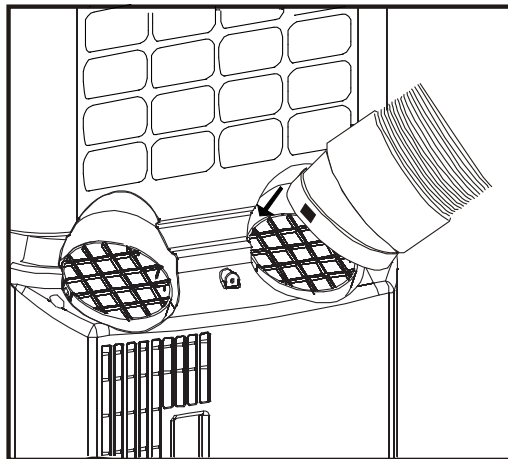

CONNECTING THE DUCT CONNECTOR TO THE GRATED ADAPTER

- Align the slots on the duct connector to the tabs on the grated adapter and snap the duct connector into place.

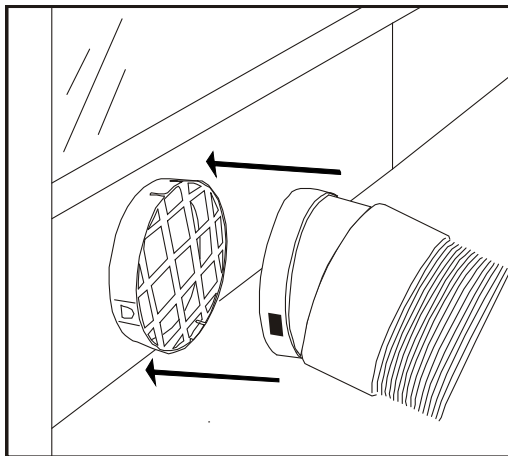

After you have installed the exhaust hose and window kit, you can plug in your portable air conditioner and start using it.

NOTES ABOUT THE EXHAUST HOSE

Your portable air conditioner is designed to exhaust condensate water that is collected from the air. This water, in either gaseous or droplet form, will be expelled out of the exhaust port of the unit. Please take this into account when deciding how to vent it.

- The exhaust hose supplied with the portable air conditioner can be extended up to 48 inches; however for maximum efficiency, use the shortest length possible.
- Try to prevent any kinks or bends in the exhaust hose. Kinks or bends may trap exhaust air which can radiate heat into the room or potentially cause the portable air conditioner to overheat and shut itself off.
- The exhaust hose supplied with the portable air conditioner has been specifically designed for this air conditioner. Do not lengthen the hose by adding additional hoses or attachments or replace it with any other hose.

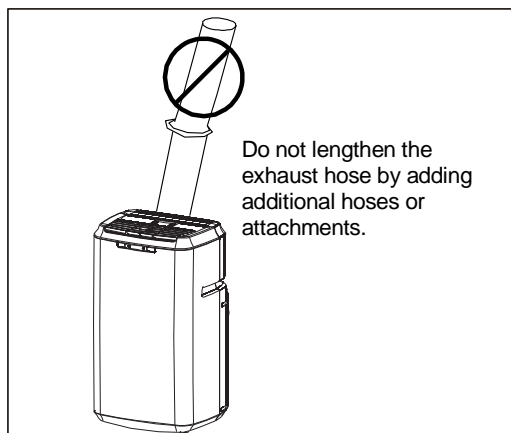

Warning: Longer hoses are not recommended.

Draining the Unit

When the portable air conditioner is in cooling mode, dehumidify mode, or heat mode on certain models, it will remove moisture from the air. The condensed water from the air will be collected in an internal reservoir and will be evaporated and exhausted out of the exhaust hose. However, in very humid conditions, the internal reservoir may fill completely. This causes the air conditioner to turn off to avoid overflowing the internal reservoir. The WATER indicator will light up on the Control Panel.

Direct Drainage

1. Remove the rubber drain plug from the drain port.
2. Connect a drain hose to the drain port.

The portable air conditioner will now drain through the drain hose.

DRAINAGE OPTIONS

Your Koldfront portable air conditioner comes with several different options for draining the water accumulated during operation. The most common will be the self-evaporative mode. The unit will do this automatically. This mode will be sufficient for most environments. If you are operating the unit in an environment with higher levels of humidity you may choose one of the other drainage options to help remove the excess water.

Continuous Drain

This unit has the capacity for continuous drainage. It includes an internal pump to help remove water. This means the unit will push the water to the drain instead of relying on gravity to bring the water to the drain. If there is an obstacle in between the unit and the drain, the pump will push the water over that obstacle and through the water line. In order to run the continuous drain function you will need to do the following:

1. Connect the included water line to the unit. You will need to attach the quick connect adapter on the end of the water line to the back of the unit.

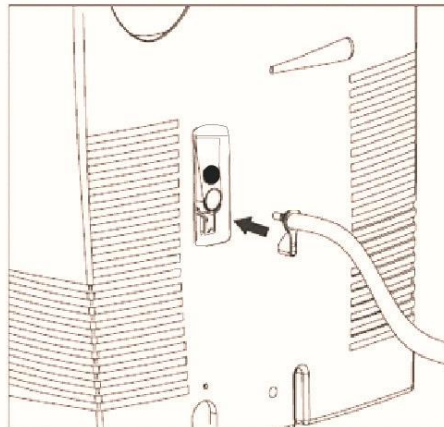

2. Place the other end of the water line (drainage end) into a drain. The unit will recognize that the quick adapter is attached and will automatically engage the water pump. The pump will turn on once the water reservoir becomes full.

Misting Drain

Your unit also includes the unique Misting Drain option. If a drain is not present this option will allow the unit to remove the excess moisture out of the exhaust hose through a mist nozzle. The mist nozzle **MUST** be setup in the exhaust hose and **NOT** the intake hose. In order to run the misting drain option you will need to do the following:

1. Connect the included water line to the unit. You will need to attach the quick connect adapter on the end of the water line to the back of the unit.

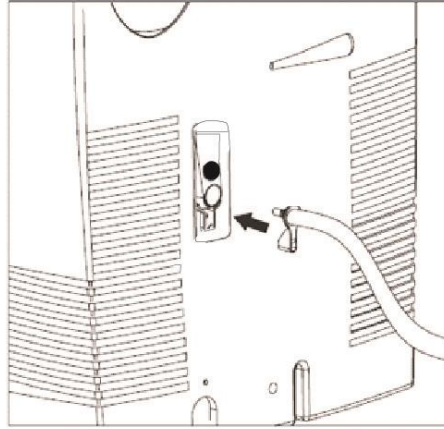

Note: The water line quick connect includes a trigger to let the unit know a water line is attached. The unit will not pump water out of this drainage hole unless the quick connect water line is attached.

2. Run the remaining water line into the exhaust hose through the opening in the exhaust hose adapter. This adapter **MUST** be installed on the exhaust outlet of the unit. If the adapter is not installed in this position you will need to adjust the adapters. Run the excess water line into the cavity of the exhaust hose.



Caution: The water line will contain some water if the pump has been in use. If you are going to detach the water line from the unit be sure to keep the end of the water line elevated once it is detached to avoid water spilling. Drain the remaining water in the water line if you are preparing for storage of the unit.

3. Connect the mist nozzle to the end of the water line. Ensure the water line is attached securely to the mist nozzle.

4. Attach the mist nozzle to the grated adapter. Make sure the mist nozzle is directed to mist outside of the window and not back into the exhaust hose.

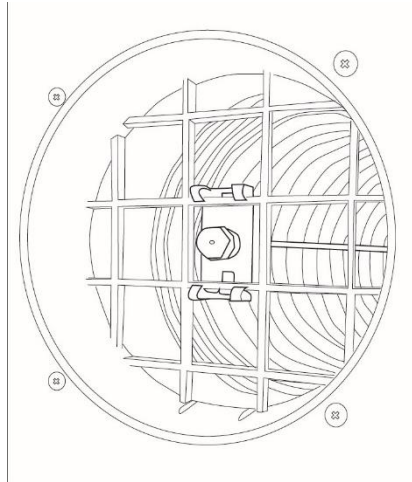

The unit will now automatically mist any excess water to the outside. Installing the mist system in the exhaust hose ensures all of the moisture is pushed completely away from the window.



Note: It is recommended to attach the misting nozzle in a vertical position on the grated adapter.

To remove the water line from the unit:



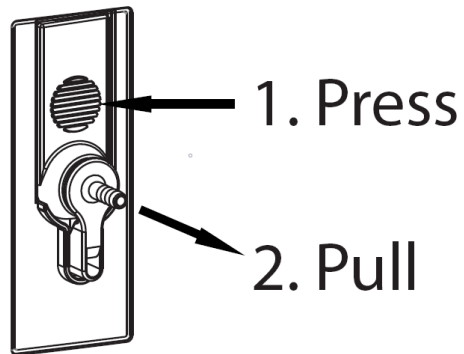





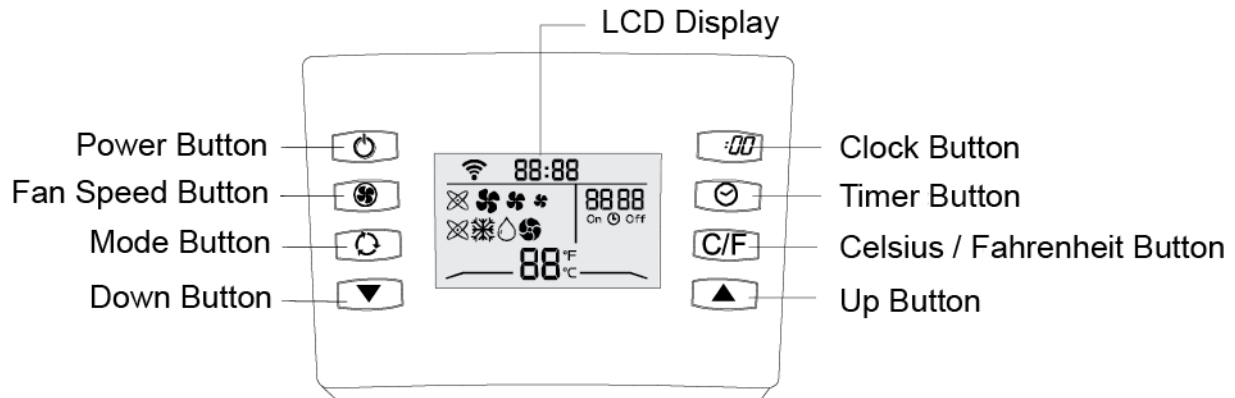







1. Press in on the circular impression and hold.
2. Pull the quick connect adaptor straight out of the unit.



Operation

REMOTE CONTROL OVERVIEW



Button	Function
 Power	This button powers the unit on or off.
 Fan Speed	This button sets the fan speed. The  Automatic,  High,  Medium, or  Low indicator will appear depending on the mode you set.
 Mode	This button sets the mode. The  Automatic,  Cool,  Dehumidify,  Fan, or  heat indicator will appear depending on the mode you set.
 (Down)	This button decreases the Temperature, Timer, or Clock settings.
 (Clock)	This button is used to set the remote control clock
 Timer	This button is used to enable the timer.
 C/F	This button switches the temperature between Celsius / Fahrenheit
 (Up)	This button increases the Temperature, Timer, or Clock settings.

INSTALLING THE BATTERIES

1. Remove the cover on the back of the remote control.
2. Insert the batteries with the (+) and (-) ends pointing in the correct direction.
3. Slide the cover back on.





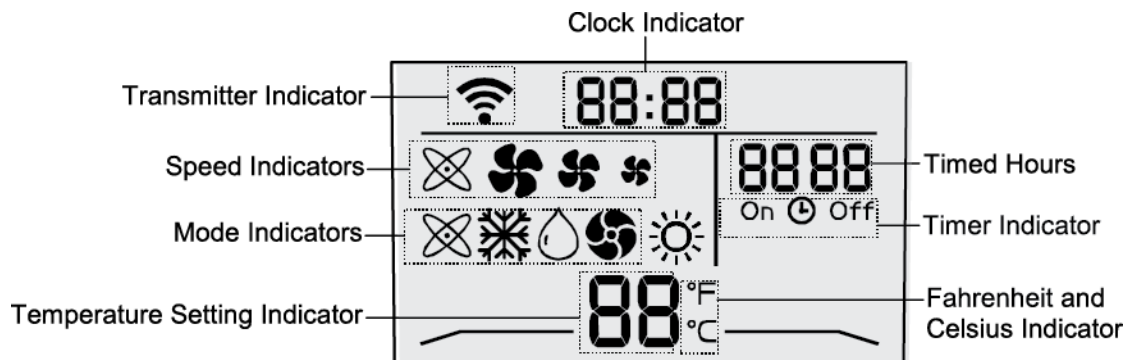

Caution: Use only AAA batteries. Remove the batteries if the remote control will not be used for one month or longer. Do not attempt to recharge batteries not designed to be recharged. All batteries should be replaced at the same time. Do not mix old and new batteries. Do not dispose of batteries in a fire as they may explode.

REMOTE CONTROL LCD INDICATORS



Indicators	
Transmitter	This indicator appears when the Power or Timer button is signaling the unit.
Fan Speed	This indicator shows the set fan speed between Automatic, High, Medium, and Low.
Mode	This indicator shows the set mode between Automatic, Cooling, Dehumidify, Fan Only, and Heat.
Temperature Setting	This indicator shows the set temperature.
Fahrenheit and Celsius	This indicator shows if the set temperature is in Fahrenheit or Celsius.
Clock	This indicator shows the Clock's time. The remote control has a 24-Hour clock.
Timed Hours	This indicator shows the number of timed hours when the Timer is enabled.
Timer	This indicator shows if the On Timer or Off Timer is enabled.

Mode Indicator	Function
 Automatic	The unit will cool, dehumidify, or heat (some models) depending on the ambient temperature. The mode and fan speed changes automatically. The front panel lights will change to reflect the running mode.
 Cooling	The unit will cool. The front panel lights will be blue.
 Dehumidify	The unit will remove moisture from the air. The front panel lights will be yellow.
 Fan Only	The unit will run as a fan and circulate air. The front panel lights will be green.
 Heat	<i>Available on certain models.</i> The unit will heat. The front panel lights will be red.

OPERATING THE REMOTE CONTROL

Power

Use the  Power button to turn the portable air conditioner on and off.







By default when you first use the power button, the unit will begin to operate in cooling mode and the front panel will be illuminated in blue. The unit will remember the last used mode / settings if you shut down and restart.

Auto-Restart: If power to the unit is interrupted, the air conditioner will restart itself in its last used mode / settings once power is restored. The compressor will restart after 3 minutes.

Cooling Mode

Cooling mode cools and dehumidifies the air. If the ambient temperature drops below the temperature you selected, the compressor turns off and the unit functions with the fan only. When the temperature rises above the temperature you selected, the compressor turns on again. The front panel lights will be blue. Whether your desired temperature can actually be reached depends on the ambient conditions. The room temperature remaining above the set temperature is normal.

To operate the unit in cooling mode:

1. Make sure the power cord is plugged into a power outlet.
2. Press the  Power button on the remote control.
3. Press the  Mode button until the  cooling indicator is selected.
4. Select the fan speed by using the  Speed button.
5. Set the thermostat by using the  Up and  Down buttons. The thermostat is adjustable between 64° F - 90° F in one degree increments. You can switch between Fahrenheit and Celsius by pressing the  button.





Note: The exhaust hose must be used in Cooling mode in order to cool a room.

Dehumidifying Mode

During the Dehumidifying mode, the unit will condense water out of the air and exhaust it through the exhaust hose. The ambient temperature in the room will probably drop by a few degrees while using the Dehumidifying mode. The front panel lights will be yellow.

To operate the unit in dehumidifying mode:

1. Make sure the power cord is plugged into a power outlet.
2. Press the  Power button on the remote control.
3. Press the  Mode button until the  dehumidify indicator is selected.







Notes: If the room temperature is below 77° F, the fan will always run on low speed in this mode. If you do not use the exhaust hose in Dehumidify Mode, you must manually drain the water from the unit.

Heat Mode

This mode allows the unit to run as a heat pump. The unit must be vented for it to expel the cold air out of the exhaust.









To operate the unit in heat mode:

1. Press the  Mode button until the  heat indicator is selected.
2. Set the thermostat by using the  Up and  Down buttons.

Fan Only Mode

Fan Only mode is used to circulate the air in your room. No temperature setting is needed. The front panel lights will be green.

To operate the unit in Fan Only mode:

1. Make sure the power cord is plugged into a power outlet.
2. Press the  Power button on the remote control.
3. Press the  Mode button until the  Fan Only indicator is selected.
4. Press the  Speed button to select the fan speed. You can choose between  Automatic,  High,  Medium, and  Low.





Note: Fan Only mode does not require that the exhaust hose be attached.

Automatic Mode





In Automatic mode, the unit will cool, dehumidify, or heat (certain models) depending on the ambient temperature. As the temperature in the room changes, the mode and fan speed will change automatically. The front panel lights will change depending on the mode. You cannot select a specific temperature in this mode. For more precise control, run the air conditioner in either Cool Mode or Heat Mode (certain models).

To operate the unit in Automatic mode:

1. Make sure the power cord is plugged into a power outlet.
2. Press the  Power button on the remote control.
3. Press the  Mode button until the  Automatic indicator is selected.

Fan Speed

The  Fan Speed button is used to change the fan speed while in Cooling and Fan Only modes.

Press the  Fan Speed button to select the fan speed. The  Automatic,  High,  Medium, or  Low indicator can be selected.







Note: You will not be able to change the fan speed if the unit is in Automatic or Dehumidify mode.

Clock

The  Clock button is used to set the Clock.

To set the Clock:

1. Press and hold the  Clock button until the Clock indicator starts blinking.
2. Set the time by using the  Up and  Down buttons. Holding down the buttons longer than 1 second will change the time in fast mode. The clock is a 24-Hour clock so if it is 6:00 PM you would set the time to be 18:00.
3. To save your settings press and hold the  Clock button until the Clock indicator stops blinking.





Use the Chart below to set the 24-hour clock:

12-Hour	24-Hour
1:00 PM	13:00
2:00 PM	14:00
3:00 PM	15:00
4:00 PM	16:00
5:00 PM	17:00
6:00 PM	18:00
7:00 PM	19:00
8:00 PM	20:00
9:00 PM	21:00
10:00 PM	22:00
11:00 PM	23:00
12:00 AM	00:00





Timer

The timer can be used to either turn the unit on or off after a number of elapsed hours. The timer is adjustable between 1-24 hours in one hour increments.

How to set the unit to automatically turn on:

1. Press the  Timer button while the unit and remote are powered off. The On Timer [On ] indicator will be selected and the timed hour indicator will be blinking.
2. Use the  Up and  Down buttons to set the number of hours you want to pass before the unit turns on.
3. Press the  Timer button again to set the timer. The timed hour indicator will stop blinking. After the selected time passes, the unit will automatically turn on.

How to set the unit to automatically turn off:

1. Press the  Timer button while the unit and remote are powered on. The Off Timer [ Off] indicator will be selected and the timed hour indicator will be blinking.
2. Use the  Up and  Down buttons to set the number of hours.
3. Press the  Timer button again to set the timer. The timed hour indicator will stop blinking. The unit will automatically turn off after the selected time elapses.



Note: To cancel the timer, press the  Power button or set the timer to “00”.

FRONT PANEL LIGHTS AND CONTROLS

Front Panel Lights

Your portable air conditioner has a front panel that lights up different colors depending on the mode it is running in.

Cooling mode will display a blue light.

Dehumidify mode will display a yellow light.

Fan mode will display a green light.

Heating mode (on certain models) will display a red light.

Automatic mode will display the color current mode that has been automatically selected.

If the unit flashes a red light and the unit stops cooling, this indicates that the internal water reservoir is full. Place a pan under the unit, and remove the drain plug to drain the unit.

If the lights flash from left to right and the unit does not work, contact customer service.

Front Panel Controls



The front panel has an emergency power switch. The power switch can be used when the unit needs to be shut off or turned on without the remote control.



You can turn off the front panel lights by pressing the Lamp Off switch.

Cleaning and Maintenance

Clean the air conditioner and filters regularly to maximize performance and efficiency, and prolong the unit's life. Always be sure to unplug the air conditioner from the power outlet before cleaning.

CLEANING THE UNIT

Use a soft dry cloth to wipe the body clean. If necessary, use lukewarm water to dampen a cloth to clean the unit.

Use a soft bristle brush to clean between the vents.

Carefully use a vacuum cleaner to clean the condenser coils

Never use abrasive chemicals, volatile substances, gasoline, detergents, chemically treated cloths, or other cleaning solvents that may damage the cabinet exterior.

Never spray water directly on the unit.

CLEANING THE PRE-FILTER

To clean the pre-filter, follow the steps below:

1. Power off the unit and remove the pre-filter.
2. Use a vacuum cleaner or tap the filter lightly to remove loose dust and dirt, then rinse thoroughly under lukewarm running water (below 104° F). You may use a mild soap and water solution if needed. Allow the pre-filter to air dry in a cool and shaded place. Dry the pre-filter thoroughly before reinstalling it.

Clean the pre-filter periodically. If the unit is used in a dusty environment you may need to clean it on a weekly basis.



Warning: Never operate the unit without the filter.

PREPARATION FOR STORAGE

If you are not going to be using the unit for an extended period of time, follow the instructions below before storing your unit:

1. Drain all the water from the unit's reservoir. Operate the unit in fan mode for a few hours to thoroughly dry any moisture left on the coils inside the unit.
2. Power off the unit, and clean or change the filter.
3. Unplug and carefully wind the power cord.
4. Remove the exhaust hose and duct connectors and keep them in a safe place.

Energy Saving Guide

Read and follow the guide below to get the best performance and efficiency from your portable air conditioner:

- Do not cover the air outlet (exhaust) while the unit is in use.
- Do not place the unit in front of curtains or drapes to ensure that the air intake is not obstructed.
- Minimize the length of the exhaust hose.
- Make sure the exhaust hose is as straight as possible and avoid kinks or bends.
- Keep curtains, blinds, or drapes closed during the sunniest part of the day.
- Use the timer to operate the unit before it is needed. For example, set the timer to turn on the unit in cooling mode for 3 or more hours to cool the room before you arrive. You may want to operate the unit all day if you live in a warmer climate.
- Minimize the heat sources (direct sunlight, computers, servers, people, etc.) in the room.
- Close all windows and doors.
- Use the unit in a contained room. For example, use the unit in a room with four walls and a ceiling, instead of a partitioned studio, or warehouse.
- Make sure the unit is on a level surface.
- Minimize the amount of humidity in the room. For example, run the unit as a dehumidifier.
- To prolong the compressor's life, please wait at least 3 minutes before turning the unit back on after shutting it off.
- Inspect and clean the pre-filters regularly.
- Perform routine maintenance.

Troubleshooting

Follow the troubleshooting guide below to resolve common issues.

ISSUE	POSSIBLE CAUSE	SOLUTION
My air conditioner is not functioning at all.	The unit is not receiving power.	Make sure the unit is plugged in.
	The LCDI power cord is tripped.	Press the Reset button on the LCDI cord.
	There is insufficient power to the unit.	Move the unit to another outlet. Check your circuit breaker. (Refer to the rating label on the back of the unit to determine the Amperage draw.)
	The water reservoir is full.	Drain the unit and restart it.
	The control panel is disconnected.	If no indicator lights turn on, contact customer service.
My remote control does not work and the indicator symbols on the remote do not appear.	The batteries are not installed.	Install new batteries.
	The batteries in the remote are bad.	Replace the batteries.
	The batteries were installed incorrectly.	Reinstall the batteries correctly.
	The remote control is defective.	Contact customer service.
My air conditioner is making a loud noise.	The unit is not level.	Make sure the unit is on a level surface.
	A foreign object has jammed the fan.	Remove the object from the fan.
	The floor below the unit is uneven.	Move the unit to a level surface.
My air conditioner is making a continuous metallic knocking or pinging sound.	The unit may have been shipped on its side.	Shut off the unit. Let the unit sit on a level surface for at least 24 hours and restart it.
	The compressor is damaged.	Contact customer service.
My air conditioner is leaking.	The drain plug is removed.	Attach the drain plug.
	The base pan is cracked.	Contact customer service.
My air conditioner runs for a little while and then it trips the power cord or the circuit breaker.	The air conditioner may be plugged into an outlet that cannot supply the correct amount of current.	Contact an electrician if the unit works in a different room or circuit.
The front control panel lights blink red.	Your water reservoir is full.	Drain your unit.

ISSUE	POSSIBLE CAUSE	SOLUTION
My air conditioner is not cooling at all.	The unit is not operating in cooling mode.	Set the unit to be in cooling mode, and lower the set temperature (pg. 13).
	The compressor is not on.	The compressor may take up to 3 minutes to turn on, or longer if it is too warm.
	The ambient temperature is too high.	Lower the room temperature to be below 90° F.
	The filter may be dusty or blocked.	Clean the filter (pg. 17).
	The exhaust port is blocked.	Remove any obstructions in the exhaust hose and port.
My air conditioner blows cold air, but does not lower the room temperature.	The unit is not vented.	The unit must be vented (pg. 3).
	The area of the room is too large.	Minimize the size of the area to be cooled, i.e. adding a drop ceiling. Use more than one unit to cool the area, or use a larger unit.
	There are open windows and doors.	Close any open doors and windows.
	There are too many heat sources.	Remove or shut off additional heat sources such as radio equipment, servers, etc.
	The room / garage may be inadequately insulated.	Properly insulate the room to be cooled, i.e. using fiberglass.
	The ambient temperature is too high.	The unit may not work if the room temperature is above 90° F.
	Direct sunlight is heating the room.	Close curtains or pull down blinds to minimize the amount of direct sunlight entering the room.
	The filter is dusty or blocked.	Clean the filter and replace it if necessary.
	The condenser coils are dirty.	Carefully vacuum the coils clean.
	The air intake or exhaust ports are obstructed.	Remove anything blocking the ports.



Note: If the ambient temperature is above 90° F the unit may not blow cold air.



Tip: Run the unit before it is needed. For example, run the unit in the morning before the area gets hot, and continue to run the unit all day long in order to maintain a low temperature.

Specifications

DESCRIPTION OF PRODUCT	Portable Air Conditioner with Heater
MODEL	PACI12020HSV
BTUs	Cooling: 12,000 Heating: 10,000
VOLTAGE / FREQUENCY	115 V / 60 Hz
INPUT POWER	1,000 W
CURRENT	9.5 A
COOLING CAPACITY (SACC)	5500 BTU
COOLING CAPACITY (ASHRAE)	12000 BTU
COLOR	Silver and Grey
COOLANT	R410A
TIMER	24 Hour
DIMENSIONS (HEIGHT X WIDTH X DEPTH)	29 ³ / ₁₆ " X 17 ¹ / ₈ " X 15 ¹ / ₈ "
NET WEIGHT	69 Pounds



Note: Technical data and performance information are provided for reference only. Specifications are subject to change. Check the rating label on the portable air conditioner for the most accurate information.

New Portable Air Conditioner BTU's

You may notice that the cooling capacities (in British Thermal Units or BTU's) labeled on portable air conditioners (PAC's) are now lower than on models produced prior to October 1, 2017. This is because the labeling on new productions of PAC's must follow a new federal test standard that was established by the Department of Energy: 10 CFR 430, subpart B, appendix CC.

The SACC rating shown on your new PAC is a result of this new standard. Models manufactured before 2017 were tested under a different standard (ASHRAE) that produced a higher cooling capacity output. While the SACC BTU's are lower than the previous ASHRAE BTU's, the construction and cooling capacity of this model(s) remains unchanged. Both the SACC and ASHRAE ratings are included for consumer comparison.

What is SACC?

SACC, or the Seasonally Adjusted Cooling Capacity, is a rating in BTU/hour that represents the weighted average performance of a PAC in a number of test conditions, some of which may be more extreme than the average use case, which is then adjusted to account for the effect of infiltration air and duct heat transfer. The factors included in the SACC calculation are why the ratings appear lower, even though the model(s) has not changed.

EdgeStar Limited Warranty

One (1) Year Parts & Ninety (90) Days Labor

This product is warranted by EdgeStar to be free from defective workmanship and materials, subject to any conditions set forth as follows:

WHAT IS COVERED:

LABOR: For a period of NINETY (90) DAYS from the date of original purchase, labor will be performed free of charge at an authorized EdgeStar repair facility. At its option, EdgeStar will repair the product with new or remanufactured parts, or exchange the defective product with a new, refurbished, or remanufactured product. If a product is replaced, it will carry the remaining warranty of the original product. After the ninety (90) day period, EdgeStar will no longer be responsible for labor charges incurred. All defective products and parts covered by this warranty will be repaired or replaced on a mail-in basis to an EdgeStar authorized repair facility.

PARTS: For a period of ONE (1) YEAR from the date of original purchase, EdgeStar will supply new, rebuilt, or refurbished parts free of charge. EdgeStar may request a defective part be returned in exchange for the replacement part. All replacement parts or products will be new, remanufactured, or refurbished. All products and parts replaced by EdgeStar under warranty service become the property of EdgeStar.

This warranty applies to the original purchaser only, and only covers defects in workmanship experienced during operation of the product under normal service, maintenance, and usage conditions. This warranty applies to the purchase and use of this product in residential settings within the contiguous United States of America.

WHAT IS NOT COVERED:

The following limitations apply to the coverage of this warranty. This warranty does not cover:

- Labor charges for installation, setup or training to use the product.
- Shipping damage, and any damage caused by improper packaging for shipment to an authorized service center, and any damaged caused by improper voltage or any other misuse, including abnormal service, handling, or usage.
- Cosmetic damage such as scratches and dents.
- Normal wear and tear on parts or replacement of parts designed to be replaced, e.g. filters, cartridges, batteries.
- Service trips to deliver, pick-up, or repair, install the product, or to instruct in proper usage of the product.
- Damages or operating problems resulting from misuse, abuse, operation outside environmental specifications, uses contrary to instructions provided in the owner's manual, accidents, acts of God, vermin, fire, flood, improper installation, unauthorized service, maintenance negligence, unauthorized installation or modification, or rental or commercial use.
- Labor, service transportation, and shipping charges incurred 91 days or more after the date of original purchase.
- The use of EdgeStar products in commercial or rental settings.
- Optional accessories, attachments, and appearance items.
- Products that have been modified to perform outside of specifications without the prior written permission of EdgeStar.
- Products lost in shipment, or theft.
- Products sold AS IS or from an unauthorized reseller.
- Products that have had their serial numbers removed or defaced. Products with serial numbers that have been invalidated.
- Damage to personal property from use of product.
- Replacement of repair of household fuses, circuit breakers, wiring, or plumbing.

OBTAINING WARRANTY SERVICE:

If you believe your product is defective, contact EdgeStar Customer Support for troubleshooting assistance and warranty service at www.edgestar.com. Before contacting EdgeStar, have your serial number and proof of purchase available. Once an EdgeStar authorized representative has confirmed that your product is defective and eligible for warranty service, the product must be returned to an EdgeStar repair facility. The purchaser is solely responsible for prepaying all shipping related costs to and from the repair facility. EdgeStar is not responsible for damage resulting from shipper mishandling or improper packaging. Do not return a defective product to the place of purchase. Products received without a return authorization number will be refused.

THIS WARRANTY IS IN LIEU OF ANY OTHER WARRANTY, EXPRESSED OR IMPLIED, INCLUDING WITHOUT LIMITATION, ANY WARRANTY OF MERCHANTABILITY OR FITNESS FOR A PARTICULAR PURPOSE. TO THE EXTENT ANY IMPLIED WARRANTY IS REQUIRED BY LAW, IT IS LIMITED IN DURATION TO THE EXPRESS WARRANTY PERIOD ABOVE. NEITHER THE MANUFACTURER NOR ITS DISTRIBUTORS SHALL BE LIABLE FOR ANY INCIDENTAL, CONSEQUENTIAL, INDIRECT, SPECIAL, OR PUNITIVE DAMAGES OF ANY NATURE, INCLUDING WITHOUT LIMITATION, LOST REVENUES OR PROFITS, OR ANY OTHER DAMAGE WHETHER BASED IN CONTRACT, TORT, OR OTHERWISE. In no event and under no circumstance of any type or kind shall the seller, manufacturer and/or distributor be liable for any reason, under any theory, for more than the basic cost of the product to the purchaser or end user. SOME STATES DO NOT ALLOW THE EXCLUSION OF INCIDENTAL OR CONSEQUENTIAL DAMAGES, SO THE ABOVE EXCLUSION MAY NOT APPLY TO YOU. THIS WARRANTY GIVES YOU SPECIFIC LEGAL RIGHTS. YOU MAY HAVE OTHER RIGHTS THAT VARY FROM STATE TO STATE.