

18 GAUGE STAINLESS STEEL KITCHEN SINK 31 1/2"

Undermount Series

- 18 Gauge Stainless Steel
- 18-10 Chrome Nickel content
- Large bowl/small bowl combination sink
- Installation hardware, template and instructions included
- **Waste fittings included**
- **36" cabinet required**

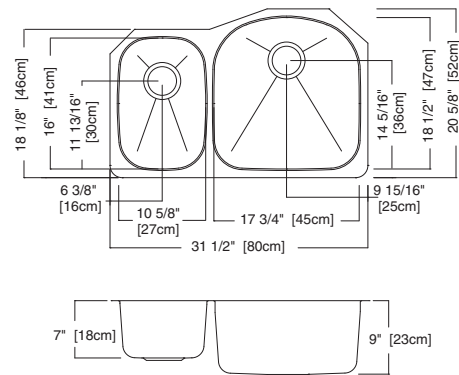

Nominal Dimensions:

31 1/2" x 20 5/8" x 9"

Large Bowl Size:

17 3/4" wide

18 1/2" front to back

9" deep

Small Bowl Size:

10 5/8" wide

16" front to back

7" deep

Compliance Certifications:

IMPORTANT: Dimensions of fixtures are nominal and may vary within the range of tolerances established by ASME A112.19.3
These measurements are subject to change or cancellation. No responsibility is assumed for use of superseded or voided leaflet.

To Be Specified:

- 8443.101500.075  Stainless steel mesh colander
- 8445.161700.075  Stainless steel bottom grid
- 8445.081400.075  Stainless steel bottom grid