

AXOR®

hansgrohe

DE	Gebrauchsanleitung / Montageanleitung	2
FR	Mode d'emploi / Instructions de montage	2
EN	Instructions for use / assembly instructions	3
IT	Istruzioni per l'uso / Istruzioni per Installazione	3
ES	Modo de empleo / Instrucciones de montaje	4
NL	Gebruiksaanwijzing / Handleiding	4
DK	Brugsanvisning / Monteringsvejledning	5
PT	Instruções para uso / Manual de Instalação	5
PL	Instrukcja obsługi / Instrukcja montażu	6
CS	Návod k použití / Montážní návod	6
SK	Návod na použitie / Montážny návod	7
ZH	用户手册 / 组装说明	7
RU	Руководство пользователя / Инструкция по монтажу	8
HU	Használati útmutató / Szerelési útmutató	8
FI	Käyttöohje / Asennusohje	9
SV	Brugsanvisning / Monteringsanvisning	9
LT	Vartotojo instrukcija / Montavimo instrukcijos	10
HR	Upute za uporabu / Uputstva za instalaciju	10
TR	Kullanım kılavuzu / Montaj kılavuzu	11
RO	Manual de utilizare / Instrucțiuni de montare	11
EL	Οδηγίες χρήσης / Οδηγία συναρμολόγησης	12
SL	Navodilo za uporabo / Navodila za montažo	12
ET	Kasutusjuhend / Paigaldusjuhend	13
LV	Lietošanas pamācība / Montāžas instrukcija	13
SR	Uputstvo za upotrebu / Uputstvo za montažu	14
NO	Brugsanvisning / Montasjeveiledning	14
BG	Инструкция за употреба / Ръководство за монтаж	15
SQ	Udhëzuesi i përdorimit / Udhëzime rreth montimit	15
AR	دليل الاستخدام / تعليمات التجميع	16

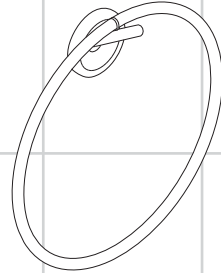

Starck
40821XXX

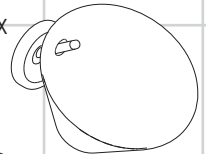

Starck
40833XXX



Starck
40834XXX



Starck
40837XXX

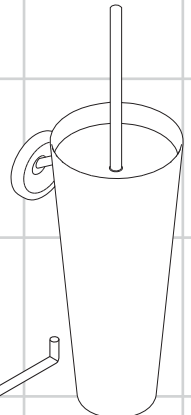

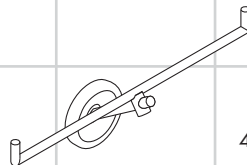

Starck
40835XXX



Starck
40836XXX



Sicherheitshinweise

-  Bei der Montage müssen zur Vermeidung von Quetsch- und Schnittverletzungen Handschuhe getragen werden.
-  Das Produkt darf nicht als Haltegriff benutzt werden. Es muss ein separater Haltegriff montiert werden.
-  Die ordnungsgemäße Befestigung und der feste Sitz der montierten Produkte ist in periodischen Abständen (jährlich) zu überprüfen.

Montagehinweise

Bei der Montage des Produktes durch qualifiziertes Fachpersonal ist darauf zu achten, dass die Befestigungsfläche im gesamten Bereich der Befestigung plan ist (keine vorstehenden Fugen oder Fliesenversatz), der Wandaufbau für eine Montage des Produktes geeignet ist und keine Schwachstellen aufweist. Die beigelegten Schrauben und Dübel sind nur für Beton geeignet. Bei anderen Wandaufbauten sind die Herstellerangaben des Dübelherstellers zu beachten.

Symbolerklärung



Kein essigsäurehaltiges Silikon verwenden!



Maße (siehe Seite 17)



Serviceteile (siehe Seite 20)



XXX = Farbcodierung
000 = chrom
820 = brushed nickel



Reinigung

siehe beiliegende Broschüre.

Consignes de sécurité

-  Lors du montage, porter des gants de protection pour éviter toute blessure par écrasement ou coupure.
-  Le produit ne doit pas servir de poignée. Monter pour cela une poignée séparée.
-  Vérifier à intervalles réguliers (une fois par an) la fixation correcte et la bonne assise des produits montés

Instructions pour le montage

Lors du montage du produit par un ouvrier qualifié, il faut faire attention à ce que la surface de fixation soit plane sur toute son étendue (aucun dépassement de joint ni de carrelage), que la construction de la paroi soit adaptée à l'installation du produit et surtout ne présente aucun point faible. Les vis et les chevilles fournies sont uniquement appropriées au béton. Pour les autres constructions, il faudra tenir compte des préconisations du fabricant de cheville.

Description du symbole



Ne pas utiliser de silicone contenant de l'acide acétique!



Dimensions (voir page 17)



Pièces détachées (voir page 20)

XXX = Couleurs
000 = chromé
820 = brushed nickel





Nettoyage

voir la brochure ci-jointe.





Safety Notes

-  Gloves should be worn during installation to prevent crushing and cutting injuries.
-  The product may not be used as a holding handle. A separate handle must be installed.
-  Check the proper attachment and tight seating of the installed products periodically (annually).

Installation Instructions

Where the contractor mounts the product, he should ensure that the entire area of the wall to which the mounting plate is to be fitted, is flat (no projecting joints or tiles sticking out), that the structure of the wall is suitable for the installation of the product and has no weak points. The enclosed screws and dowels are only suitable for concrete. For another wall constructions the manufacturer's indications of the dowel manufacturer have to be taken into account.

Symbol description



Do not use silicone containing acetic acid!



Dimensions (see page 17)



Spare parts (see page 20)



XXX = Colors
000 = chrome plated
820 = brushed nickel



Cleaning

see enclosed brochure.

Indicazioni sulla sicurezza

-  Durante il montaggio, per evitare ferite da schiacciamento e da taglio bisogna indossare guanti protettivi.
-  Il prodotto non deve essere utilizzato come maniglia, questa deve essere montata separatamente.
-  Il fissaggio a regola d'arte e la sede fissa dei prodotti montati va controllato a intervallo periodico (annualmente).

Istruzioni per il montaggio

Quando il personale tecnico specializzato esegue il montaggio del prodotto è necessario assicurarsi che la superficie di fissaggio sia piana in tutta l'area di fissaggio (senza giunti sporgenti o spostamento delle piastrelle), che la struttura della parete sia adatta per il montaggio del prodotto e soprattutto che non ci siano dei punti deboli. Le viti e i tasselli in dotazione sono adatti solo per calcestruzzo. In caso di altre strutture della parete vanno osservare le indicazioni del produttore dei tasselli.

Descrizione simbolo



Non utilizzare silicone contenente acido acetico!



Ingombri (vedi pagg. 17)



Parti di ricambio (vedi pagg. 20)

XXX = Trattamento
000 = cromato
820 = brushed nickel



Pulitura

vedi il prospetto accluso.



Assembly see page
18



Montaggio vedi
pagg. 18



Indicaciones de seguridad

-  Durante el montaje deben utilizarse guantes para evitar heridas por aplastamiento o corte.
-  El producto no debe ser utilizado como un elemento de sujeción. Debe montarse un elemento de sujeción separado.
-  Debe comprobarse en intervalos periódicos (anualmente) que los productos montados estén bien fijados y asentados.

Veiligheidsinstructies

-  Bij de montage moeten ter voorkoming van kniel- en snijwonden handschoenen worden gedragen.
-  Het product mag niet als handgreep worden gebruikt. Er moet een aparte handgreep gemonteerd worden.
-  De reglementaire bevestiging en de vaste zitting van de gemonteerde producten moet regelmatig (jaarlijks) gecontroleerd worden.

Indicaciones para el montaje

En el momento del montaje del producto por parte de personal especializado y cualificado se deberá prestar una atención especial a que la superficie de fijación en toda el área de la fijación sea plana (sin juntas que sobresalen ni azulejos desplazados), que la estructura de la pared sea adecuada para un montaje del producto y que, ante todo, no presente puntos débiles. Los tornillos y tacos adjuntos son sólo apropiados para hormigón. En el caso de otras estructuras murales se deberán considerar las indicaciones del fabricante de tacos.

Montage-instructies

Bij de montage van het produkt door een vakkundige installateur moet men erop letten dat het bevestigingsoppervlak op één oppervlak zit (dus geen opliggende voegen of verspringende tegels), de wand geschikt is voor montage van produkten en zeker geen zwakke plekken bevat. De bijgevoegde schroeven en duvels zijn alleen geschikt voor beton. Bei andere wandsoorten dient u te letten op de voorschriften van de fabrikant van de schroeven en duvels.

Descripción de símbolos



No utilizar silicona que contiene ácido acético!



Gebruik geen zuurhoudende silicone!



Dimensiones (ver página 17)



Maten (zie blz. 17)



Repuestos (ver página 20)

XXX = Acabados
000 = cromado
820 = brushed nickel



Service onderdelen (zie blz. 20)

XXX = Kleuren
000 = verchromd
820 = brushed nickel



Limpiar

ver el folleto adjunto.





Reinigen

zie bijgevoegde brochure.





Sikkerhedsanvisninger

-  Ved monteringen skal der bruges handsker for at undgå kvæstelser og snitsår.
-  Produktet må ikke bruges som håndtag. Der skal monteres et separat håndtag.
-  Den korrekte montering og position af monterede produkter skal kontrolleres i regelmæssige afstande (årligt).

Monteringsanvisninger

Ved montering er det vigtigt at sikre sig, at hele befæstigelsesfladen er plan (ingen ujævne fuger eller fliser), samt at væggen er egnet til montering af produktet og specielt, at væggen ikke har nogen svage punkter. De medfølgende skrue og dübler er kun egnet til beton. Ved anden vægopbygning bør producenten af dübler kontaktes for nærmere information.

Symbolbeskrivelse

 Der må ikke benyttes eddikesyreholdig silikone!



 **Målene** (se s. 17)

 **Reserve dele** (se s. 20)

XXX = Overflade
000 = Krom
820 = Brushed nickel

 **Rengøring**
se venligst den vedlagte brochure.

Avisos de segurança

-  Durante a montagem devem ser utilizadas luvas de protecção, de modo a evitar ferimentos resultantes de entalamentos e de cortes.
-  O produto não pode ser utilizado como pega de apoio. Tem que ser montada uma pega separada.
-  A fixação e encaixe correctos dos produtos montados devem ser verificados periodicamente (anualmente).

Avisos de montagem

Durante a montagem do produto por técnicos qualificados, deve ter-se em atenção que a superfície de fixação seja plana em toda a área da fixação (sem juntas sobrepostas/salientes ou ladrilhos deslocados), que o dispositivo de montagem na parede seja adequado para uma montagem na parede e que este não apresente nenhuns pontos fracos. Os parafusos e buchas incluídos no volume de fornecimento são apenas adequados para betão. Para outros métodos de montagem na parede devem ser respeitadas as indicações do fabricante das buchas.

Descrição do símbolo

 Não utilizar silicone que contenha ácido acético!

 **Medidas** (ver página 17)

 **Peças de substituição** (ver página 20)



XXX = Acabamentos
000 = cromado
820 = brushed nickel

 **Limpeza**
consultar a seguinte brochura.







Wskazówki bezpieczeństwa

-  Aby uniknąć zranień, takich jak zgniecenia czy przecięcia, podczas montażu należy nosić rękawice.
-  Produktu nie wolno używać jako uchwytu do trzymania się. Należy zamontować osobny uchwyt.
-  W określonym czasie (co roku) należy sprawdzać właściwe zamocowanie i odpowiednie osadzenie zamontowanych produktów.

Bezpečnostní pokyny

-  Pro zabránění řezným zraněním a pohmožděním je nutné při montáži nosit rukavice.
-  Produkt nesmí být používán jako madlo. Je nutné namontovat samostatné madlo.
-  Upevnění podle předpisů a pevné usazení montovaných produktů je třeba kontrolovat v periodických časových intervalech (ročně).

Wskazówki montażowe

Przy montażu produktu przez wykwalifikowany personel fachowy należy zważać na to, by powierzchnia mocowania na całym obszarze mocowania była równa (by nie było szczelin wzgl. wzajemnie przesuniętych płytek), rodzaj ściany nadawał się do montażu produktu i zwłaszcza, by nie było żadnych słabych stron. Umieszczone w dostawie śruby i kołki rozporowe są przeznaczone tylko do betonu. Przy innych rodzajach montażu ścianowego należy przestrzegać danych producenta kołków rozporowych.

Pokyny k montáži

Při montáži produktu kvalifikovaným odborným personálem je třeba dbát na to, aby upevňovací plochy byly v celém rozsahu upevnění rovné (žádné vyčnívající spáry nebo navzájem přesazené obklady), aby konstrukce stěny byla pro montáž produktu vhodná a zvláště aby v ní nebyla žádná slabá místa. Přiložené vruty a hmoždinky jsou vhodné pouze pro beton. Při jiných konstrukčních materiálech stěny je třeba se řídit údaji výrobce hmoždinek.

Opis symbolu

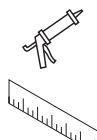

Nie stosować silikonów zawierających kwas octowy!

Wymiary (patrz strona 17)

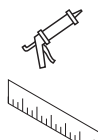

Nepoužívat silikon s obsahem kyseliny octové!

Rozmíry (viz strana 17)



Części serwisowe (patrz strona 20)

XXX = kody wykończenia powierzchni
000 = chrom
820 = nikiel szorowany



Czyszczenie

patrz dołączona broszura.



Servisní díly (viz strana 20)

XXX = kód povrchové úpravy
000 = chrom
820 = brushed nickel





Čištění

viz přiložená brožura.





Bezpečnostné pokyny

-  Pri montáži musíte nosiť rukavice, aby ste predišli pomliaždeninám a rezným poraneniam.
-  Výrobok sa nesmie používať ako držadlo. K tomu účelu sa musí namontovať samostatné držadlo.
-  Upevnenie podľa predpisov a pevné osadenie montovaných produktov treba kontrolovať v periodických časových intervaloch (ročne).

Pokyny pre montáž

Pri montáži produktu kvalifikovaným odborným personálom je nutné dbať na to, aby upevňovacie plochy boli v celom rozsahu upevnenia rovné (žiadne vyčnievajúce škáry alebo navzájom predsadené obklady), aby konštrukcia steny bola pre montáž produktu vhodná a zvlášť aby v nej neboli žiadne slabé miesta. Priložené vruty a hmoždiniky sú vhodné len pre betón. Pri iných konštrukčných materiáloch steny je nutné riadiť sa údajmi výrobcu hmoždiniek.

Popis symbolov

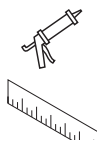

Nepoužívať silikón s obsahom kyseliny octovej!

Rozmery (viď strana 17)



Servisné diely (viď strana 20)



XXX = kód povrchovej úpravy
000 = chróm
820 = brushed nickel



Čištění

nájdete v priloženej brožúre.

安全技巧

-  装配时为避免挤压和切割受伤，必须戴上手套。
-  该产品不得作扶柄使用。必须安装单独的扶柄。
-  应定期（每年）检查已装配好的产品是否正常固定和固定定位。

安装提示

在安装产品的位置，安装人员必须确保安装面的墙面是平的（没有突出物或瓷砖没有突起），墙体结构适合产品的安装并没有弱点。包装内的膨胀螺丝只适用于混凝土墙体。对于其他墙体结构必须咨询膨胀螺丝生产商的建议。

符号说明

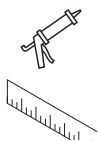

请勿使用含有乙酸的硅！

大小 (参见第 17 页)



备用零件 (参见第 20 页)

XXX = 颜色代码
000 = 镀铬
820 = 镍拉丝



清洗

附有小手册



**Montáž vid' strana
18**



安装 参见第 18 页



Указания по технике безопасности

-  Во время монтажа следует надеть перчатки во избежание прищемления и порезов.
-  Изделие запрещается использовать в качестве рукоятки. Следует устанавливать специальную рукоятку.
-  Надлежащее крепление и плотность посадки установленных изделий следует проверять регулярно (ежегодно).

Указания по монтажу

При монтаже изделия квалифицированным персоналом необходимо следить за тем, чтобы, поверхность крепления была плоской во всей зоне крепления (без выступающих швов или смещения плитки), структура стен подходила для монтажа изделия и, в частности, не имела слабых мест. Прилагаемые винты и дюбели предназначены только для бетона. При других типах стен необходимо соблюдать указания производителей дюбелей.

Описание символов

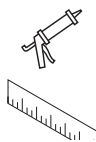

Не применяйте силикон, содержащий уксусную кислоту.

Размеры (см. стр. 17)



Комплект (см. стр. 20)



XXX = Код цвета поверхности
000 = хром
820 = brushed nickel



Очистка

см прилагаемая брошюра

Biztonsági utasítások

-  A szerelésnél a zúzódások és vágási sérülések elkerülése érdekében kesztyűt kell viselni.
-  A terméket nem szabad kapaszkodónak használni. Ehhez külön kapaszkodót kell felszerelni.
-  A felszerelt termékek szabályszerű rögzítését és szilárd elhelyezkedését rendszeres időközönként (évente) ellenőrizni kell.

Szerelési utasítások

Miközben szakképzett szakember végzi a termék felszerelését, ügyelni kell arra, hogy a rögzítési felületek a rögzítési terület teljes egészén síkok (nincsenek kiálló fugák vagy csempeszélek), a fal felépítése alkalmas a termék felszereléséhez, és különösképpen, hogy nincsenek benne gyenge pontok. A mellékelt csavarok és dübelek csak betonhoz alkalmasak. Egyéb falazatoknál figyelembe kell venni a dűbelgyártó gyártói utasításait.

Szimbólumok leírása

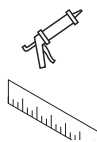

Ne használjon ecetsavtartalmú szilikon!

Méretet (lásd a 17. oldalon)



Tartozékok (lásd a 20. oldalon)

XXX = Színkódok
000 = króm
820 = brushed nickel





Tisztítás

lásd a mellékelt brosrút.





Turvallisuusohjeet

-  Asennuksessa on käytettävä käsineitä puristumien ja viiltojen aiheuttamien tapaturmien estämiseksi.
-  Tuotetta ei saa käyttää kädensijana. On asennettava erillinen kädensija.
-  Asennettujen tuotteiden asianmukainen kiinnitys ja tiukkuus on tarkastettava säännöllisin väliajoin (vuosittain).

Asennusohjeet

Kun pätevä ammattihenkilöstö suorittaa tuotteen asennusta, on huomioitava, että kiinnityspinta on koko kiinnityksen alueella tasainen (ei ulkonevia saumoja tai laattojen tasomuutoksia) ja, että seinän rakenne soveltuu tuotteen asentamiseen eikä siinä ole heikkoja kohtia. Mukana olevat kiinnitysruuvit ja kiinnitysankkurit soveltuvat betoniin kiinnittämiseen. Kiinnitettäessä tuotetta muihin seinärakenteisiin, noutata kiinnittimien valmistajan ohjeita.

Merkin kuvaus



Älä käytä etikahappopitoista silikoniala!

Mitat (katso sivu 17)



Varaosat (katso sivu 20)



XXX = Värikoodi
000 = kromi
820 = harjattu nikkeli



Puhdistus

katso oheinen esite

Säkerhetsanvisningar

-  Handskar ska bäras under monteringsarbetet så att man kan undvika kläm- och skärskadorgen werden.
-  Produkten får inte användas som handtag. Ett separat handtag måste monteras.
-  Alla monterade produkter ska kontrolleras regelbundet (varje år) så att de sitter fast ordentligt.

Monteringsanvisningar

När kvalificerad fackpersonal monterar produkten är det viktigt att tänka på att monteringsytan är plan i alla delar av arbetsytan (inga fogar som sticker ut eller klinkerförskjutningar), att väggkonstruktionen passar till montering av produkten samt att den inte har svaga punkter. Medföljande skruvar och plugg är endast avsedda för betong. Vid andra väggkonstruktioner skall anvisningarna från pluggtillverkaren beaktas.

Simbolio aprašymas



Använd inte silikon som innehåller ättiksyra!

Måtten (se sidan 17)



Reservdelar (se sidan 20)

XXX = Färgkodning
000 = krom
820 = borstad nickel



Rengöring

se den medföljande broschyren





Saugumo technikos nurodymai

- ⚠ Apsaugai nuo užspaudimo ir įsijovavimo montavimo metu mūvėkite pirštines.
- ⚠ Gaminy s neturi būti naudojamas kaip rankena. Rankena montuojama atskirai.
- ⚠ Gaminių pritvirtinimo teisingumą ir patikimumą būtina periodiškai (kasmet) tikrinti.

Sigurnosne upute

- ⚠ Prilikom montaže se radi sprječavanja prignječenja i posjekotina moraju nositi rukavice.
- ⚠ Proizvod ne smije služiti za pridržavanje. U tu se svrhu mora postaviti zaseban rukohvat.
- ⚠ U redovitim vremenskim razmacima (jednom godišnje) valja provjeravati propisnu pričvršćenost i stabilnost postavljenih proizvoda.

Montavimo instrukcija

Montuojant produktą, specialistas privalo įsitikinti, kad sienos plotas, prie kurio dedama montavimo plokštė, yra lygus (jokių plytelių ar kitų nelygumų), kad sienos struktūra yra pritaikyta produkto montavimui ir neturi jokių silpnų vietų. Pakuotėje esantys varžtai ir kaiščiai yra skirti tik betonui. Esant kitokiai sienai, varžtus ir kaiščius reikia rinktis pagal paskirtį.

Upute za montažu

Kada proizvod montira kvalificirano stručno osoblje treba paziti da čitava površina na koju se učvršćuje bude ravna (bez istaknutih fuga ili krivljenja pločica), da je zidna konstrukcija primjerena montaži proizvoda te osobito da nema slabih mjesta. Priloženi vijci i moždanici prikladni su samo za beton. Kod drugih zidnih nadgradnji treba obratiti pažnju na navode proizvođača moždanika.

Simbolio aprašymas



Nenaudokite silikono, kurio sudėtyje yra acto rūgšties!

Išmatavimai (žr. psl. 17)



Opis simbola



Nemojte koristiti silikon koji sadrži octenu kiselinu!

Mjere (pogledaj stranicu 17)



Atsarginės dalys (žr. psl. 20)

XXX = Spalva
000 = chrom
820 = brushed nickel

Valymas

žr. pridedamoje brošiūroje.



Rezervni djelovi (pogledaj stranicu 20)

XXX = Boje
000 = krom
820 = brushed nickel

Čišćenje

se u priloženoj brošuri.





! Güvenlik uyarıları

- ! Montaj esnasında ezilme ve kesilme gibi yaralanmaları önlemek için eldiven kullanılmalıdır.
- ! Ürün tutma kolu olarak kullanılmamalıdır. Aynı bir tutma kolu monte edilmelidir.
- ! Monte edilmiş ürünlerin talimatlara uygun sabitliği ve sıkı duruşu düzenli aralıklarla (yıllık) kontrol edilmelidir.

Montaj açıklamaları

Müteahhit, ürünü monteleyeceği yer, yani montaj plakasının monte edileceği duvar alanının tümü düz (herhangi bir eklem yerinin ya da duvar fayansının çıkıntısıyla) engellenmemiş, yapısı ürünü montelemeye uygun bir şekilde ve herhangi zayıf noktası olamamasını sağlamalıdır. Kaplı vidalar ve çubuklar sadece beton için uygundur. Başka duvar yapıları için, imalatçının çubuk imal edenin belirttiği hususlar dikkate alınmalıdır.

Simge açıklaması



Asetik asit içeren silikon kullanmayın!

Ölçüleri (Bakınız sayfa 17)



Yedek Parçalar (Bakınız sayfa 20)

XXX = Renkler
000 = krom
820 = brushed nickel



Temizleme

birlikte verilen broşür

! Instrucțiuni de siguranță

- ! La montare utilizați mânăși pentru evitarea contuziunilor și tăierii mâinilor.
- ! Nu este permisă utilizarea produsului pe post de mâner. este nevoie de montarea unui mâner corespunzător.
- ! Fixarea corespunzătoare și poziția fixă a produselor montate trebuie verificate la intervale regulate (anual).

Instrucțiuni de montare

La montarea produsului de către un personal calificat trebuie să fiți atenți ca suprafața, unde se fixează produsul să fie plată pe toată suprafața utilizată (să nu existe rosturi sau faianțe proeminente), peretele să fie adecvat pentru montarea produsului și să nu există zone de rezistență redusă. Șuruburile și diblurile livrate sunt potrivite pentru ziduri de beton. La alte tipuri de zid respectați instrucțiunile producătorului diblului utilizat.

Descrierea simbolurilor



Nu utilizați silicon cu conținut de acid acetic!



Dimensiuni (vezi pag. 17)



Piese de schimb (vezi pag. 20)

XXX = cod de culori
000 = crom
820 = nichel mat





Curățare

vezi broșura alăturată.





Υποδειξεις ασφαλείας

-  Για να αποφύγετε τραυματισμούς κατά τη συναρμολόγηση πρέπει να φοράτε γάντια.
-  Το προϊόν δεν επιτρέπεται να χρησιμοποιείται σαν λαβή στήριξης. Για τον σκοπό αυτό πρέπει να τοποθετηθεί ξεχωριστή λαβή στήριξης.
-  Θα πρέπει να ελέγχετε ανά διαστήματα (ετησίως) αν η στερέωση εξακολουθεί να είναι επαρκής και αν τα τοποθετημένα προϊόντα στηρίζονται καλά.

Οδηγίες συναρμολόγησης

Κατά τη συναρμολόγηση του προϊόντος από καθαρισμένο και εξειδικευμένο προσωπικό θα πρέπει να δοθεί προσοχή, ώστε η επιφάνεια στερέωσης στη συνολική περιοχή στερέωσης να είναι επίπεδη (να μην υπάρχουν προεξέχοντες αρμοί ή λιθογόμωση πλακιδίων), ώστε η κατασκευή του τοίχου να είναι κατάλληλη για τη συναρμολόγηση του προϊόντος και ώστε η επιφάνεια να μην παρουσιάζει αδύναμα σημεία. Οι συνημμένες βίδες και οι στυλίσκοι ενδείκνυνται μόνο για σκυρόδεμα. Σε άλλες επίτοιχες κατασκευές θα πρέπει να δοθεί προσοχή στα δεδομένα του Κατασκευαστή των στυλίσκων.

Περιγραφή συμβόλων



Μην χρησιμοποιείτε σιλικόνη που περιέχει οξικό οξύ!

Διαστάσεις (βλ. σελίδα 17)



Ανταλλακτικά (βλ. σελίδα 20)



XXX = Χρώματα
000 = Επιχρωμασμένα
820 = νικελ ματ



Καθαρισμός

βλ. συνημμένο φυλλάδιο

Varnostna opozorila

-  Pri montaži je treba nositi rokavice, da se preprečijo poškodbe zaradi zmečkanja ali urezov.
-  Proizvoda ne smete uporabljati kot držalnega ročaja. V ta namen je treba montirati poseben ročaj.
-  V periodičnih presledkih (letno) je treba preverjati pravilno pritrditev in trdnost naseda montiranih proizvodov.

Navodila za montažo

Kamorkoli bo pogodbjenik namestil izdelek, mora poskrbeti, da je celotno območje stene na katero bo plošča nameščena ravno (brez štrlečih fug ali robov ploščic), ter da je struktura stene primerna za namestitev in je brez šibkih točk. Priloženi vijaki in ležaji so primerni le za beton. Za ostale zidne konstrukcije je potrebno upoštevati proizvajalčeva navodila.

Opis simbola



Ne smete uporabiti silikona, ki vsebuje ocatno kislino!

Mere (glejte stran 17)



Rezervni deli (glejte stran 20)

XXX = Barve
000 = krom
820 = brushed nickel





Čiščenje

glejte priloženi brošuri.





Ohutusjuhised

-  Kandke paigaldamisel muljumis- ja löikevigastuste vältimiseks kindaid.
-  Toodet ei tohi kasutada käepidemena. Paigaldage eraldi käepide.
-  Monteeritud toote nõuetekohast paigaldust ja kinnitust tuleb korrapäraselt (kord aastas) kontrollida.

Paigaldamisjuhised

Toote paigaldamisel peab töövõtja tagama, et kogu seinapind, kuhu paigaldusplaat kinnitatakse, on lame (ükski vuuk ega keraamiline plaat ei ulatu esile), ning et seina konstruktsioon on toote paigaldamiseks sobiv ja sellel puuduvad nõrgad kohad. Kaasasolevad kruvid ja tüüblid sobivad üksnes betoonile. Muude seinakonstruktsioonide puhul tuleb arvesse võtta tüüblitootja esitatud tooteandmeid.

Sümbolite kirjeldus

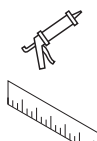

Ärge kasutage äädikhapet sisaldavat silikooni!

Mõõtude (vt lk 17)



Varuosad (vt lk 20)



XXX = Värvikood
000 = kroom
820 = brushed nickel



Puhastamine

vt kaasasolevast brošüürist.

Drošības norādes

-  Montāžas laikā, lai izvairītos no saspiedumiem un iegriezumiem, nepieciešams nēsāt cimdus.
-  Šo produktu nedrīkst izmantot kā roku balstu. Nepieciešams uzmontēt atsevišķu roku balstu.
-  Nepieciešams periodiski (reizi gadā) pārbaudīt, vai uzmontētie produkti ir pareizi piestiprināti un labi turas.

Norādījumi montāžai

Ja izstrādājuma montāžu veic kvalificēti speciālisti, jāseko, lai nostiprināšanas virsma visā nostiprināšanas zonā būtu gluda (šuves un flīzes nav izvirzītas uz āru), lai sienas konstrukcija būtu piemērota izstrādājuma montāžai un būtu pietiekami izturīga. Komplektā esošās skrūves un dībeļi ir paredzēti tikai šī izstrādājuma nostiprināšanai. Ja sienas konstrukcija ir citāda, jāievēro dībeļu ražotāja norādījumi.

Simbolu nozīme

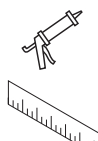

Neizmantot silikonu, kas satur etiķskābi!

Izmērus (skat. 17. lpp.)



Rezerves daļas (skat. 20. lpp.)

XXX = Krāsas
000 = hroma
820 = brushed nickel





Tīrīšana

skatiet pievienotajā brošūrā.







Sigurnosne napomene

-  Prilikom montaže se radi sprečavanja prignječenja i posekotina moraju nositi rukavice.
-  Proizvod se ne sme koristiti za kao ručka za pridržavanje. U tu svrhu se mora postaviti zaseban rukohvat.
-  Propisna pričvršćenost i stabilnost postavljenih proizvoda treba redovno da se proverava (jednom godišnje).

Sikkerheshenvisninger

-  Bruk hansker under montasjen for å unngå klem- og kuttskader.
-  Produktet skal ikke brukes som holdegrep. Det skal monteres en separat holdegrep.
-  De monterte produktene skal regelmessig sjekkes om de er ordentlig festet og om de sitter fast.

Instrukcije za montažu

Kada proizvod montira kvalifikovano stručno osoblje treba paziti da čitava površina na koju se učvršćuje bude ravna (bez istaknutih fuga ili krivljenja pločica), da je zidna konstrukcija primerena montaži proizvoda, i posebno da nema slabih mesta. Priloženi zavrtnji i tiplovi prikladni su samo za beton. Kod drugih zidnih nadgradnji treba obratiti pažnju na navode proizvođača tiplova.

Montagehenvisninger

Når kvalifisert fagfolk monterer produktet, skal man påse at hele området der produktet monteres er plant (ingen fremstående fuger eller flisekanter), at oppbygging av veggene er egnet for montasje av produktet og at veggene ikke viser noen svakpunkter. Medleverte skruer og pluggene egner seg kun for betong. Ved en annen veggoppbygging skal man ta hensyn til pluggprodusentens henvisninger.

Opis simbola

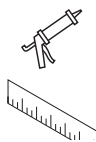

Nemojte koristiti silikon koji sadrži sirćetnu kiselinu!

Mere (vidi stranu 17)

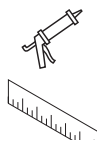

Ikke bruk silikon som inneholder eddiksyre!

Mål (se side 17)



Rezervni delovi (vidi stranu 20)

XXX = Oznake boja
000 = hrom
820 = brushed nickel



Serviceleder (se side 20)

XXX = Oznake boja
000 = hrom
820 = brushed nickel



Čišćenje

vidi priloženoj brošuri.



Rengjøring

se vedlagt brosjyre.



Montaža vidi stranu 18



Montasje se side 18



Указания за безопасност

-  При монтажа трябва да се носят ръкавици, за да се избегнат наранявания поради притискане или порязване.
-  Продуктът не бива да се използва като дръжка. Трябва да се монтира отделна дръжка.
-  Правилното закрепване и правилното разположение на монтираните продукти трябва да се проверява периодично (ежегодно).

Указания за монтаж

При монтаж на продукта от квалифицирани специалисти да се внимава за това, закрепващата повърхност в целия диапазон на закрепването да бъде равна (без изпъкнали фуги или изместване на плочки), конструкцията на стената да е подходяща за монтаж на продукта и особено за това, да няма слаби места. Приложените винтове и дюбели са подходящи само за бетон. При други стенни конструкции да се спазват данните на производителя на дюбели.

Описание на символите

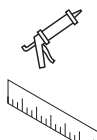

Не използвайте силикон, съдържащ оцетна киселина!

Размери (вижте стр. 17)



Сервизни части (вижте стр. 20)



XXX = Oznake boja
000 = hrom
820 = brushed nickel



Почистване

от приложената брошура.

Udhëzime sigurie

-  Për të evituar lëndimet e pickimeve ose të prerjeve gjatë procesit të montimit duhet që të vishni doreza.
-  Produkti nuk duhet të përdoret si dorëze mbajtëse. Duhet të montohet një dorëzë mbajtëse e veçantë
-  Montimi dhe pozicioni sipas rregullave i produkteve të montuara duhet verifikuar periodikisht (një herë në vit).

Udhëzime për montimin

Gjatë montimit të produktit nga ana e personit të kualifikuar duhet pasur parasysh që e gjithë sipërfaqja mbërthyesë të jetë e drejtë (nuk duhet të ketë hapësira mes pllakave). Mbi të gjitha muri duhet të jetë i përshtatshëm për montim dhe nuk duhet të ketë pika të dobëta. Vidhat dhe kunjat e bashkangjitura janë të përshtatshme vetëm për beton. Te përbërja tjetër murore të merren parasysh të dhënat e prodhuesit të kunjave.

Përshkrimi i simbolit

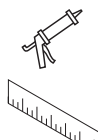

Mos përdorni silikon që në përbërje ka acid acetik.

Përmasat (shih faqen 17)



Pjesët e servisit (shih faqen 20)

XXX = Oznake boja
000 = hrom
820 = brushed nickel



Pastrimi

shikoni broshurën bashkëngjitur.

Монтаж вижте стр. 18  **Montimi shih faqen 18**



⚠️ تنبيهات الأمان

- ⚠️ يجب إرتداء قفازات لليد أثناء التركيب لتجنب حدوث أخطار الإنحشار أو الجروح.
- ⚠️ ممنوع إستخدام المنتج كمقبض. يجب تركيب مقبض منفصل.
- ⚠️ يتعين التأكد من أن حالة التثبيت مطابقة للشروط المحددة والتأكد من الوضع الثابت للمنتجات المركبة على فترات منتظمة (سنويا)

تعليمات التركيب

يجب الانتباه عند تركيب المنتج بواسطة فريق العمل المتخصص إلى أن جميع مواضع التثبيت جاهزة للتثبيت دون عوائق (خالية من المفصلات أو المصقات)، وأن الحائط جاهز لتركيب المنتج مع عدم احتوائه على أية أماكن ضعيفة. مبيئات المسامير (الفيشر) والمسامير نفسها مناسبة للحوائط الخرسانية فقط، ويجب الالتزام بتعليمات الجهة المصنعة لمبيئات المسامير عند التثبيت في أنواع أخرى من الحوائط.

وصف الرمز

هام! لا تستخدم السليكون الذي يحتوي على أحماض!



أبعاد (راجع صفحة 17)

قد يسبب البخار المتراكم على القطع تغييراً في الأبعاد الحقيقية، ولذلك فإنه لا يلزم المطابقة بتوصيلحات.

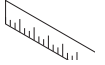

قطع الغيار (راجع صفحة 20)

XXX = الألوان
000 = كروم
820 = نيكل مُقرّش

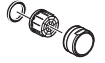

التنظيف

راجع والكتيب المرفق.



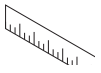

Starck 40821XXX

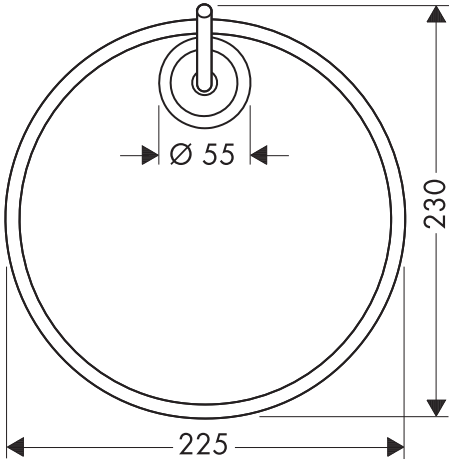

Starck 40833XXX

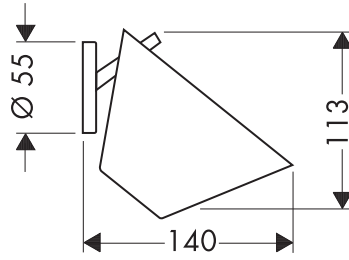

Starck 40835XXX

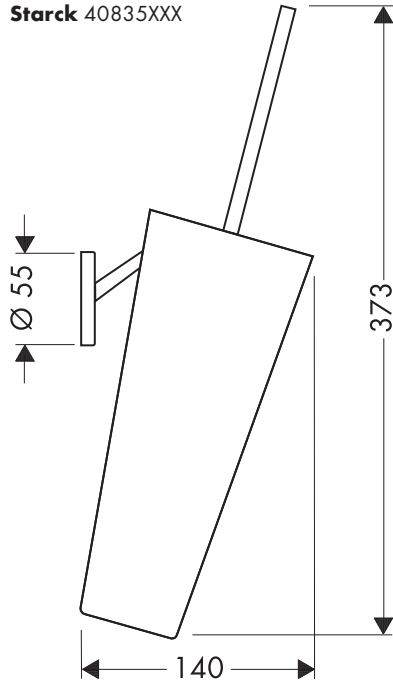

Starck 40834XXX

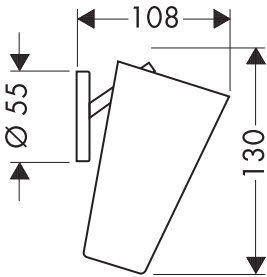

Starck 40836XXX

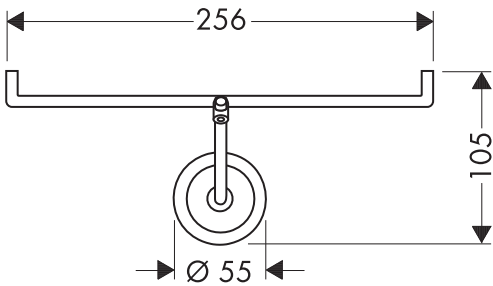

Starck 40837XXX

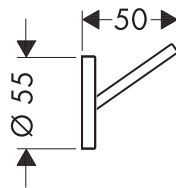

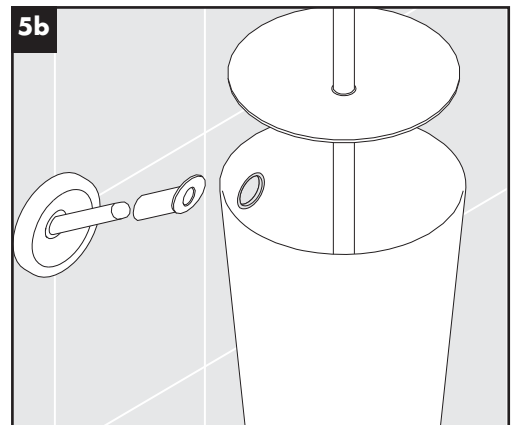
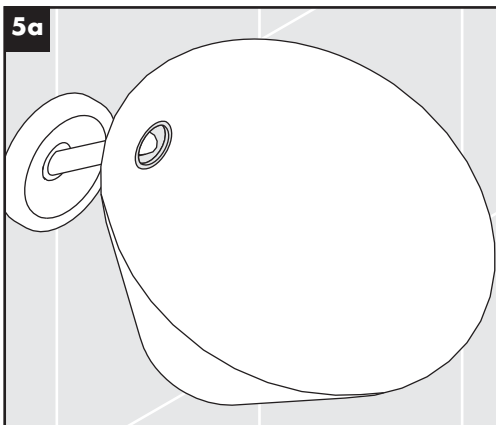
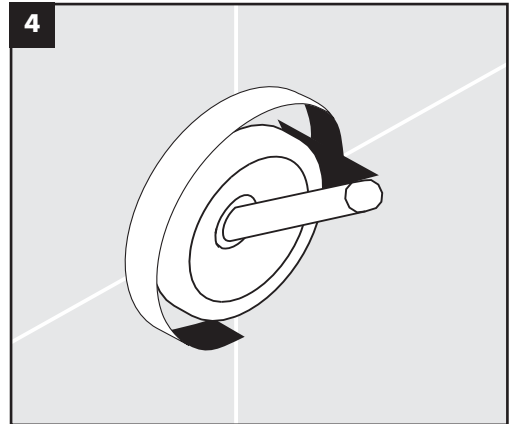
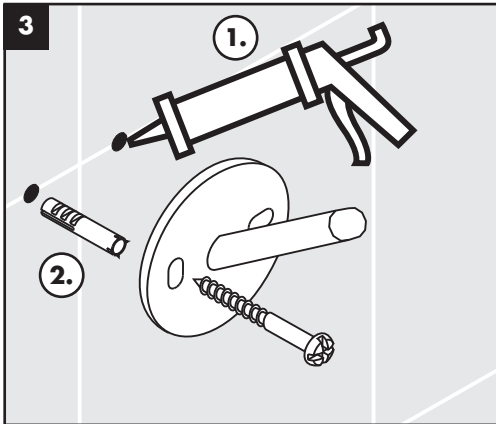
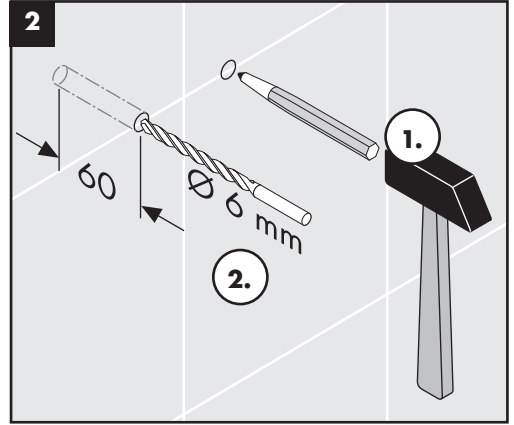
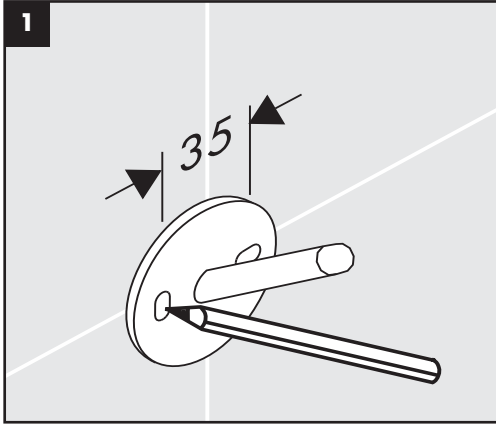

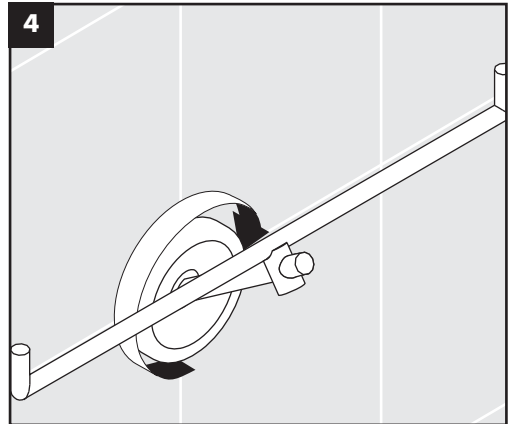
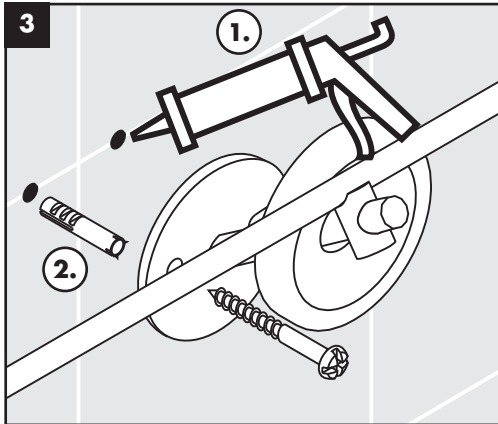
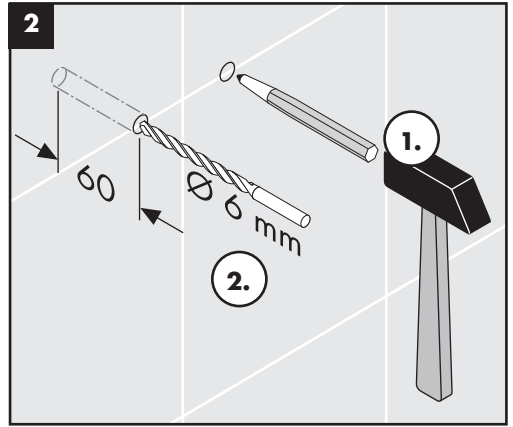
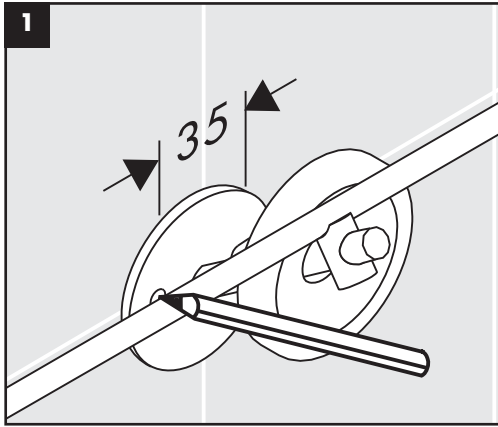

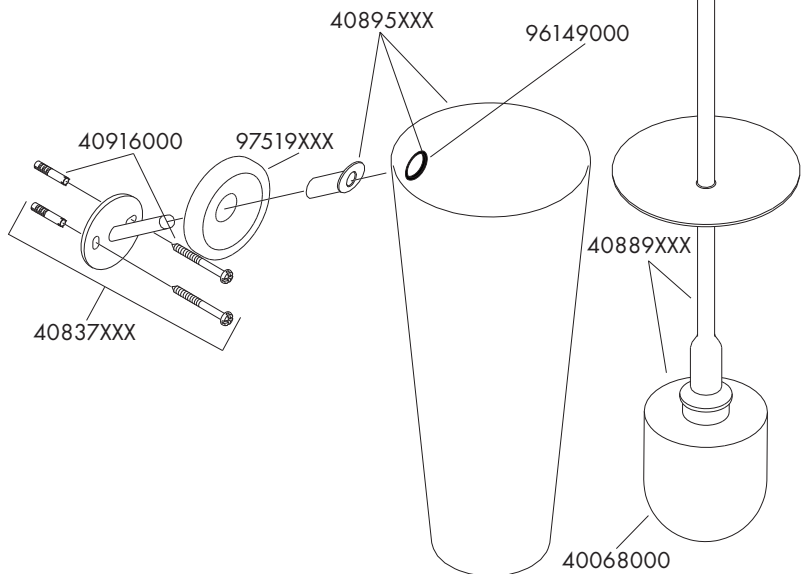
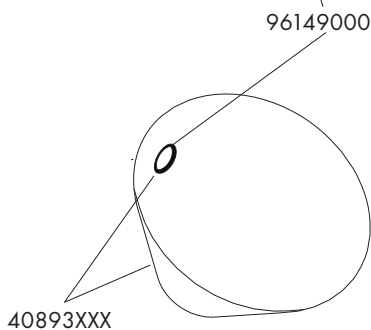
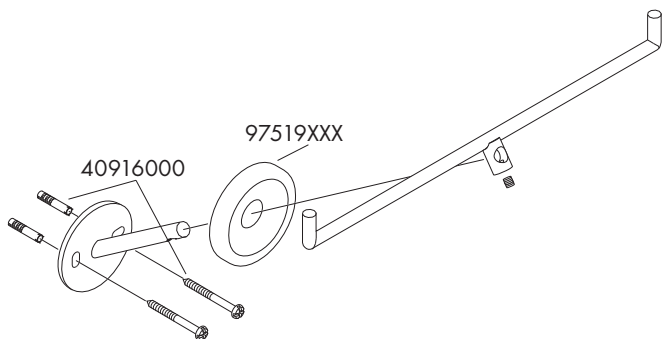
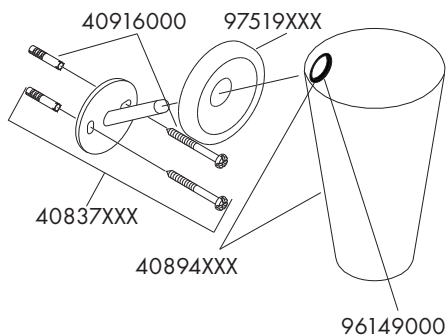
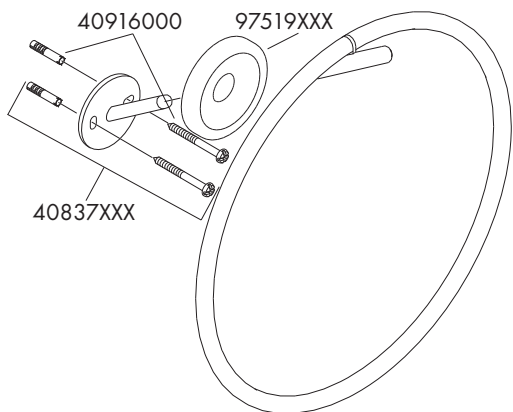

hansgrohe