

Installation

Tools

- Adjustable wrench
- Groove joint plier
- Pipe tape
- Phillips screwdriver

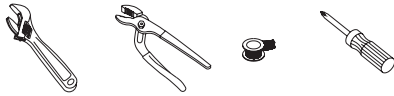

For Models: N600 01

Maintenance

Your new laundry/bar faucet is designed for years of trouble-free performance. Keep it looking new by cleaning it periodically with a soft cloth. Avoid abrasive cleaners, steel wool and harsh chemicals as these will dull the finish and void your warranty.

Safety Tips

- If you use soldering for the installation of the faucet, the seats, cartridges and washers will have to be removed before using flame. Otherwise, warranty will be void on these parts.
- Protect your eyes with safety glasses when cutting or soldering water supply line.
- Cover your drain to avoid losing parts.

Important Points

Prior to beginning installation, turn off the cold and hot water lines and open the old faucet to release built-up pressure. When installing your new faucet, turn the connector nuts finger-tight, then use one wrench to anchor the fitting and a second wrench to tighten the nut one additional turn. Connections that are too tight will reduce the integrity of the system. Wrap all threaded connections with Teflon tape available at your local hardware or plumbing supply store. Always wrap in a clockwise direction. The fittings should be installed by the State-licensed plumber.

Things You May Need

All installations can vary depending on how your previous faucet was installed. Necessary supplies to install your faucet are not all included; however, they are available wherever plumbing supplies are sold. When choosing your installation supplies, make sure they are IAPMO and/or CSA approved products.

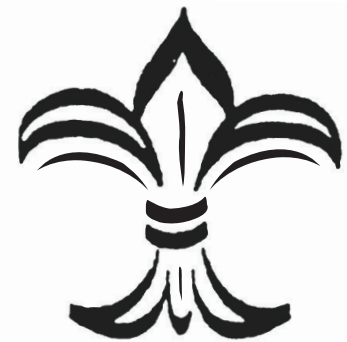

Belle Forêt
collection

Preparation/Assembly

1 Shut off main water supply before installation.

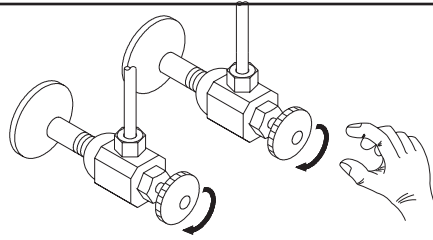

2 Place new faucet in position on sink. From under sink, thread nuts onto faucet. Tighten nuts.

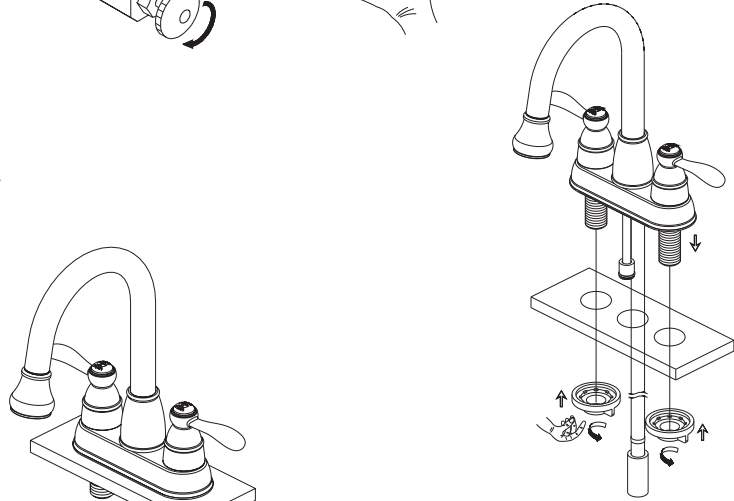

3 Loosen screw on hose adapter at the end of flex hose, push adapter with hose coupling until you hear a "click". Tighten with screw.

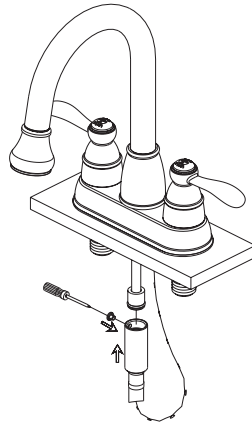

4 Attach weights set to hose. For best results, be sure the spray head is locked in the faucet body, and attached the weights just above the lowest part of the hose as it rises to the spout. This will ensure pulling force all the way into the faucet body.

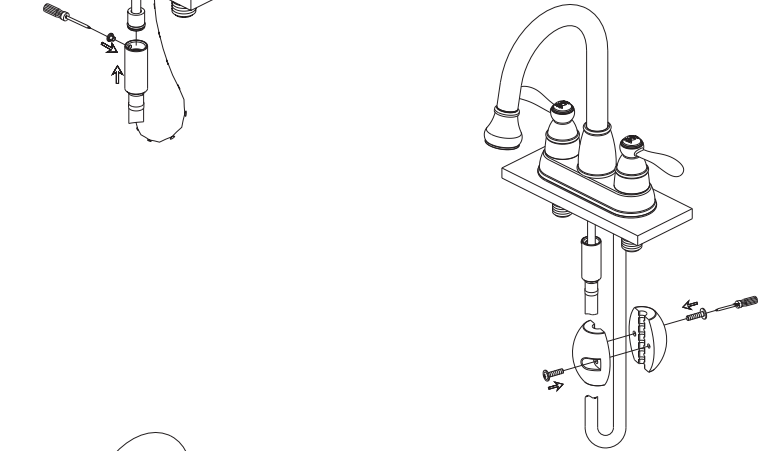

5 Wrap supply inlets with pipe tape and connect to water supply.

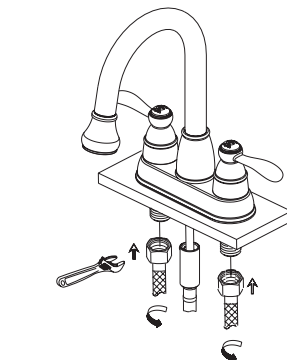
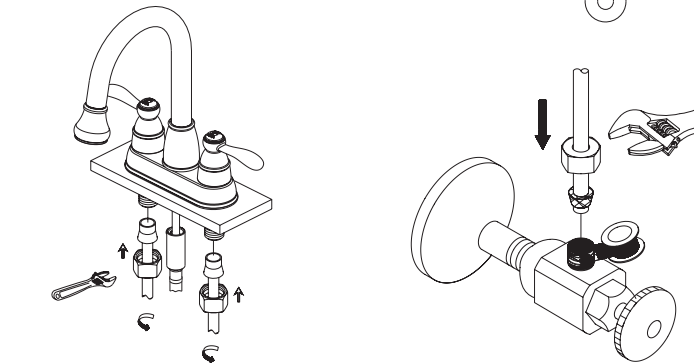

Installation

6 After installing faucet, remove pull-down spray and turn on water to remove any leftover debris. Re-assemble spray. Please Note:

- A. This pull-down faucet features two modes of operation. Aeration mode and spray mode (see illustration). To switch to spray mode, Clockwise rotate spray head 90°.
- B. This pull-down faucet also features a laundry mode. Remove pull-down spray, assemble the adapter assembly provided and connect to the washer machine.

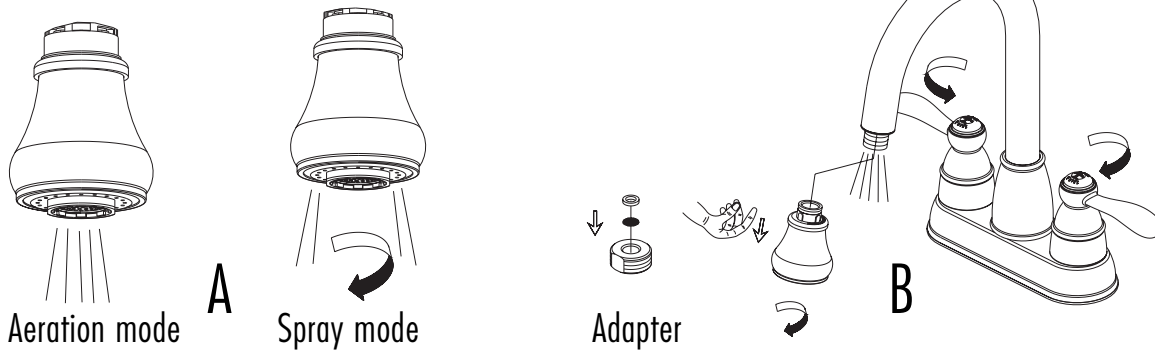

Steps 7

Parts Breakdown

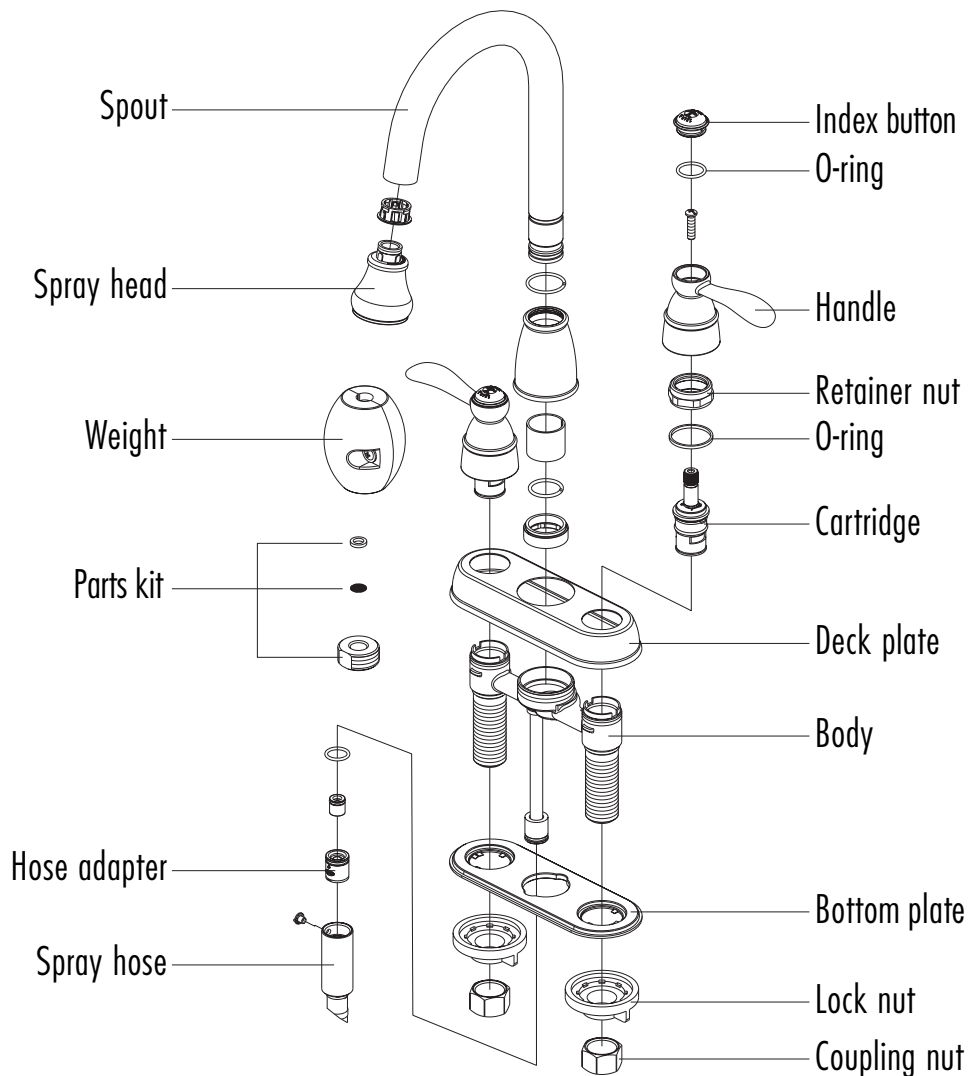

Parts Diagram