

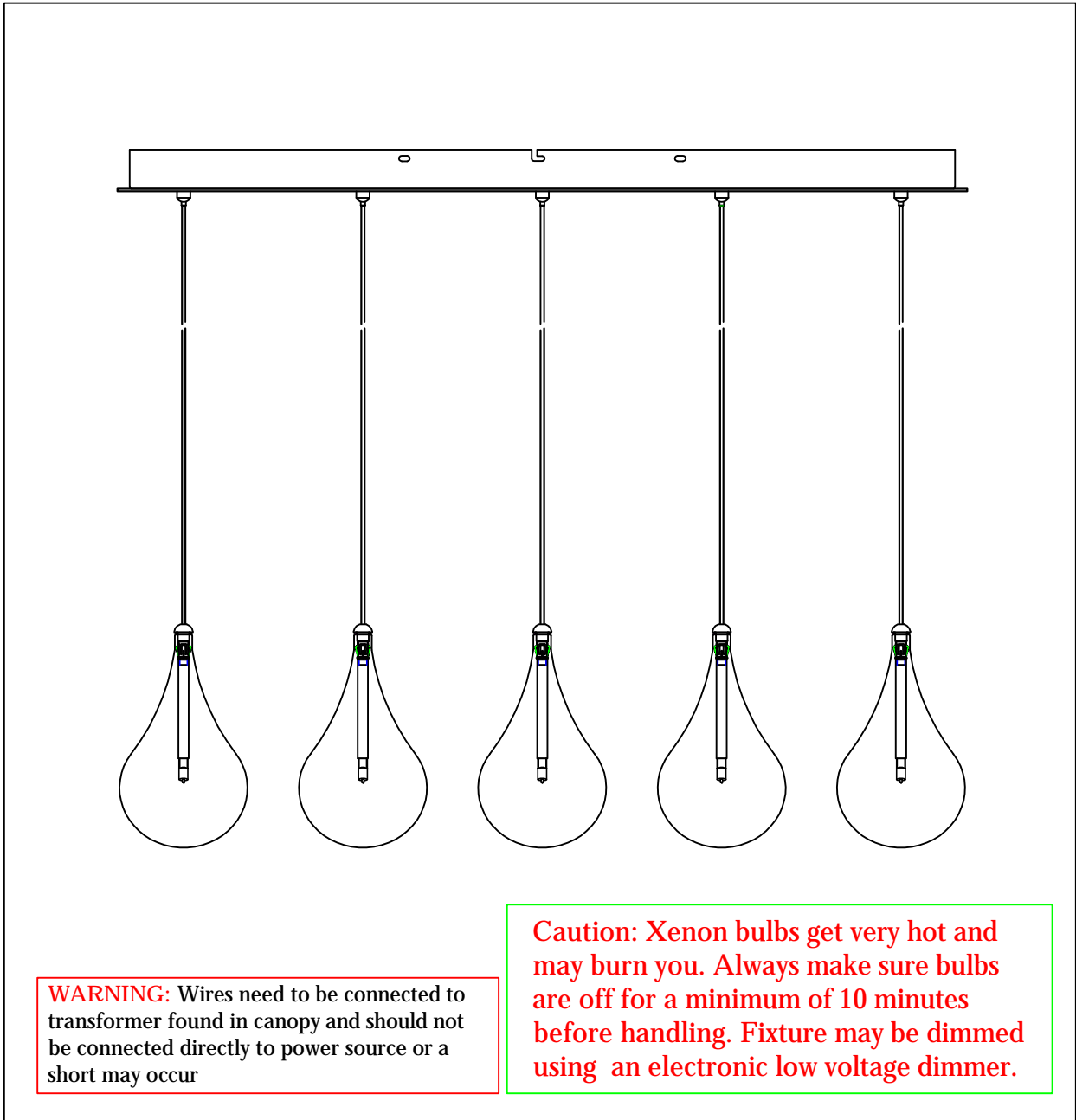

Contemporary Lighting

PRODUCT NAME: LARMES
ITEM NUMBER: E23115-18

Please consult your electrician for hanging fixture and wiring.



Bulbs (Included): 5 x 20 Watt G4

PRODUCTS ARE NOT INENDED
FOR COMMERCIAL USE

MADE IN CHINA
Page 1 of (2)

IMPORTANT: Turn off the power at the main fuse or circuit breaker box before starting installation

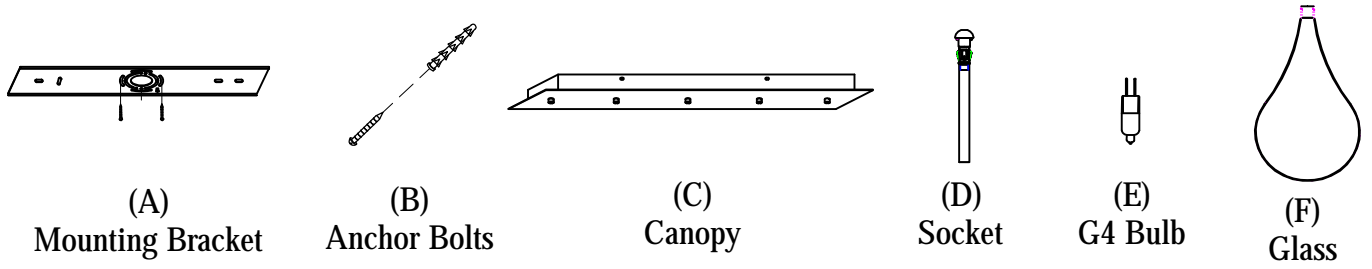

Locate all hardware & components before discarding packaging

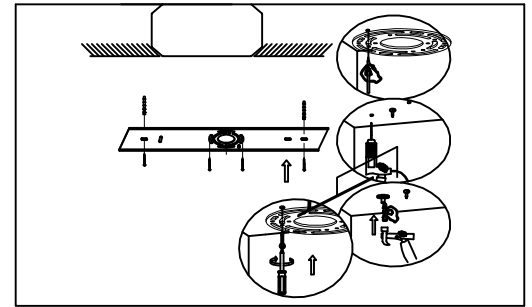
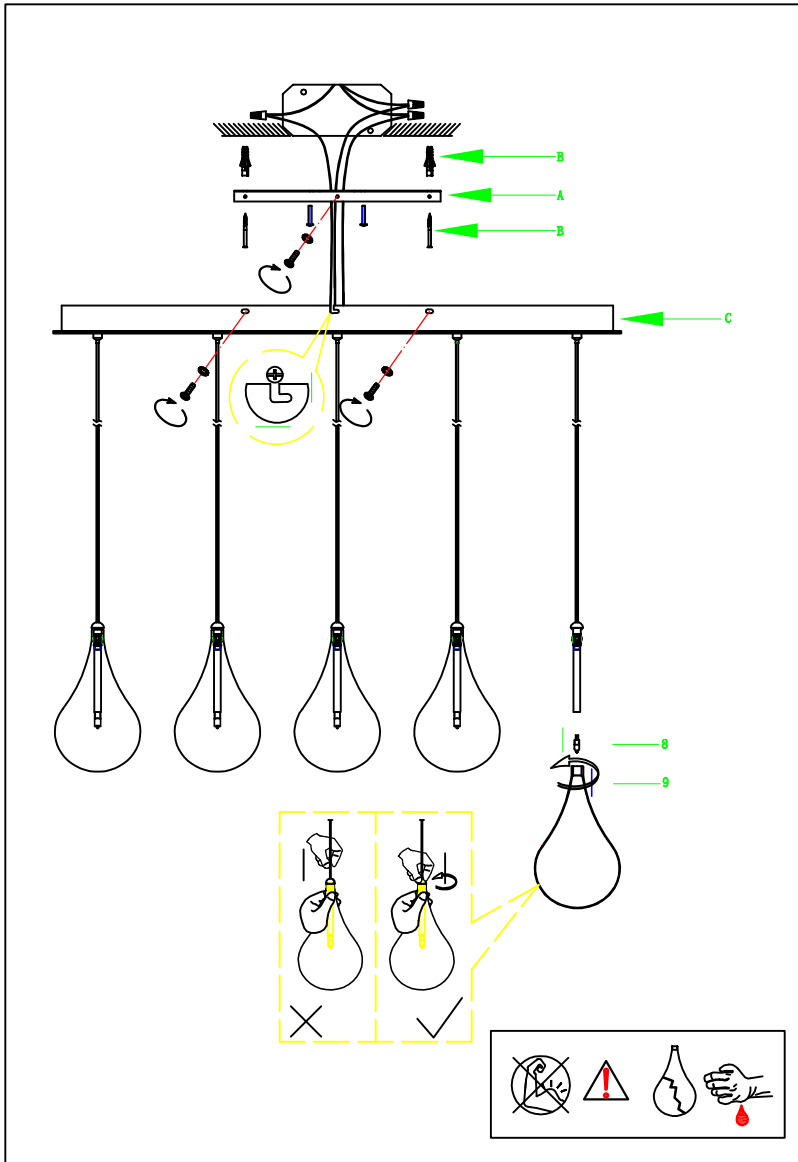

1.)

Step.1: Remove mounting bracket (A) and install to electrical box. Mark where anchors meet ceiling, remove mounting bracket from ceiling, and then drill holes using 3/16" drill bit where marked (B). Install mounting bracket and attach anchors to secure bracket at ends.

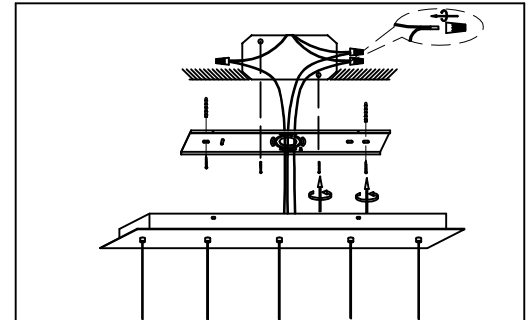

2.)

Step.2: Wire fixture to wires in outlet box. Green wire is for Ground.

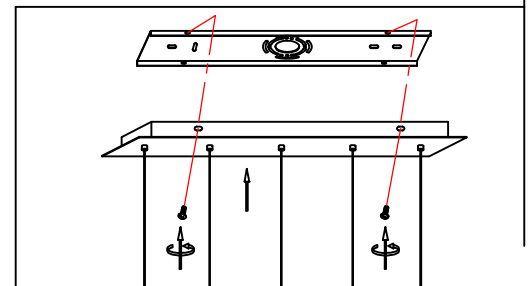

3.)

Step.3: Tighten screws (D) on the sides of the canopy (C) to secure the fixture.

4.)

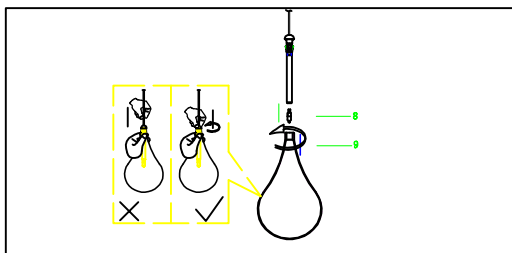

Step.4: Install G9 bulb (E) provided. Gently turn glass (F) onto socket (D) to secure.

Cleaning & Care:

Clean with soft cloth and a mild detergent. Do not use abrasive cleaner.