



Features

- End drain.
- Slotted overflow for deep soaking.
- Integral lumbar support and armrests for comfort.
- Coordinates with other products in the Archer® collection.
- 66" (1676 mm) x 32" (813 mm) x 19" (483 mm)

Material

- Acrylic

Installation

- Drop-in

Required Accessories

K-7271 Brass Slotted Overflow Bath Drain

or

K-7272 PVC Slotted Overflow Bath Drain

Recommended Accessories

K-24916 Wireless Music Kit



ADA

Codes/Standards

CSA B45.5/IAPMO Z124

Greenguard UL 2818 - Gold

ADA











ICC/ANSI A117.1

KOHLER® One-Year Limited Warranty

See website for detailed warranty information.

Available Color/Finishes

Color tiles intended for reference only.

Color	Code	Description
	0	White
	96	Biscuit
	47	Almond
	NY	Dune
	95	Ice™ Grey
	G9	Sandbar
	33	Mexican Sand™
	K4	Cashmere
	58	Thunder™ Grey
	7	Black Black™

No change in measurements if connected with drain illustrated. (K-7272)

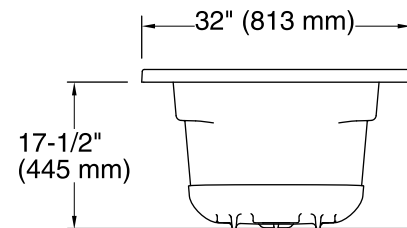
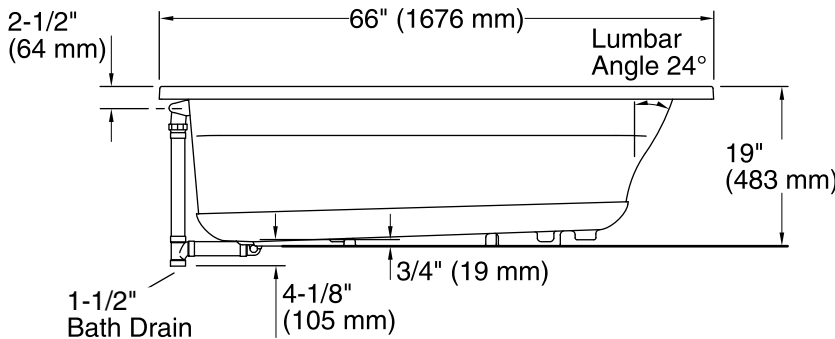
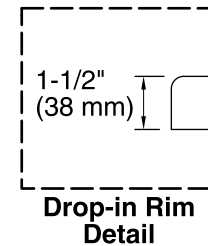
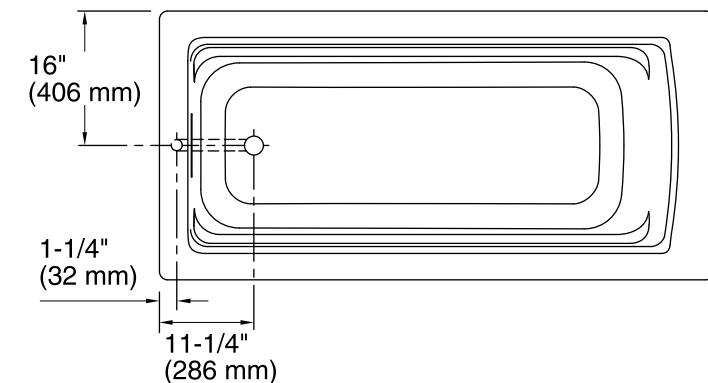

Technical Information

All product dimensions are nominal.

Installation:	Drop-in
Drain location:	End
Basin area, bottom:	50-3/8" x 19-5/8" (1280 mm x 498 mm)
Basin area, top:	57-5/16" x 24-1/16" (1456 mm x 611 mm)
Weight:	66 lbs (29.9 kg)
Minimum floor load:	44 lbs/ft ² (214.8 kg/m ²)
Water depth:	15-5/16" (389 mm)
Water capacity:	66 gal (249.8 L)
Cutout:	Drop-in, 64-1/2" x 30-1/2" (1638 mm x 775 mm)
Minimum flat for door:	2-3/16" (55 mm)

Notes

Measure your actual product for rough-in details.

Install this product according to the installation instructions.

The hot water supply should be 70% of the capacity of the bath or greater. Installations will vary.

This product is designed for drop-in installation only. It is not suited for use in a three-wall alcove with an overhead shower.

ADA compliant when installed to the specific requirements of these regulations.