

Features

- Integral flange.
- Left drain.
- Slotted overflow for deep soaking.
- Integral lumbar support.
- Integral apron.
- Above-the-floor drain installation.
- Textured bottom surface.
- 60" (1524 mm) x 32" (813 mm) x 21" (533 mm).

Material

- Acrylic.

Installation

- Alcove.

Required Accessories

- K-7271 Brass Slotted Overflow Bath Drain
- K-7272 PVC Slotted Overflow Bath Drain



Codes/Standards











- CSA B45.5/IAPMO Z124
- ASTM E162
- ASTM E662
- CARB P2

KOHLER® One-Year Limited Warranty

See website for detailed warranty information.

Available Color/Finishes

Color tiles intended for reference only.

Color	Code	Description
	0	White
	96	Biscuit
	47	Almond
	NY	Dune
	95	Ice™ Grey
	G9	Sandbar
	33	Mexican Sand™
	K4	Cashmere
	58	Thunder™ Grey
	7	Black Black™

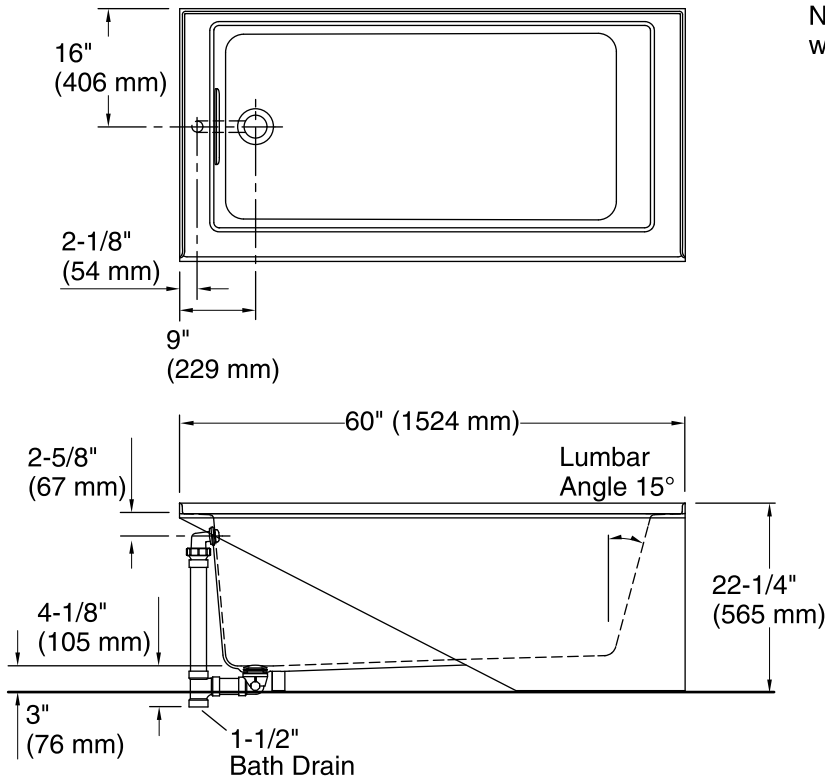

No change in measurements if connected with drain illustrated. (K-7272)

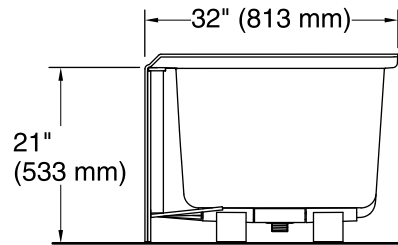
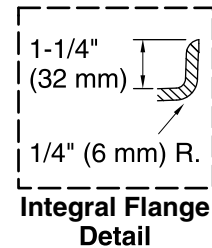

Technical Information

All product dimensions are nominal.

Installation:	3-Wall Alcove
Drain location:	Left
Basin area, bottom:	46-1/4" x 22" (1175 mm x 559 mm)
Basin area, top:	52" x 24" (1321 mm x 610 mm)
Weight:	105 lbs (47.6 kg)
Minimum floor load:	56 lbs/ft ² (273.4 kg/m ²)
Water depth:	15-1/2" (394 mm)
Water capacity:	68 gal (257.4 L)
Minimum flat for door:	2-3/4" (70 mm)

Notes

Measure your actual product for rough-in details.

Install this product according to the installation instructions.

The hot water supply should be 70% of the capacity of the bath or greater. Installations will vary.