



Cimarron®
 Comfort Height® Toilet
K-3589-T

Features

- Elongated bowl.
- 1.6 gpf (6.1 lpf).
- With tank cover locks.
- Right-hand trip lever.
- 2-1/8" (54 mm) glazed trapway.
- 28-3/4" (730 mm) x 17-5/8" (447 mm) x 30-3/4" (781 mm).

Material

- Vitreous china.

Technology

- AquaPiston® flushing system.

Required Accessories

K-4636 Toilet Seat

or

ADA

K-4650 Toilet Seat

K-4650-A Toilet Seat

Recommended Accessories

K-7637 Angle Supply with Stop (single)

Components

Product includes:

K-4309 Elongated Toilet Bowl

K-4418 Toilet Tank

Additional included component/s: Tank cover, Trip lever, Tank accessory pack, and Bolt cap accessory pack.



ADA	CSA B651	OBC
-----	----------	-----

Codes/Standards

ASME A112.19.2/CSA B45.1

ADA

ICC/ANSI A117.1

CSA B651







OBC

KOHLER® One-Year Limited Warranty

See website for detailed warranty information.

Available Color/Finishes

Color tiles intended for reference only.

Color	Code	Description
	0	White
	96	Biscuit
	47	Almond
	NY	Dune
	95	Ice™ Grey
	G9	Sandbar
	7	Black Black™

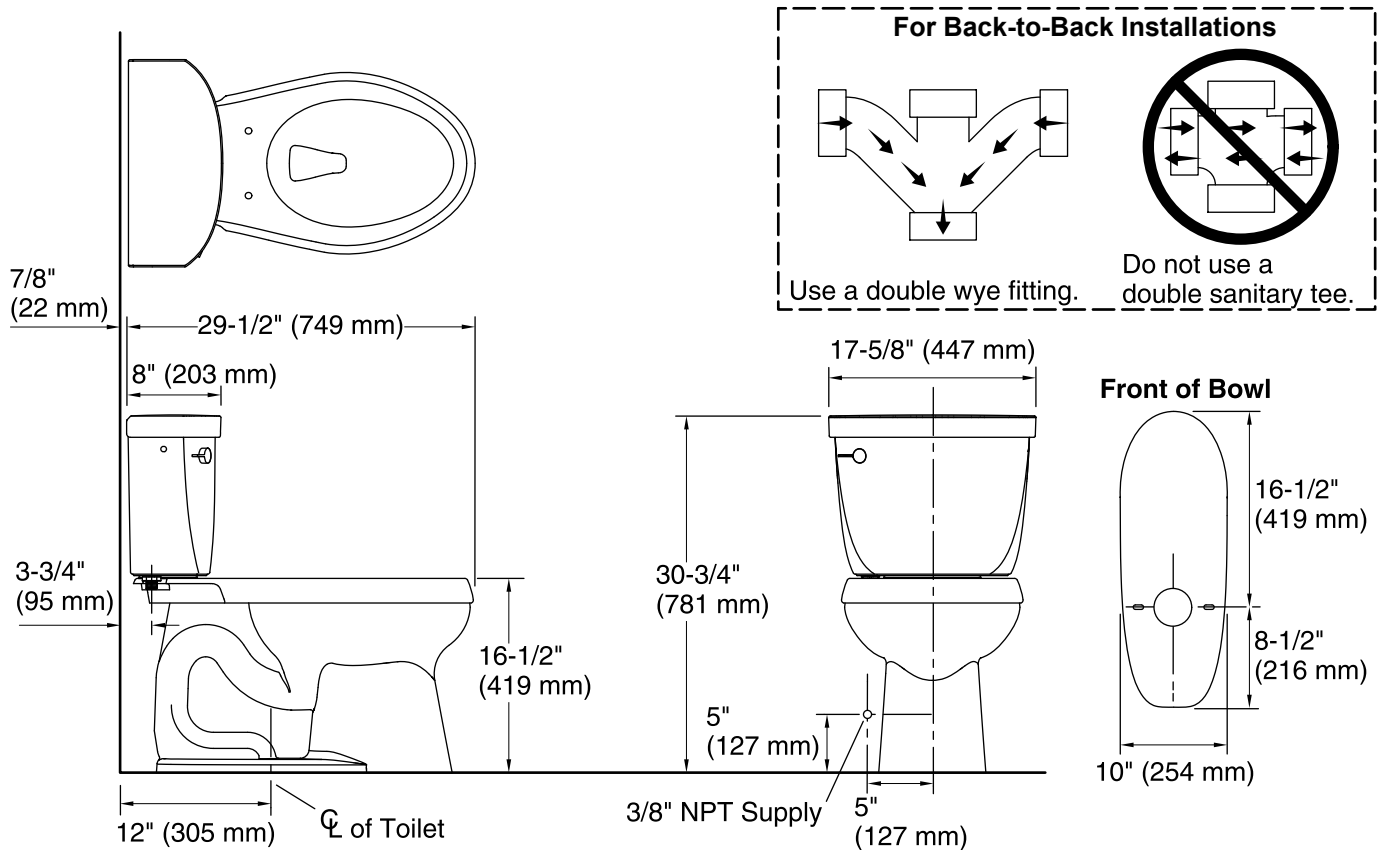

Technical Information

All product dimensions are nominal.

Toilet type:	Two-piece, Floor-mount
Bowl shape:	Elongated front
Flush type:	AquaPiston
Trap passageway:	2-1/8" (54 mm)
Water Consumption	
Full:	1.6 gpf (6 lpf)
Water surface size:	10-1/2" x 7-1/8" (267 mm x 181 mm)
Rim to water surface:	6-1/8" (156 mm)
Rough-in:	12" (305 mm)
Seat-mounting holes:	5-1/2" (140 mm)

Notes

Install this product according to the installation instructions.

For back-to-back toilet installations: Use only a 45 degree double wye fitting.

ADA, OBC, CSA B651 compliant when installed to the specific requirements of these regulations.

Plumbing Codes require elongated toilets and elongated, open-front toilet seats in public bathrooms.

Accessibility standards require controls to be located on the open side of the toilet.