

Features

- One-piece toilets integrate the tank and bowl into a seamless, easy-to-clean design.
- Elongated bowl offers added room and comfort.
- Comfort Height® feature offers chair-height seating that makes sitting down and standing up easier for most adults.
- 1.28 gallons per flush (gpf).
- 2-1/8-inch glazed trapway.
- Standard left-hand Polished Chrome trip lever included.
- Supply line not included.
- Coordinates with other products in the Cimarron collection.
- Flush valve's 3: 2 ratio harnesses the natural force of gravity and optimizes flush performance

Technology

- Durable canister design has 90% less exposed seal material than a 3-inch flapper, for leak-free performance.
- Single-flush gravity uses the force of gravity and a precision-engineered tank, bowl, and trapway to create a strong siphon during flushing.
- AquaPiston canister allows water to flow into the bowl from all sides (360 degrees), increasing the power and effectiveness of the flush.
- Flush valve's 3: 2 ratio harnesses the natural force of gravity and optimizes flush performance.
- Durable canister design has 90% less exposed seal material than a 3-inch flapper, for leak-free performance.
- Light-touch canister flush requires a lower actuation force than a flapper.

Installation

- Standard 12-inch rough-in.

Water Conservation & Rebates

- WaterSense® toilets meet strict EPA flushing guidelines, including using at least 20 percent less water than 1.6-gallon toilets.
- Eligible for consumer rebates in some municipalities.

Recommended Accessories

K- 7637 Angle Supply with Stop (single)

Optional Accessories

K- 4650 Toilet Seat

K- 4732 Toilet Seat

K- 9466-L Left-hand Trip Lever



ADA **CSA B651** **OBC**

Codes/Standards

ASME A112.19.2/CSA B45.1

EPA WaterSense®

ADA

ICC/ANSI A117.1

CSA B651











OBC

KOHLER® One-Year Limited Warranty

See website for detailed warranty information.

Available Color/Finishes

Color tiles intended for reference only.

Color	Code	Description
	0	White
	96	Biscuit
	47	Almond
	NY	Dune
	95	Ice™ Grey
	G9	Sandbar
	33	Mexican Sand™
	K4	Cashmere
	58	Thunder™ Grey
	7	Black Black™

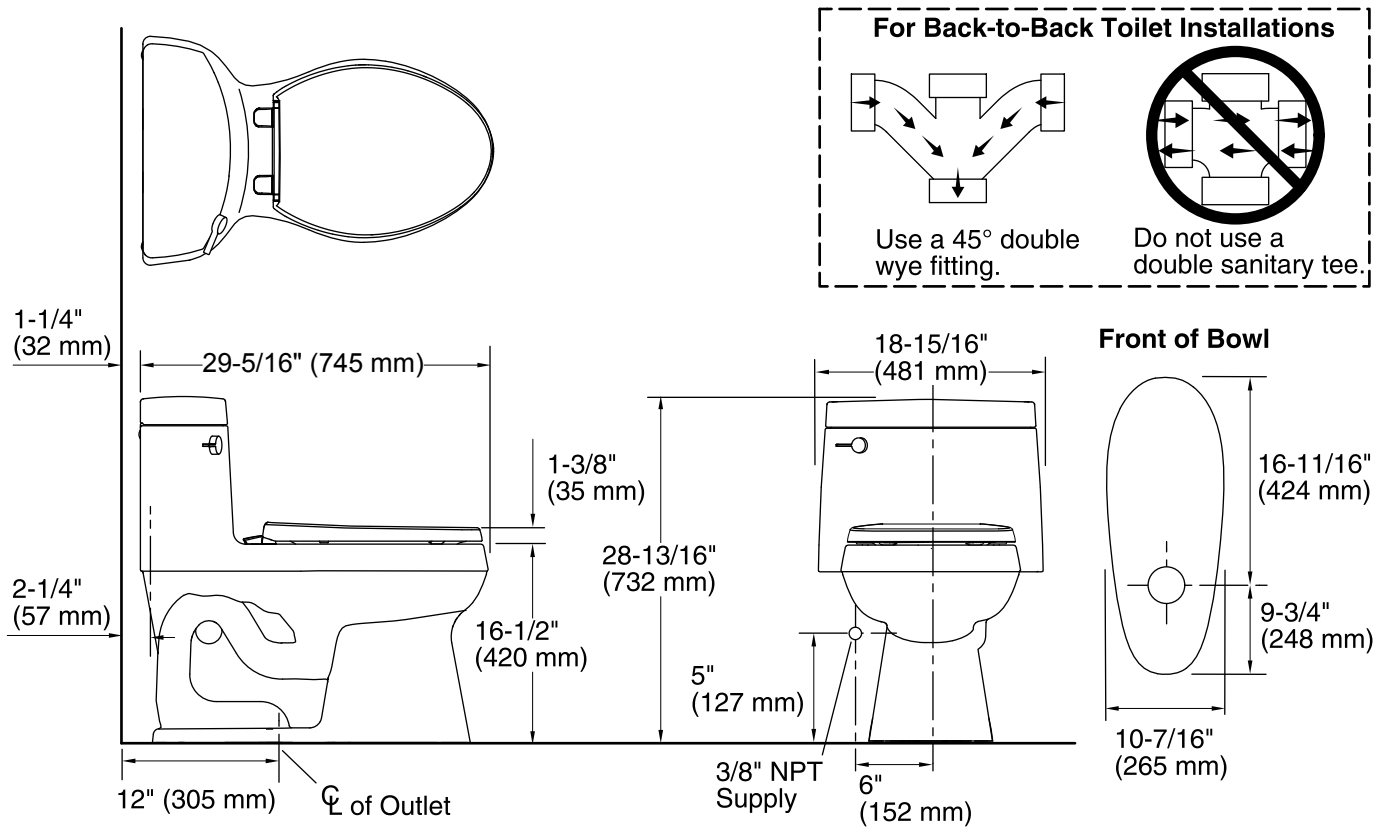

Technical Information

All product dimensions are nominal.

Toilet type:	One-piece
Bowl shape:	Elongated front
Flush type:	Other
Seat hinge type:	Quick-Attach®, Quiet-Close™, Quick-Release™
Trap passageway:	2-1/8" (54 mm)
Water Consumption	
Full:	1.28 gpf (4.8 lpf)
Water surface size:	11-3/4" x 8" (298 mm x 203 mm)
Rim to water surface:	6-1/8" (156 mm)
Rough-in:	12" (305 mm)
Seat-mounting holes:	5-1/2" (140 mm)

Notes

Install this product according to the installation guide.

For back-to-back toilet installations: Use only a 45° double wye fitting.

The Model Plumbing Codes require the installation of elongated open-front toilet seats in public bathrooms.

ADA, OBC, CSA B651 compliant when installed to the specific requirements of these regulations.

The Model Plumbing Codes require the installation of elongated open-front toilet seats on public bathrooms.