









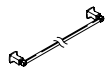
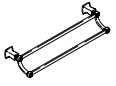

Features

- Metal construction
- Includes installation hardware
- Complements the Margaux Suite

Colors/Finishes

- CP: Polished Chrome
- Other: Refer to Price Book for additional colors/finishes

Specified Model

Model	Description		Colors/Finishes	
K-16250	18" (45.7 cm) towel bar		<input type="checkbox"/> CP	<input type="checkbox"/> Other_____
K-16251	24" (61 cm) towel bar		<input type="checkbox"/> CP	<input type="checkbox"/> Other_____
K-16252	30" (76.2 cm) towel bar		<input type="checkbox"/> CP	<input type="checkbox"/> Other_____
K-16253	Double towel bar		<input type="checkbox"/> CP	<input type="checkbox"/> Other_____
K-16254	Towel ring		<input type="checkbox"/> CP	<input type="checkbox"/> Other_____
K-16255	Vertical toilet tissue holder		<input type="checkbox"/> CP	<input type="checkbox"/> Other_____
K-16256	Robe hook		<input type="checkbox"/> CP	<input type="checkbox"/> Other_____
K-16257	Valet		<input type="checkbox"/> CP	<input type="checkbox"/> Other_____
K-16258	Glass shelf		<input type="checkbox"/> CP	<input type="checkbox"/> Other_____
K-16259	Soap dish		<input type="checkbox"/> CP	<input type="checkbox"/> Other_____
K-16260	Tumbler		<input type="checkbox"/> CP	<input type="checkbox"/> Other_____
K-16262	Knob cabinet hardware		<input type="checkbox"/> CP	<input type="checkbox"/> Other_____
K-16263	Pull cabinet hardware		<input type="checkbox"/> CP	<input type="checkbox"/> Other_____

Product Specification

The accessories shall be of metal construction. Accessories shall include installation hardware and complement the Margaux Suite. Accessories shall be Kohler Model K-____-____.

Installation Notes

Install this product according to the installation guide.

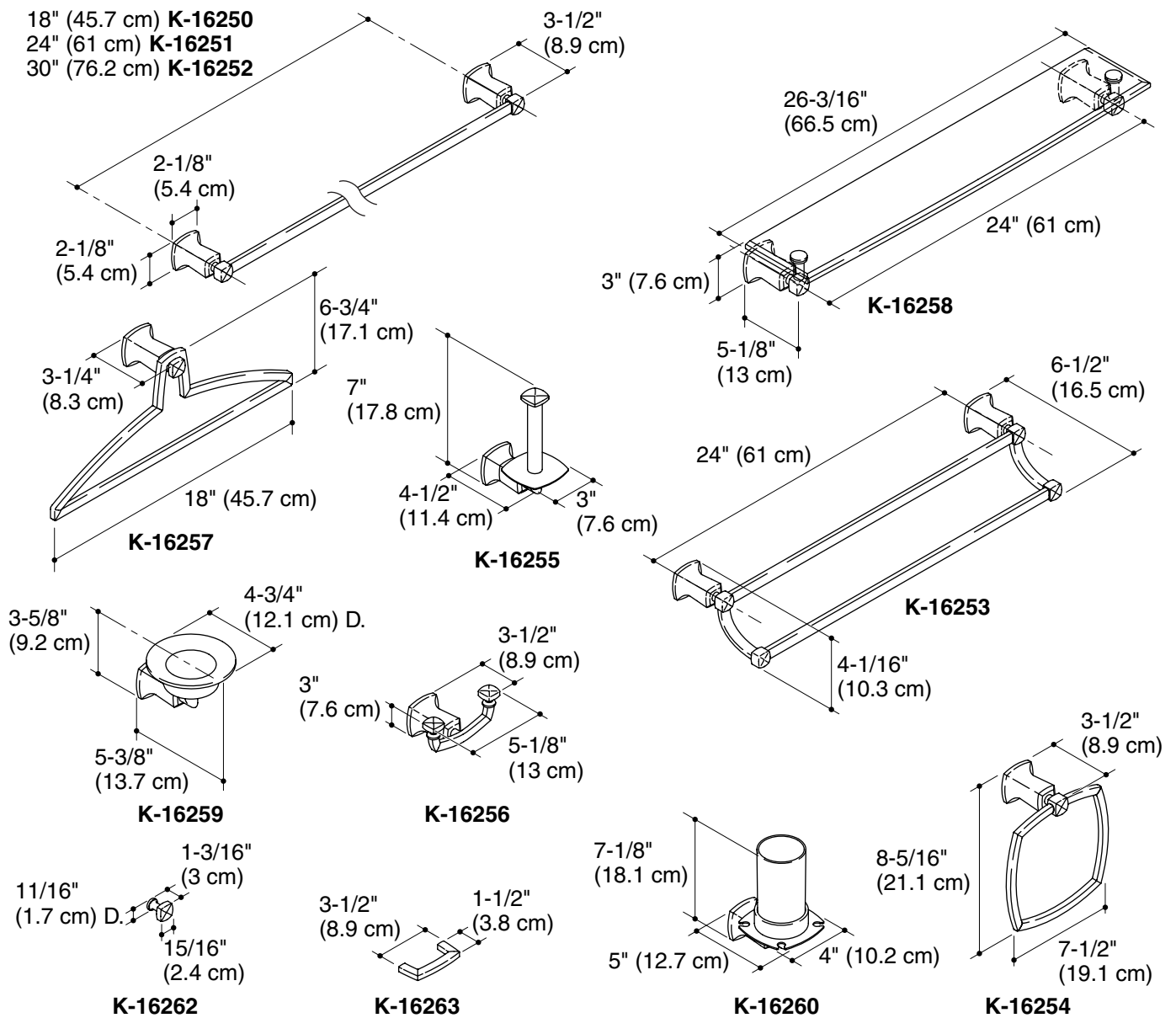

Product Diagram