

Features

- Vitreous china.
- Elongated bowl.
- AquaPiston® flushing system.
- One-piece.
- Less supply.
- 12" (305 mm) rough-in.
- 1.28 gpf (4.8 lpf).
- 2-1/8" (54 mm) glazed trapway.
- Includes left-hand polished chrome trip lever, seat, and cover.
- 11" (279 mm) x 8-1/8" (206 mm) water area.
- 27-3/4" (705 mm) x 18-3/4" (476 mm) x 28-3/16" (716 mm).

Recommended Accessories

- K-4636 Toilet Seat
- K-4650 Toilet Seat
- K-4731-C Commercial Heavy-duty Toilet Seat
- K-7637 Angle Supply with Stop (single)

Optional Accessories

- K-9169-L Trip lever

Components

Product includes:

- K-4774 Toilet Seat
- Additional included component/s: Tank cover, Trip lever, Bolt cap accessory pack, and Tank accessory pack.



ADA **CSA B651** **OBC**

Codes/Standards







- ASME A112.19.2/CSA B45.1
- DOE - Energy Policy Act 1992
- EPA WaterSense®
- ADA
- ICC/ANSI A117.1
- CSA B651
- OBC

KOHLER® One-Year Limited Warranty

See website for detailed warranty information.

Available Color/Finishes

Color tiles intended for reference only.

Color	Code	Description
	0	White
	96	Biscuit
	47	Almond
	NY	Dune
	95	Ice™ Grey
	G9	Sandbar
	7	Black Black™

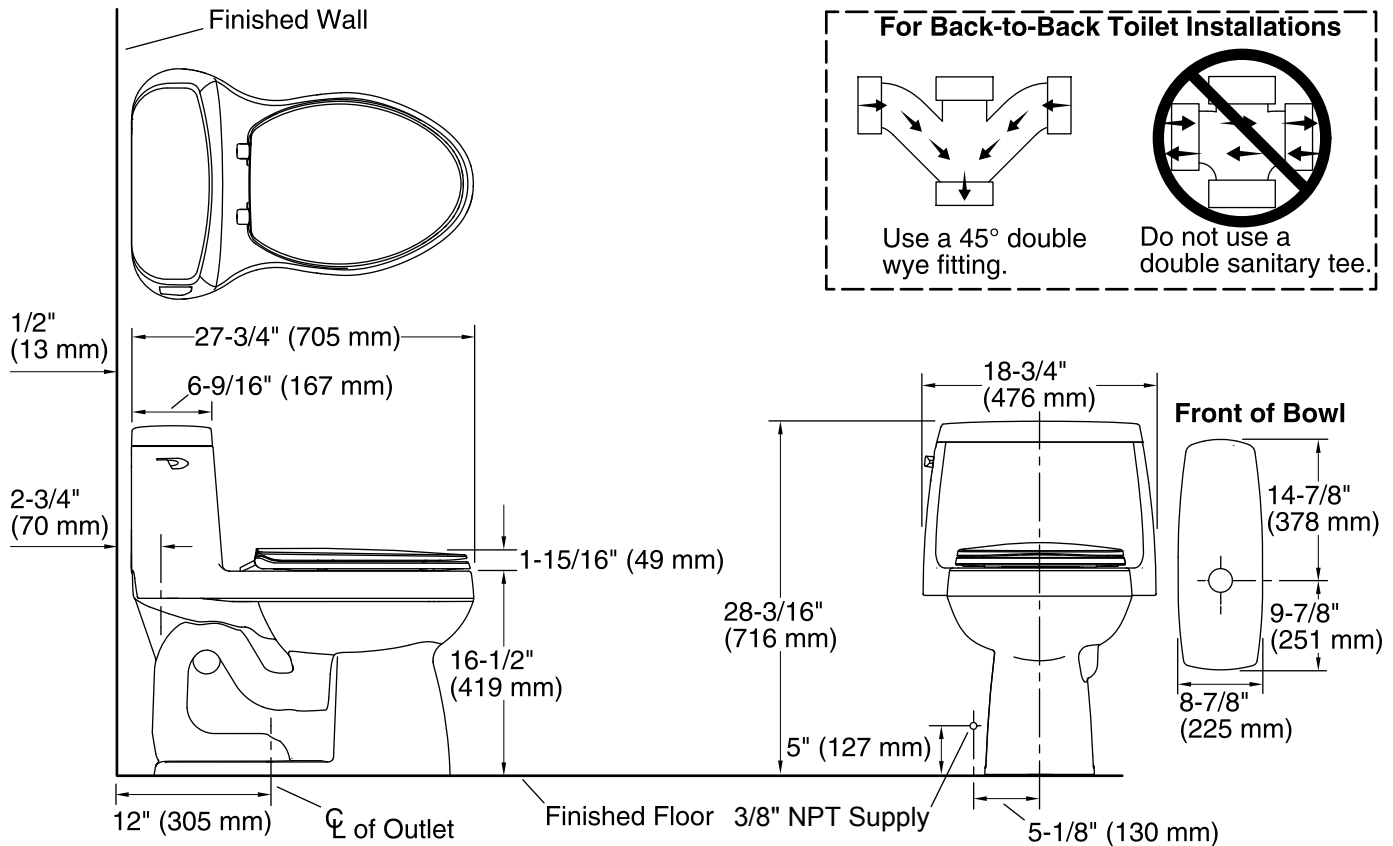

Technical Information

All product dimensions are nominal.

Toilet type:	One-piece
Bowl shape:	Compact Elongated front
Flush type:	AquaPiston
Trap passageway:	2-1/8" (54 mm)
Water Consumption	
Full:	1.28 gpf (4.8 lpf)
Water surface size:	11" x 8-1/8" (279 mm x 206 mm)
Rim to water surface:	6-1/4" (159 mm)
Rough-in:	12" (305 mm)
Seat-mounting holes:	5-1/2" (140 mm)

Notes

Install this product according to the installation guide.

For back-to-back toilet installations: Use only a 45° double wye fitting.

The model is acceptable for left-hand Accessible compartment installations only.

ADA, OBC, CSA B651 compliant when installed to the specific requirements of these regulations.

The Model Plumbing Codes require the installation of elongated open-front toilet seats on public bathrooms.