

Features

- Integral flange.
- Left drain.
- Integral lumbar support.
- Integral apron.
- Coordinates with other products in the Memoirs® collection.
- 60" (1524 mm) x 33-3/4" (857 mm) x 17-7/16" (443 mm)

Material

- Cast iron with Safeguard® finish.

Installation

- Alcove

Recommended Accessories

- K-7161-AF Bath Drain
- K-1491 Bath/Whirlpool Pillow
- K-1601 Bath/Whirlpool Footstop
- K-7213 27" Cable Bath Drain
- K-7214 27" Cable Bath Drain
- K-7259 Clearflo Bath Drain
- K-37380 30" Rough-in Cable Bath Drain
- K-37383 30" Rough-in Cable Bath Drain
- K-702200-G54 Frameless Sliding Bath Door
- K-702200-G73 Frameless Sliding Bath Door
- K-702200-L Frameless Sliding Bath Door
- K-702205-L Frameless Sliding Bath Door
- K-706000-D3 Frameless Sliding Bath Door
- K-706000-L Frameless Sliding Bath Door
- K-706003-L Frameless Sliding Bath Door
- K-706004-D3 Frameless Sliding Bath Door
- K-706004-L Frameless Sliding Bath Door
- K-706007-L Frameless Sliding Bath Door



ADA	CSA B651	OBC
-----	----------	-----

Codes/Standards





ASME A112.19.1/CSA B45.2
ASTM F462
ASTM F462
ADA
ICC/ANSI A117.1
CSA B651
OBC

KOHLER® Lifetime Limited Warranty for Cast Iron Components

See website for detailed warranty information.

Available Color/Finishes

Color tiles intended for reference only.

Color	Code	Description
	0	White
	96	Biscuit
	47	Almond
	NY	Dune
	G9	Sandbar

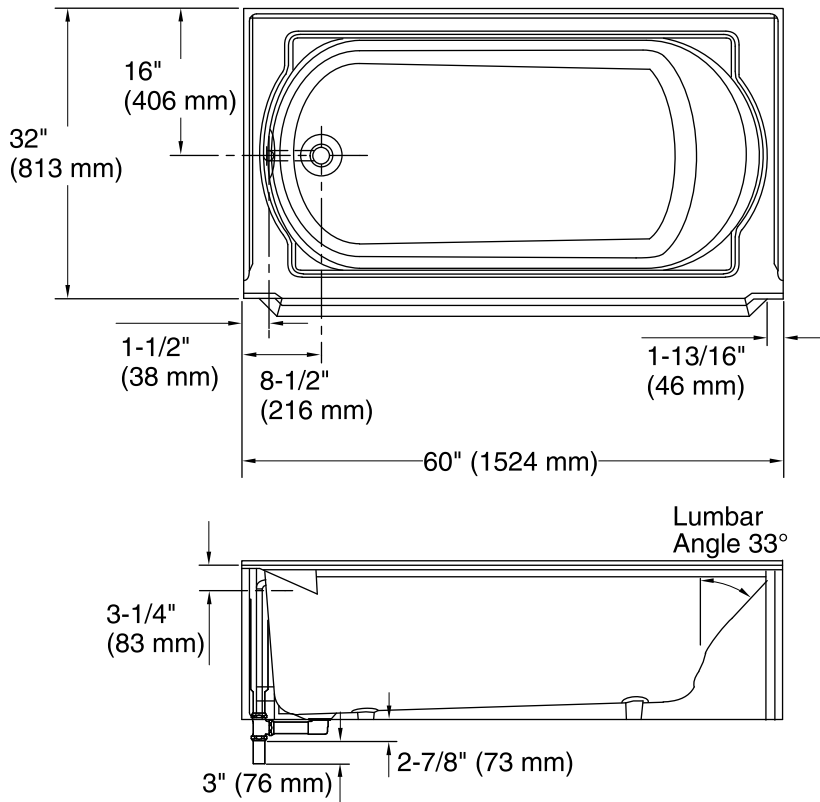

No change in measurements if connected with drain illustrated. (K-7161-AF)

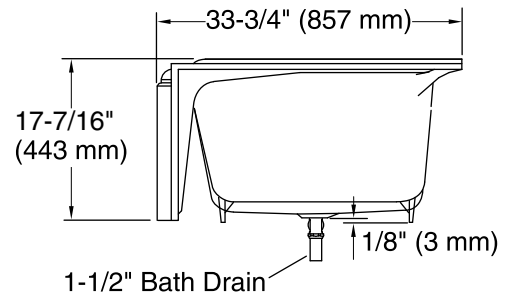

Technical Information

All product dimensions are nominal.

Installation:	3-Wall Alcove
Drain location:	Left
Basin area, bottom:	45" x 23" (1143 mm x 584 mm)
Basin area, top:	54" x 25" (1372 mm x 635 mm)
Weight:	350 lbs (158.8 kg)
Minimum floor load:	61 lbs/ft ² (297.8 kg/m ²)
Water depth:	11-5/8" (295 mm)
Water capacity:	52 gal (196.8 L)
Minimum flat for door:	2" (51 mm)

Notes

Measure your actual product for rough-in details.

Install this product according to the installation instructions.

The hot water supply should be 70% of the capacity of the bath or greater. Installations will vary.

ADA, OBC, CSA B651 compliant when installed to the specific requirements of these regulations.