

TECHNICAL SPECIFICATION SHEET

FRONT

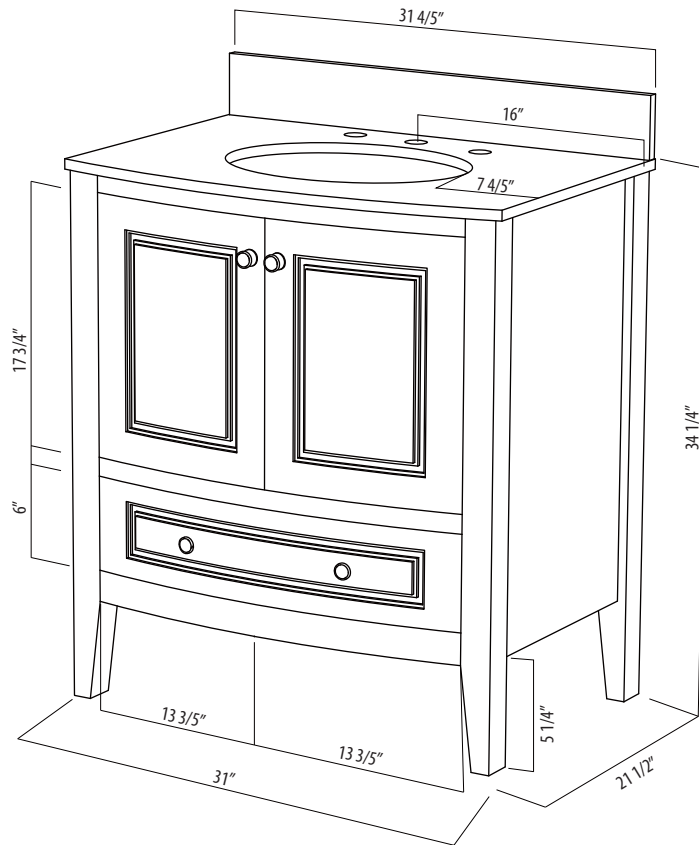

DIMENSIONS: W 31 4/5" | D 22" | H 34 1/4"

BACK

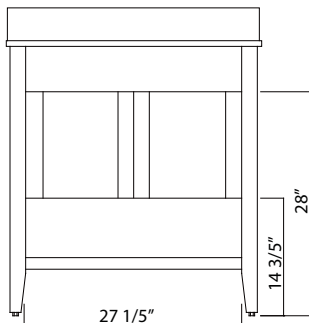

TOP

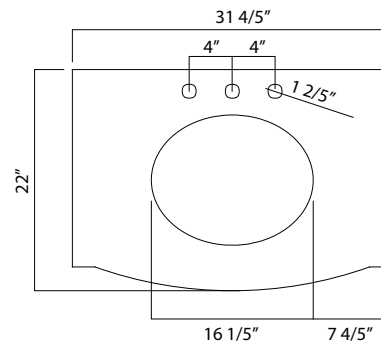

WARRANTY

Miseno warrants cabinets, mirrors, finishes and fittings to be free from defects in workmanship and materials under normal use and service for a period of one (1) year.

Please report any damage or missing pieces of your vanity to us immediately. All damages must be reported within 30 days from date of delivery.

CONTACT SUPPORT

PHONE: (855) 480-2915

EMAIL: infoservice@miseno.com

ADDRESS: 402 Otterson Drive, Suite 100, Chico CA 95928