

► **Description**

Exposed, Battery Powered, Sensor Operated G2® Model Water Closet Flushometer for floor mounted or wall hung top spud bowls.

► **Flush Cycle**

- Model 8116-1.6 Low Consumption (1.6 gpf/6.0 Lpf)
- Model 8116 Water Saver (3.5 gpf/13.2 Lpf)

► **Specifications**

- Quiet, Exposed, Diaphragm Type, Chrome Plated Closet Flushometer for either left or right hand supply with the following features:
- PERMEX™ Synthetic Rubber Diaphragm with Dual Filtered Fixed Bypass
 - Flex Tube Diaphragm designed for improved life and reduced maintenance
 - ADA Compliant OPTIMA *Plus*® Battery Powered Infrared Sensor for automatic "No Hands" operation
 - Infrared Sensor with Multiple-focused, Lobular Sensing Fields for high and low target detection
 - Isolated Latching Solenoid Operator, isolates magnetic components from water contact
 - Engineered Metal Cover with replaceable Lens Window
 - User friendly three (3) second Flush Delay
 - Courtesy Flush™ Override Button
 - Four (4) Size AA Batteries factory installed
 - "Low Battery" Flashing LED
 - Infrared Sensor Range Adjustment Screw
 - Initial Set-up Range Indicator Light (first 10 minutes)
 - 1" I.P.S. Screwdriver Bak-Chek™ Angle Stop
 - Free Spinning, Vandal Resistant Stop Cap
 - Adjustable Tailpiece
 - High Back Pressure Vacuum Breaker Flush Connection with One-piece Bottom Hex Coupling Nut
 - Spud Coupling and Flange for 1½" Top Spud
 - Sweat Solder Adapter with Cover Tube and Cast Set Screw Wall Flange
 - High Copper, Low Zinc Brass Castings for Dezincification Resistance
 - Fixed Metering Bypass and No External Volume Adjustment to Ensure Water Conservation
 - Flush Accuracy Controlled by CID™ Technology
 - Diaphragm, Stop Seat and Vacuum Breaker to be molded from PERMEX™ Rubber Compound for Chloramine resistance

Valve Body, Tailpiece and Control Stop shall be in conformance with ASTM Alloy Classification for Semi-Red Brass. Valve shall be in compliance with the applicable sections of ASSE 1037, ANSI/ASME A112.19.6 and Military Specification V-29193. Installation conforms to ADA requirements.

► **Special Finishes**

- PB** Polished Brass (PVD Finish)
- GP** Gold Plate (PVD Finish)
- BN** Brushed Nickel (PVD Finish)
- SF** Satin Chrome

See Accessories Section and OPTIMA Accessories Section of the Sloan catalog for details on these and other OPTIMA *Plus*® Flushometer variations.

The Model 8116 valve is designed for installations where the water supply is roughed-in 27" (686 mm) above the top of the water closet. While the Model 8116 no longer requires the use of a Beam Deflector, for new installations Sloan still recommends the use of the Model 8111 valve which has a shorter installation height.

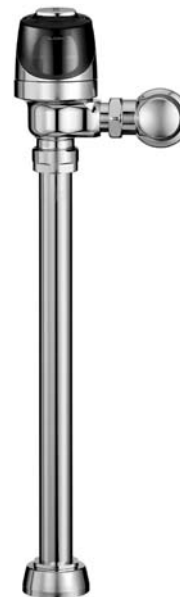

► **ADA Compliant**

► **Automatic**

Sloan G2 Optima *Plus*® Flushometers activate via multi-lobular sensor detection to provide the ultimate in sanitary protection and automatic operation. A battery powered infrared sensor sets the flushing mechanism after the user is detected and completes the flush when the user steps away.

► **Functional & Hygienic**

Touchless, sensor operation eliminates the need for user contact to help control the spread of infectious diseases. The G2 Optima *Plus* Flushometer is provided with an Override Button to allow a "courtesy flush" for individual user comfort.

► **Economical**

Sloan installed batteries speed installation and provide years of metered flushing to control the use of water and energy. Batteries can be changed without turning off the water. The patented Isolated Operator ensures reliability by isolating the solenoid components from the water.

► **Warranty**

5 year (limited)



This space for Architect/Engineer approval

Job Name _____	Date _____
Model Specified _____	Quantity _____
Variations Specified _____	
Customer/Wholesaler _____	
Contractor _____	
Architect _____	

Model 8116



Description

Exposed, Battery Powered, Sensor Operated G2® Model Water Closet Flushometer for floor mounted or wall hung top spud bowls.

Flush Cycle

- Model 8116-1.6 Low Consumption (1.6 gpf/6.0 Lpf)
- Model 8116 Water Saver (3.5 gpf/13.2 Lpf)

ELECTRICAL SPECIFICATIONS

Control Circuit

- Solid State
- 6 VDC Input
- 8 Second Arming Delay
- 3 Second Flush Delay

OPTIMA Sensor Type

Active Infrared

OPTIMA Sensor Range

Nominal 22" - 42" (559 mm - 1067 mm), Adjustable \pm 8" (203 mm)

Battery Type

(4) AA Alkaline

Battery Life

3 Years @ 4,000 Flushes/Month

Indicator Lights

Range Adjustment/Low Battery

Operating Pressure

15 - 100 psi (104 - 689 kPa)

Sentinel Flush

Once Every 24 Hours After the Last Flush

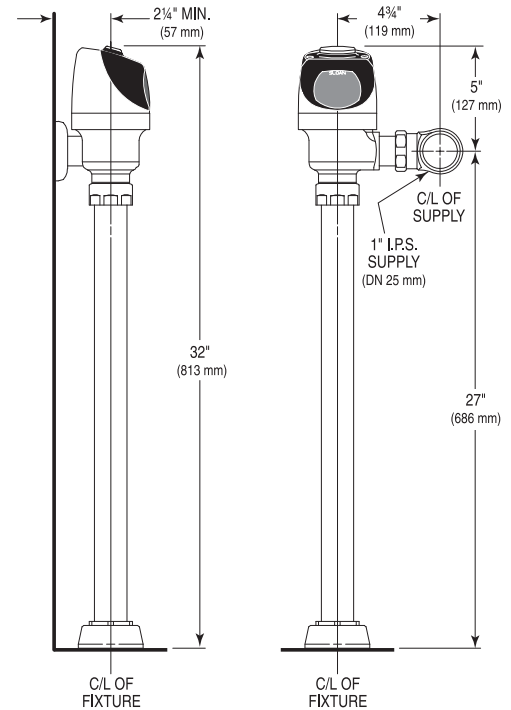

OPERATION

1. A continuous, invisible light beam is emitted from the OPTIMA Plus Sensor.

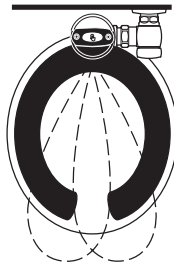

2. As the user enters the beam's effective range (22" to 42") the beam is reflected into the OPTIMA Plus Scanner Window and transformed into a low voltage electrical circuit. Once activated, the Output Circuit continues in a "hold" mode for as long as the user remains within the effective range of the Sensor.

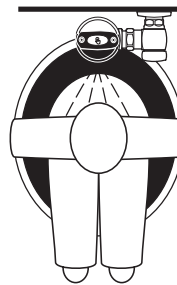

3. When the user steps away from the OPTIMA Plus Sensor, the circuit waits 3 seconds (to prevent false flushing) then initiates an electrical signal that operates the Solenoid. This initiates the flushing cycle to flush the fixture. The Circuit then automatically resets and is ready for the next user.

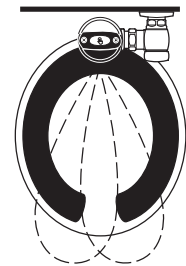

VALVE ROUGH-IN

Model 8116

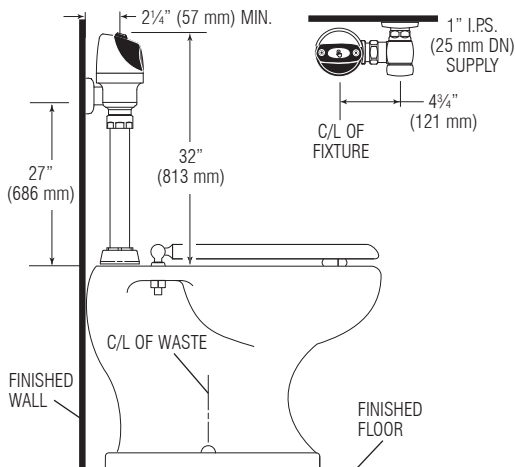

The Model 8116 valve is designed for installations where the water supply is roughed-in 27" (686 mm) above the top of the water closet. For new installations, Sloan strongly recommends the use of our Model 8111 which has a shorter installation height.

When installing the G2 Optima Plus in a handicap stall:

Per the ADA Guidelines (section 604.9.4) it is recommended that the grab bars be split or shifted to the wide side of the stall.

SLOAN VALVE COMPANY • 10500 SEYMOUR AVENUE • FRANKLIN PARK, IL 60131

Phone: 1-800-9-VALVE-9 or 1-847-671-4300 • Fax: 1-800-447-8329 or 1-847-671-4380 • www.sloanvalve.com