

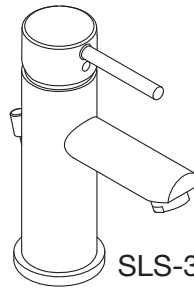

Location:

SLS-3512-1.5, SLS-3510-1.5
Single Handle Lavatory Faucet
Specification Submittal





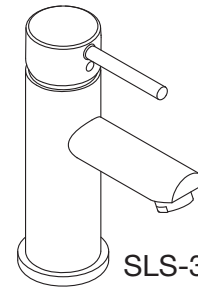

SLS-3512-1.5



SLS-3510-1.5



Model Numbers	Feature Highlights
<input type="checkbox"/> SLS-3512-1.5 <i>Single Handle Lavatory Faucet with lift rod and metal drain assembly</i> <input type="checkbox"/> SLS-3510-1.5 <i>Single Handle Lavatory Faucet, lift rod and drain not included</i>	<ul style="list-style-type: none"> • Single hole mount configuration • Quarter turn ceramic cartridge • 23 inch braided hose water supply connections • 7-1/8" height • Lift rod and metal drain assembly (SLS-3512-1.5) • Standard 1.5 gpm (5.7 L/min) flow rate • Faucet shall be metal construction, plated in standard polished chrome finish
Finish Options/Modifications	Compliance
<input type="checkbox"/> -0.5  <i>0.5 gpm (1.9 L/min) flow restrictor</i> <input type="checkbox"/> -1.0  <i>1.0 gpm (3.8 L/min) flow restrictor</i> <input type="checkbox"/> Delete Suffix 1.5 <i>2.2 gpm (8.3 L/min) flow restrictor</i> <input type="checkbox"/> -DP4 <i>4" deck plate</i> <input type="checkbox"/> -G <i>Grid drain</i> <input type="checkbox"/> -BBZ <i>Brushed Bronze finish</i> <input type="checkbox"/> -MB <i>Matte Black finish</i> <input type="checkbox"/> -STN <i>Satin Nickel finish</i>	<p>-ASME A112.18.1/CSA B125.1 -NSF/ANSI 61.9; NSF/ANSI 372 -WaterSense 1.0 gpm, 1.5 gpm</p>  
<p>Note: Append appropriate -suffix to model number.</p>	Warranty
	<p>Limited Lifetime - to the original end purchaser in consumer/residential installations. 5 Years - for industrial/commercial installations. Refer to www.symmons.com/warranty for complete warranty information.</p>

Dimensions

Notes:

- (1) Dimensions subject to change without notice
- (2) Lift rod included with model SLS-3512-1.5 only

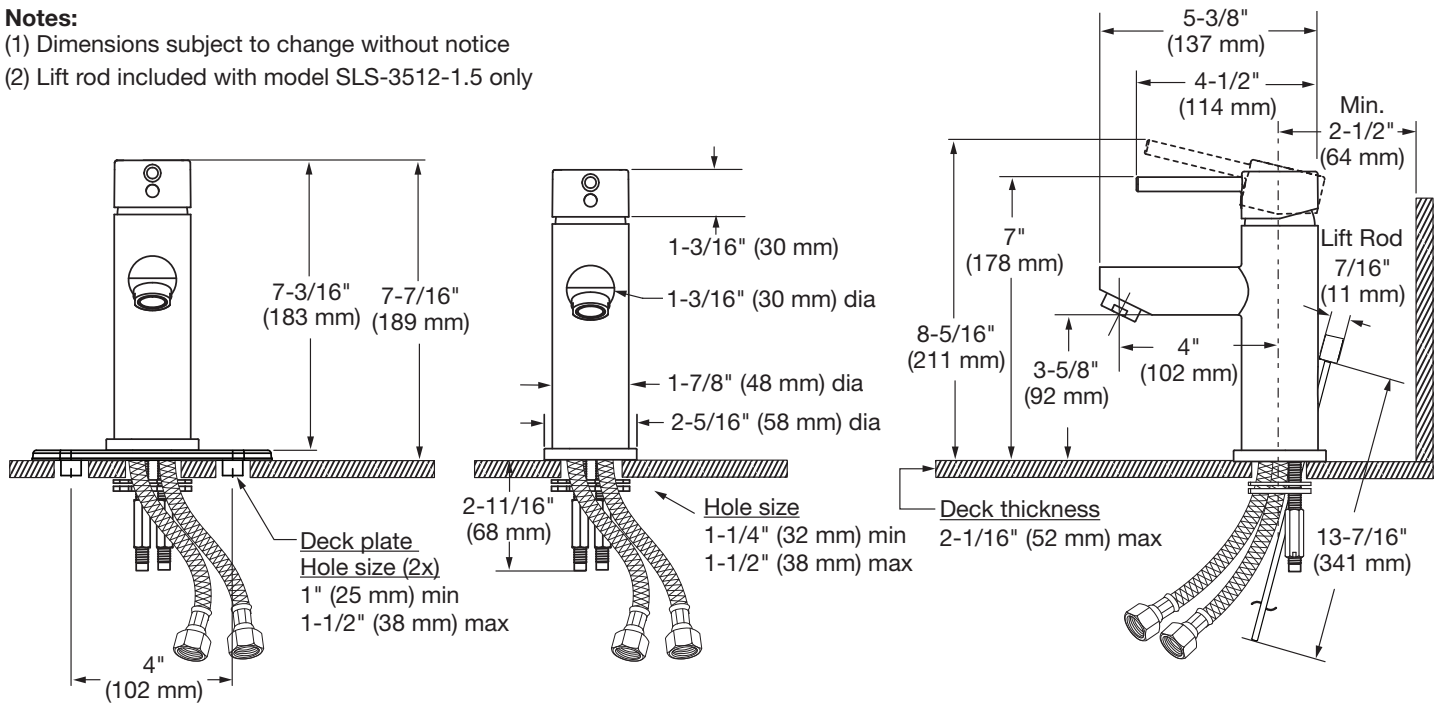



Ubicación:

SLS-3512-1.5, SLS-3510-1.5
Grifo para lavabo con una sola manija
Presentación de especificaciones

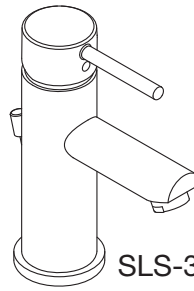



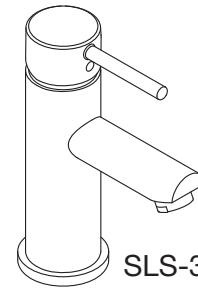

SLS-3512-1.5



SLS-3510-1.5



Números de modelo	Características destacadas
<input type="checkbox"/> SLS-3512-1.5 <i>Grifo para lavabo con una sola manija con varilla de levantamiento y conjunto de desagüe metálico</i> <input type="checkbox"/> SLS-3510-1.5 <i>Grifo para lavabo con una sola manija, varilla de levantamiento y desagüe no incluidos</i>	<ul style="list-style-type: none"> • Configuración de montura en un solo orificio • Cartucho de cerámica con un cuarto de vuelta • Manguera trenzada de 23 pulgadas con conexiones para suministro de agua • 7-1/8" de altura • Varilla de levantamiento y conjunto de desagüe metálico (SLS-3512-1.5) • Caudal estándar de 1.5 gal/min (5.7 L/min) • El grifo será de materiales metálicos, revestidos con un acabado cromado pulido estándar.
Opciones / Modificaciones de acabado	Cumplimiento
<input type="checkbox"/> -0.5  <i>Reductor de caudal de 0.5 gal/min (1.9 L/min)</i> <input type="checkbox"/> -1.0  <i>Reductor de caudal de 1.0 gal/min (3.8 L/min)</i> <input type="checkbox"/> Eliminar sufijo 1.5 <i>Reductor de caudal de 2.2 gal/min (8.3 L/min)</i> <input type="checkbox"/> -DP4 <i>Placa de cubierta de 4"</i> <input type="checkbox"/> -G <i>Desagüe en rejilla</i> <input type="checkbox"/> -BBZ <i>Acabado en bronce cepillado</i> <input type="checkbox"/> -MB <i>Acabado en negro mate</i> <input type="checkbox"/> -STN <i>Acabado en níquel satinado</i>	<p>-ASME A112.18.1/CSA B125.1 -NSF/ANSI 61.9; NSF/ANSI 372 -WaterSense 1.0 gal/min, 1.5 gal/min</p>  
<p>Nota: Anexar el -sufijo apropiado al número de modelo.</p>	Garantía
<p>Limitada de por vida - para el comprador original del producto en establecimientos del consumidor/residenciales. 5 años - para instalaciones industriales y comerciales. Consulte www.symmons.com/warranty para obtener información completa sobre la garantía.</p>	

Dimensiones

Notas:

- (1) Las dimensiones pueden cambiar sin previo aviso
- (2) La varilla de levantamiento solamente se incluye con el modelo SLS-3512-1.5

