

UPTON®
Trim only for Control Valve

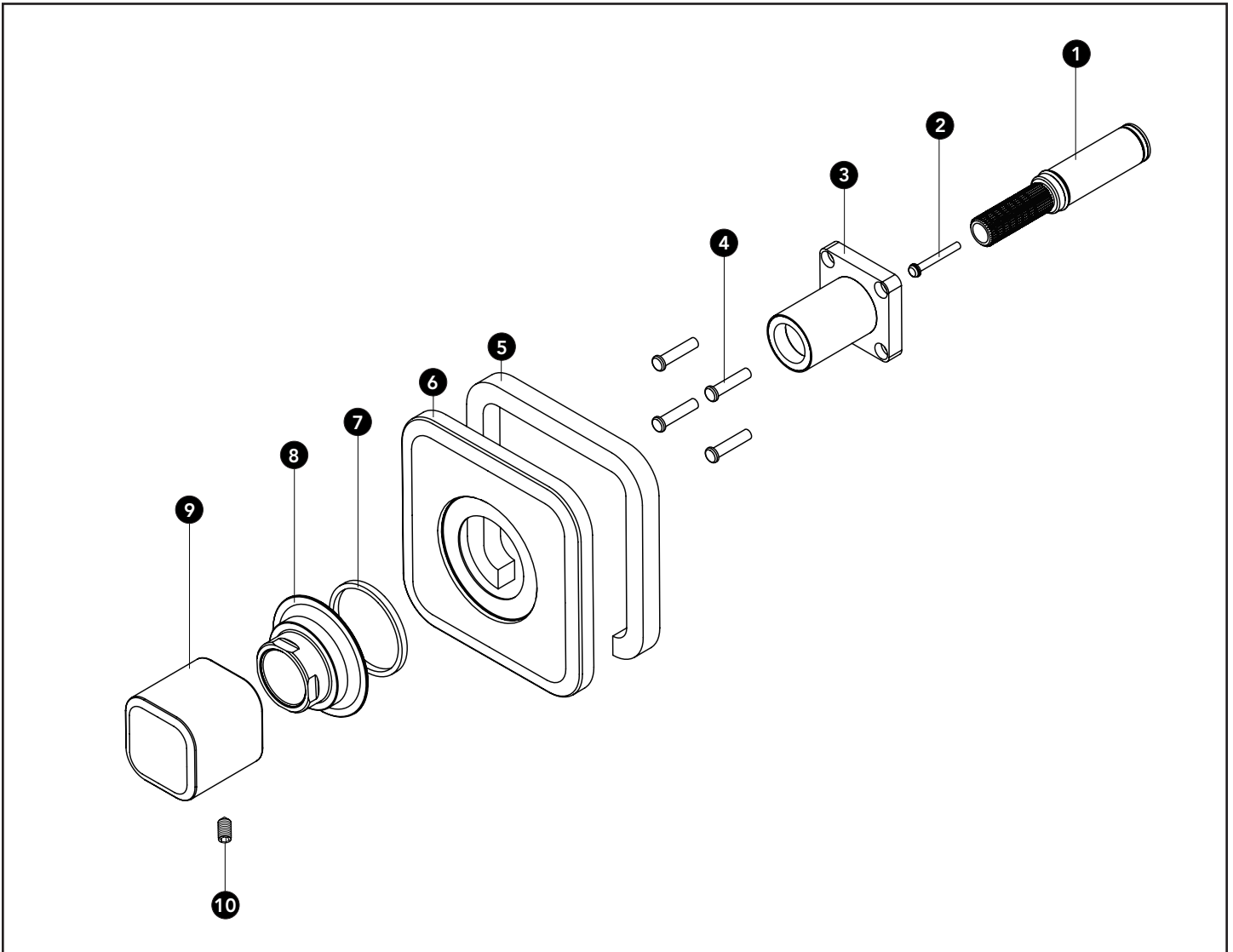

Item	Part	Description
1	THP4532	Valve Stem Extension
2	THP4533	Long Screw and Washer
3	THP4534	Threaded Base
4	THP4535	Short Screw x 4
5	THP4543	Faceplate Gasket
6	THP4544#\$\$	Faceplate
7	THP4536	Escutcheon Gasket
8	THP4537#\$\$	Escutcheon
9	THP4546#\$\$	Volume Control Knob
10	THP4538	Set Screw

LEGEND
\$\$ = Denotes Finish
#CP = Polished Chrome
#BN = Brushed Nickel
#PN = Polished Nickel