

Installation Instructions / Warranty

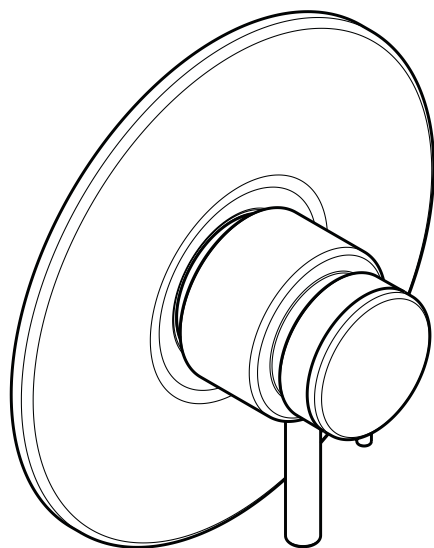

ThermoBalance II™ Rough Valve
ThermoBalance II™ Trim

hansgrohe

ThermoBalance II Rough Valve

06623000

ThermoBalance II Rough Valve with Stops

06627000

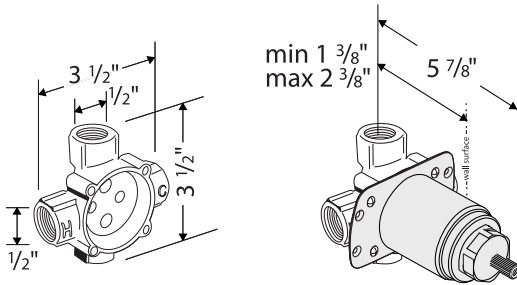

The thermoelement shown is included with the trim kit.

The Service (Isolation) Stops

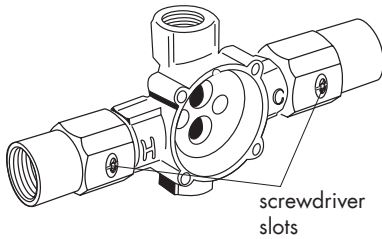

Rough-in 06627000 has service (isolation) stops built onto the valve. When the screwdriver slots is horizontal, the stops are in the "on" position. When the screwdriver slots are vertical, the stops are in the "off" position.

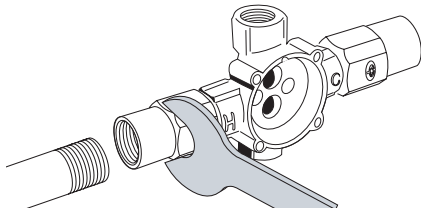

When connecting the hot and cold supplies, hold the stop steady with a wrench to avoid stop mis-alignment, and breakage of the factory sealed thread compound.

Technical Specifications

Recommended Pressure	45 - 72 psi
Maximum Incoming Hot Water Temperature	165° F*
Recommended Incoming Hot Water Temp.	120 - 140° F*
Nominal Capacity @ 45 PSI	8 gpm
Nominal Capacity @ 60 PSI	11.5 gpm
Safety Stop	100° F
Maximum Output Temperature	110° F**
1/2" IPS Connections	

*Please know and follow all applicable local plumbing codes when setting the temperature on the water heater. In Massachusetts, the water heater may be set no higher than 112°F.

**The high temperature limit stop may be reset to comply with local plumbing codes. See page 10.

Installation Considerations

- For best results, this unit should be installed by a licensed, professional plumber.
- Large pressure differences between the hot and cold supplies should be balanced.
- Before beginning the installation, please read the instructions thoroughly. Inspect the product and make sure that all parts are present and in good condition. If you have questions, contact Hansgrohe Technical Services.
- ThermoBalance II rough 06623000 does not include service stops. If service stops are required by local plumbing code, order the stops separately (part #06900300) or order ThermoBalance II rough 06627000, which incorporates service stops.
- The ThermoBalance II is intended for use in a two-function shower. **DO NOT plug any outlet port.**
- The ThermoBalance II rough must be used with a ThermoBalance II trim kit. Do not attempt to use with any other trim kit.
- Do not attempt to use this valve in combination with a diverter tub spout.

Installation Suggestions

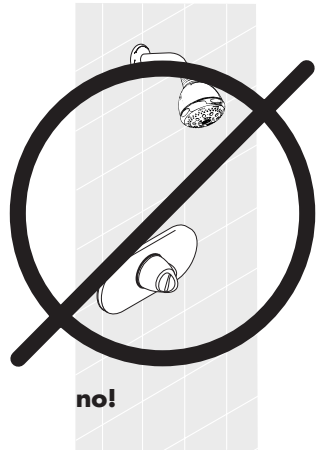
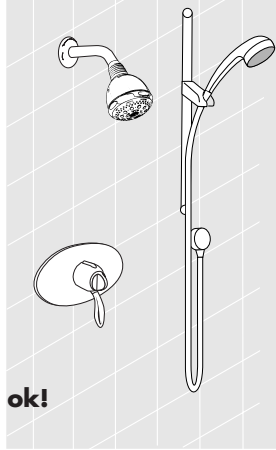
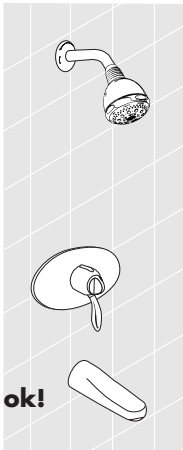

Do not use a diverter tub spout!

Use for a two-feature installation only! Do not plug either outlet port!

Install the ThermoBalance II Rough Valve

Caution: Turn the water off at the supply before proceeding.

Both outlet ports must be plumbed. Do not plug any port.

Install the hot and cold supply lines to the rough. The hot supply must be connected to the hot inlet port and the cold supply must be connected to the cold inlet port. If the supplies are not connected to the correct ports, the valve cannot work correctly.

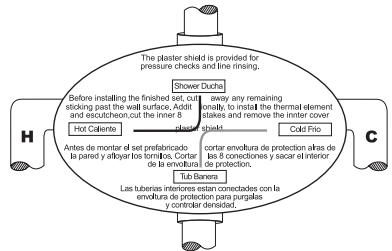

If using model 06627000: When connecting the hot and cold supplies, hold the stop steady with a wrench to avoid stop misalignment, and breakage of the factory sealed thread compound.

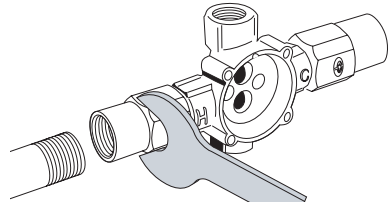

Install both outlet lines.

The valve should be level in all planes. It should be installed so that the outside surface of the finished wall falls between the minimum and maximum lines on the installation box. This will insure that the trim fits properly.

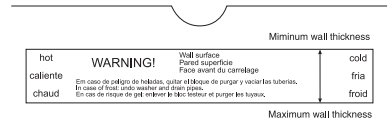

When finishing the wall, install the wall material up to the oval installation box.

The installation box will not be removed. When the trim is installed, the plaster shield portion of the installation box will be trimmed nearly flush to the wall and sealed to provide protection against water damage.

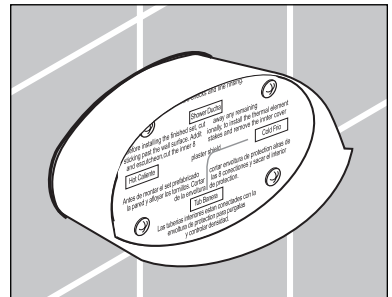

Flush the supply lines using the flushing plug

The installation box includes a flushing plug to permit line flushing and pressure testing before the cartridge and finishing parts are installed. A pressure test of the installed piping should be performed before the walls are closed.

The flushing plug permits cold water to flow from the bottom outlet and the hot water through the top outlet.

To flush the lines, install a hose bibb and hose to each outlet line. (Using a hose will permit the water to be directed to a location where it will not cause damage.) Flush the lines for at least 5 minutes.

The porting in the flushing plug prevents cross flow. However, it does not stop the flow of water through the outlet ports.

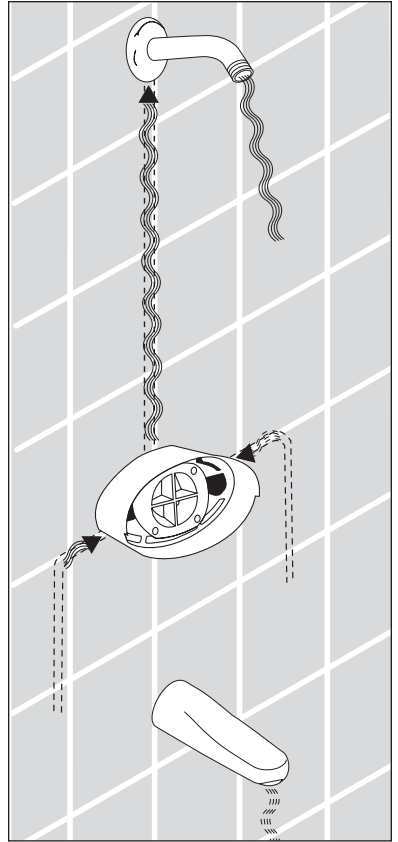

ThermoBalance II Trim Kits

These instructions cover these models:

	Valve trim only	Shower set with rough	Shower set trim
Retroaktiv Lever	06064XXX	06073XXX	06082XXX
Retroaktiv Scroll	06065XXX	06074XXX	06083XXX
Retroaktiv Cross	06066XXX	06075XXX	06084XXX
Solaris	06636XXX	06639XXX	06642XXX
Stratos	06580XXX	06583XXX	06586XXX
Metro	06656XXX	06659XXX	06662XXX
Interaktiv S	06879XXX	06882XXX	06885XXX
Metris	31317XX1	31321XX1	31324XX1
Focus S	31736XX1	31739XX1	31772XX1
Talis S	32317XX1	32321XX1	32324XX1

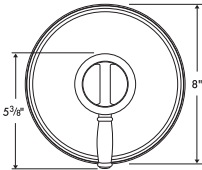

06064XXX

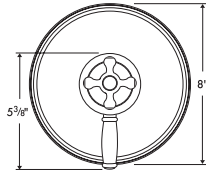

06066XXX

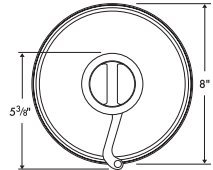

06065XXX

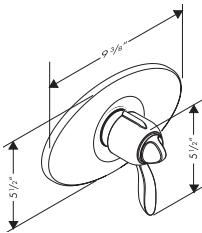

06636XXX

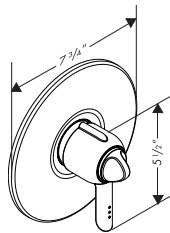

06580XXX

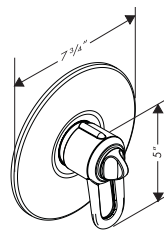

06656XXX

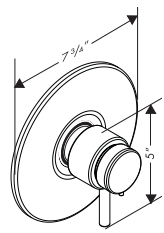

06879XXX

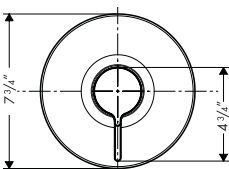

31317XX1

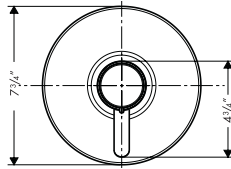

31736XX1

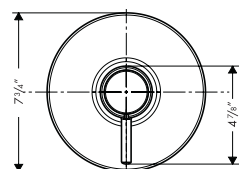

32317XX1

The finished wall must be complete and made watertight before installation of this trim kit.

Installation

Turn the water off at the main, or at the stops, before beginning.

Cut the plaster shield so that it extends 1/16" outside the surface of the finished wall. Seal the wall around the plaster shield with waterproof sealant.

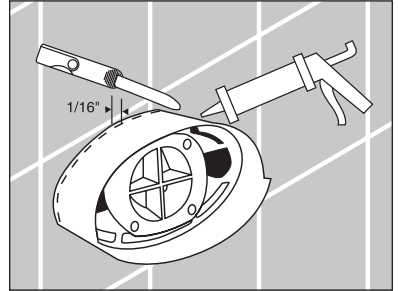

Remove the label. Cut the support arms that connect the flushing plug to the plaster shield. Remove the flushing plug. Do not discard the screws.

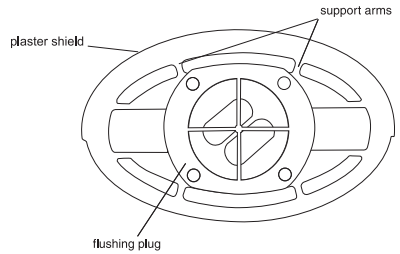

Inspect the back of the flushing plug to make sure that the blue sealing gasket was removed as well. If it is not present on the flushing plug, be sure to remove it from the rough before proceeding.

Insert the thermoelement in the rough. Make sure that the locator tab on the thermoelement goes straight into the notch in the rough.

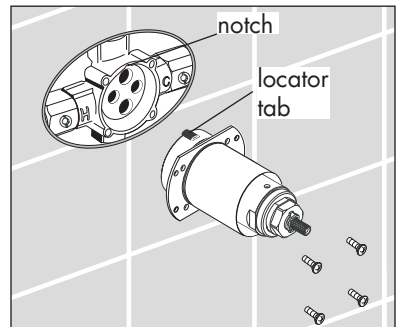

Use the flushing plug screws to connect the cartridge retainer plate to the rough. Tighten the screws evenly, using a manual screwdriver, in a cross-wise pattern. Do not overtighten the screws.

Turn on the water supplies to the valve, and check for leaks. If there is a leak around the thermoelement, turn the supplies off, and remove the thermoelement. Confirm that the sealing gasket from the flushing plug was removed. Install the thermoelement, and tighten the screws.

If the unit continues to leak, contact Hansgrohe Customer Service for a replacement thermoelement.

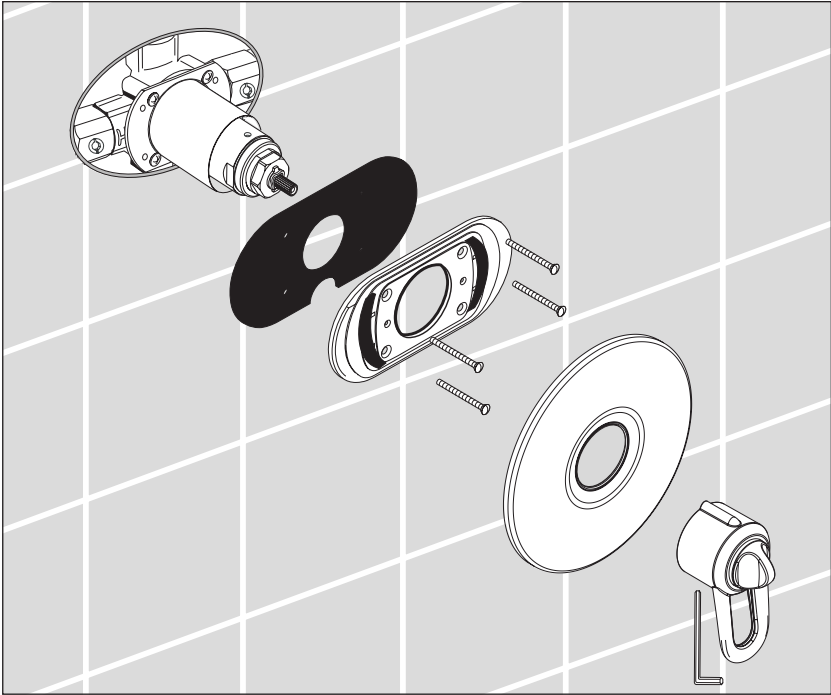

Solaris only (oval escutcheon): Snap the white plastic Duotec spacers onto the carrier plate. Install two of the Duotec strips on the spacers. Install the remaining two strips on the back of the escutcheon (trim plate).

Models with round escutcheon: Install two Duotec strips directly on the carrier plate. Install the remaining two strips on the back of the escutcheon.

All models: Install the carrier plate gasket and carrier plate with the carrier plate screws.

Press the escutcheon very firmly over the carrier plate, so that the strips of Duotec interlock, producing a very firm hold.

Install the handle. Tighten the handle screw, using a 3 mm Allen wrench. For proper operation of the valve, the handle screw must engage the slot milled into the brass on the thermoelement.

Set the high temperature limit stop (optional) – see page 10.

Justify the handle – see page 9.

Justify the Handle

Tools required:

Thermometer

3 mm Allen wrench (included with trim kit)

Turn the valve on. Place the thermometer in the water stream.

Turn the temperature control knob until the water coming out measures 100° on the thermometer.

Turn the water off using the lever part of the handle.

Use the 3 mm Allen wrench to loosen the set screw on the bottom of the handle. Remove the handle from the valve (1).

Hold the lever in one hand. With the other hand, turn the temperature control knob approximately ½ turn clockwise (2a). Then, **without pressing inward on it**, turn it counter-clockwise until it is positioned vertically and hits the safety stop (2b).

Reinstall the handle and tighten the set screw (3).

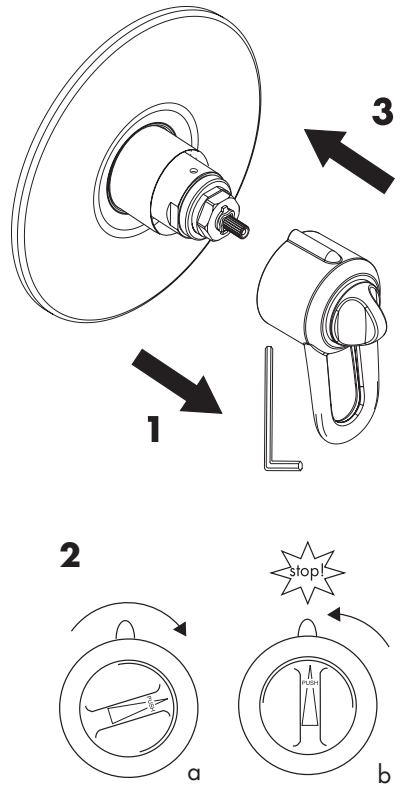

Set the High Temperature Limit Stop (optional)

IMPORTANT: Many municipalities have codes limiting the maximum discharge temperature of a shower valve to 110° F or less. Please know and follow all applicable local codes when setting the high temperature limit stop.

Tools Required:

Thermometer

3 mm Allen wrench (included with trim kit)

Turn the hot and cold supplies to the valve on.

Turn the water on using the handle.

Use the 3 mm Allen wrench to loosen the set screw on the bottom of the handle. Remove the handle.

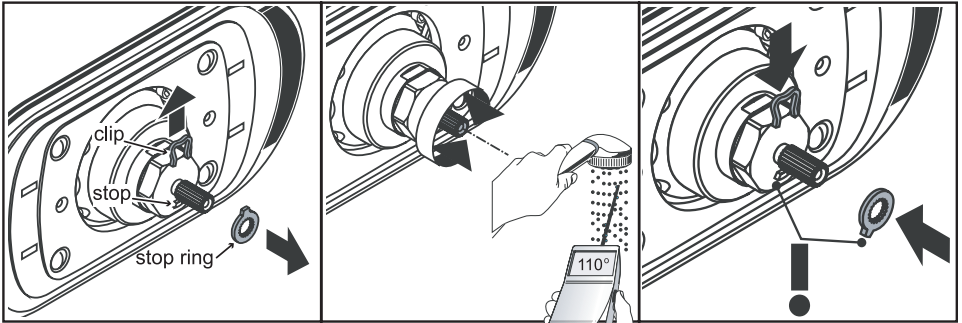

Remove the clip and stop ring from the thermostatic cartridge stem. Put them in a safe place.

Turn the thermostatic mixer stem with your fingers, clockwise to make the water cooler, counter-clockwise to make the water warmer. Turn the stem until the water coming out is the desired maximum high temperature – 110° in most areas.

Reinstall the stop ring so that it is against the stop. Reinstall the clip.

Justify and reinstall the handle.

User Instructions

The ThermoBalance II has two control features: the Temperature Selector and the Diverter / Volume Control.

Turn the Temperature Selector counter clockwise to make the water warmer. It will stop when the water is 100° F – this is the safety stop. An adult can override the safety stop by pressing inward on the Temperature Selector and continuing to turn it counter-clockwise.

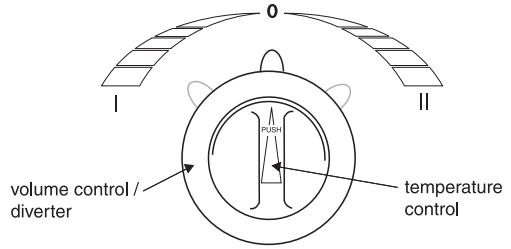

IMPORTANT: the Temperature Selector will not automatically “reset” to below 100° when the water is turned off.

Turn the Temperature Selector clockwise to make the water cooler.

The Diverter/Volume Control handle controls the water flow. The center position is “off”. Turn the handle counter-clockwise to send the water to outlet port I (the bottom outlet port); and clockwise to send the water to outlet port II (the top outlet port). The further you turn the handle from the “off” position, the greater the water flow.

Troubleshooting

Problem	Possible Cause	Solution
Water sprays from around cartridge assembly.	sealing ring from flush plug still in body of valve	remove sealing ring
Handle hard to turn	ceramic plate inside cartridge broken sealing ring from flush plug still in body of valve	replace cartridge remove sealing ring
Handle turns, but water does not turn on / off.	handle set screw not tightened	tighten handle set screw
Water drips from showerhead for several minutes after the valve is turned off	normal clearing of showerhead	not a problem
Water drips continuously from showerhead after the valve is turned off.	debris is lodged in valve, or damage to ceramic plates	replace cartridge
Water does not mix, is either hot or cold	valve body is cross-piped	re-pipe valve body correctly
Water does not get hot / cold enough	high temperature limit stop not set correctly handle not justified	re-set high temperature limit stop justify handle
Water pressure poor	isolation stops not fully open thermostatic cartridge is faulty thermostatic cartridge screens are clogged	make sure both stops are fully open replace thermostatic cartridge clean screens

Replacement Parts

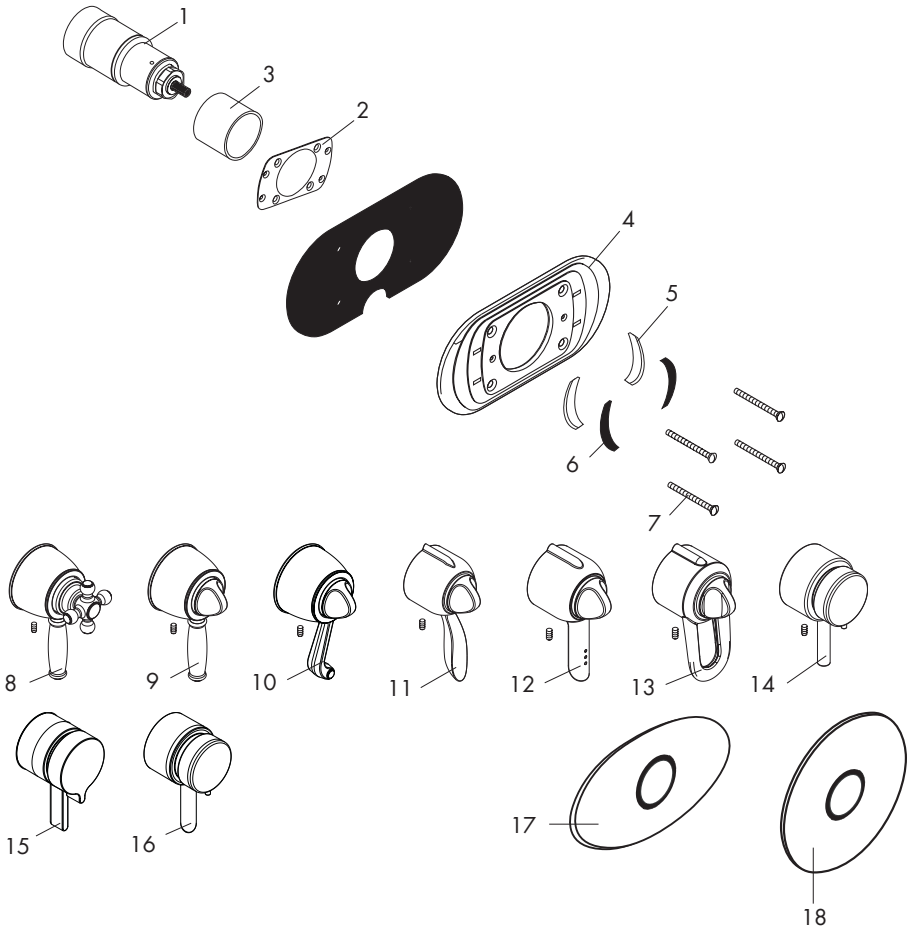

1	cartridge	88586000	17	oval escutcheon	88531XXX
2	retainer plate	88519000	18	round escutcheon	88521XXX
3	sleeve	88520XXX	19	Retroaktiv escutcheon	
4	carrier plate	88518000			
5	Duotec spacers	88529000		XXX = color code	
6	Duotec strips	96234000		000 = chrome	
7	carrier plate screw	88652000		620 = oil rub bronze	
8	cross handle	88608XXX		820 = brushed nickel	
9	lever handle	88610XXX		830 = polished nickel	
10	scroll handle	88609XXX		930 = polished brass	
11	Solaris handle	88530XXX			
12	Stratos handle	88547XXX			
13	Metro handle	88548XXX			
14	Interaktiv S/Talis S	88641XXX			
15	Metris handle				
16	Focus S handle				

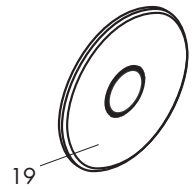

Maintenance: Cleaning the filter screens

CAUTION: Turn off the water to the shower, either at the main or with the service stops, before opening the valve.

Loosen the set screw on the bottom of the handle with a 3 mm Allen wrench. Remove the handle. Pull the escutcheon away from the wall.

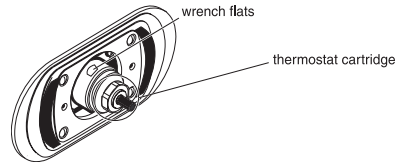

Grasp the wrench flats on the stop unit with an adjustable wrench.

While holding the stop unit still, use a second adjustable wrench or a 17mm deep socket wrench to unscrew and remove the thermostatic cartridge.

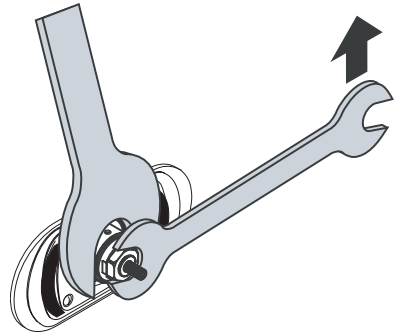

Rinse any debris from the filter screens on the thermostatic cartridge. A soft toothbrush and mild soap may be used to remove stubborn debris, excess solder flux, etc. from the screens. Do not attempt to remove the screens.

Lubricate the o-rings with white plumbers grease. Reinstall the thermostatic cartridge in the stop unit.

Justify and reinstall the handle.

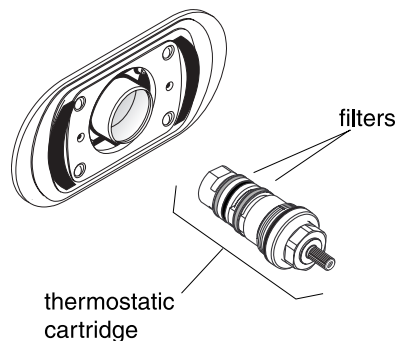

Cleaning Recommendation for Hansgrohe Products

Modern faucetry and shower products utilize a combination of materials to comply with the needs of the market with regard to design and functionality.

To avoid damage, it is necessary to use some caution when cleaning. Damage caused by improper treatment is not covered under the Hansgrohe warranty.

Cleaning Materials for Faucets and Showers

- To remove lime scale, use only products made specifically for that purpose. Always follow the manufacturer's instructions when using.
- Do not use cleaners that contain hydrochloric, formic, acetic, or phosphoric acids, as these will cause considerable damage to finishes and to plastic components.
- Never mix cleaning materials.
- Never use cleaners containing abrasives. Do not use abrasive cleaning cloths, pads, or sponges.

Cleaning Procedures

- Clean your faucets and shower products as and when required. Regular cleaning will prevent scale buildup and water spotting.
- Follow the label instructions. Do not allow any cleaner to remain on the product for longer than necessary.
- When using spray cleaners, spray first onto a sponge or cloth – do not spray directly onto the product.
- After cleaning, rinse thoroughly with clear water to remove any cleaner residue.

Important

- Soap and shampoo residue can also cause damage to the product. Rinse well with clean water after use.
- If the surface is already damaged, harsh cleaning materials will cause further damage.

Limited Lifetime Consumer Warranty

This product has been manufactured and tested to the highest quality standards by Hansgrohe, Inc. ("Hansgrohe"). This warranty is limited to Hansgrohe products which are purchased by a consumer in the United States after March 1, 1996, and installed in either the United States or Canada.

WHO IS COVERED BY THE WARRANTY

This warranty extends to the original consumer purchaser only.

WHAT IS COVERED BY THE WARRANTY

This warranty covers only your Hansgrohe manufactured product. Hansgrohe warrants this product against defects in material or workmanship as follows: Hansgrohe will repair at no charge for parts only or, at its option, replace any product or part of the product which proves defective because of improper workmanship and/or material, under normal installation, use, service and maintenance. If Hansgrohe is unable to provide a replacement and repair is not practical or cannot be timely made, Hansgrohe may elect to refund the purchase price in exchange for the return of the product.

LENGTH OF WARRANTY

Replacement or repaired parts of products will be covered for the term of this warranty as stated in the following two sentences. If you are a consumer who purchased the product for use primarily for personal, family, or household purposes, this warranty extends for as long as you own the product and the home in which the product is installed. If you purchased the product for use primarily for any other purpose, including, without limitation, a commercial purpose, this warranty extends only (i) for 1 year, with respect to Interaktiv and Retroaktiv products, and (ii) for 5 years, with respect to AXQR, ShowerPower and Pharo products.

THIS WARRANTY DOES NOT COVER, AND HANSGROHE WILL NOT PAY FOR:

- A. Conditions, malfunctions or damage not resulting from defects in material or workmanship.
- B. Conditions, malfunctions or damage resulting from (1) improper installation, improper maintenance, misuse, abuse, negligence, accident or alteration, or (2) the use of abrasive or caustic cleaning agents or “no rinse” cleaning products, or the use of the product in any manner contrary to the product instructions.
- C. Labor or other expenses for the disconnection or return of the product for warranty service, or for installation or reinstallation of the product.
- D. Accessories or related products not manufactured by Hansgrohe.

TO OBTAIN WARRANTY SERVICE

Contact your Hansgrohe retailer, or write to Technical Service at:

Hansgrohe Inc.
1492 Bluegrass Lakes Parkway
Alpharetta GA 30004

Or, call Hansgrohe toll-free at (800) 334-0455.

In requesting warranty service, you will need to provide

- 1. The sales receipt or other evidence of the date and place of purchase.
- 2. A description of the problem.
- 3. Delivery of the product or the defective part, postage prepaid and carefully packed and insured, to Hansgrohe Inc. 1492 Bluegrass Lakes Parkway, Alpharetta, Georgia 30004, Attention: Technical Service, if required by Hansgrohe.

When warranty service is completed, any repaired or replacement product or part will be returned to you postage prepaid.

EXCLUSIONS AND LIMITATIONS

REPAIR OR REPLACEMENT (OR, IN LIMITED CIRCUMSTANCES, REFUND OF THE PURCHASE PRICE) AS PROVIDED UNDER THIS WARRANTY IS THE EXCLUSIVE REMEDY OF THE PURCHASER. HANSGROHE NEITHER ASSUMES NOR AUTHORIZES ANY PERSON TO CREATE FOR IT ANY OBLIGATION OR LIABILITY IN CONNECTION WITH THIS PRODUCT.

HANSGROHE SHALL NOT BE LIABLE TO PURCHASER OR ANY PERSON FOR ANY INCIDENTAL, SPECIAL, OR CONSEQUENTIAL DAMAGES, ARISING OUT OF BREACH OF THIS WARRANTY OR ANY IMPLIED WARRANTY (INCLUDING MERCHANTABILITY).

Some States do not allow the exclusion or limitation of incidental or consequential damages, so the above limitation or exclusion may not apply to you.

This warranty gives you specific legal rights, and you may have other rights which vary from State to State.

You may be required by law to give us a reasonable opportunity to correct or cure any failure to comply before you can bring any action in court against us under the Magnuson-Moss Warranty Act.

PRODUCT INSTRUCTIONS AND QUESTIONS

Upon purchase or prior to installation, please carefully inspect your Hansgrohe product for any damage or visible defect. Prior to installing, always carefully study the enclosed instructions on the proper installation and the care and maintenance of the product. If you have questions at any time about the use, installation, or performance of your Hansgrohe product, or this warranty, please call or write to us at the toll-free number and address printed above.

hansgrohe

Hansgrohe, Inc. • 1490 Bluegrass Lakes Parkway • Alpharetta, GA 30004
Tel. 770 360-9880 • Fax 770 360 9887

www.hansgrohe-USA.com