



### Features

- Integral flange.
- Right drain.
- Slotted overflow for deep soaking.
- Bask® heated surface creates spa-like relaxation with soothing warmth on your back, shoulders, and neck.
- VibrAcoustic® technology emits sound waves and offers a surround sound experience.
- Six transducers and a control amplifier with 25' (7.6 m) of wiring.
- High-resolution color screen in polished chrome.
- Integral apron with removable access panel.
- Integral lumbar support and armrests for comfort.
- Coordinates with other products in the Archer® collection.
- 66" (1676 mm) x 32" (813 mm) x 19" (483 mm)

### Material

- Acrylic

### Installation

- Alcove

### Required Accessories

K-7271 Brass Slotted Overflow Bath Drain

or

K-7272 PVC Slotted Overflow Bath Drain



### ADA

### Codes/Standards

CSA B45.5/IAPMO Z124

UL 1795

CSA C22.2 No. 218.2

Greenguard UL 2818 - Gold

ADA

ICC/ANSI A117.1











CARB P2

### KOHLER® One-Year Limited Warranty

See website for detailed warranty information.

### Available Color/Finishes

*Color tiles intended for reference only.*

Color	Code	Description
	0	White
	96	Biscuit
	47	Almond
	NY	Dune
	95	Ice™ Grey
	G9	Sandbar
	33	Mexican Sand™
	K4	Cashmere
	58	Thunder™ Grey
	7	Black Black™

No change in measurements if connected with drain illustrated. (K-7272)

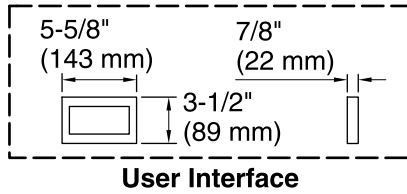

**User Interface**

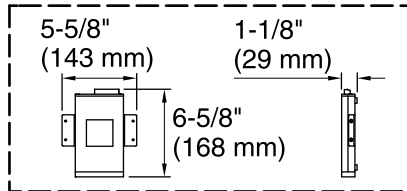

**Amplifier**

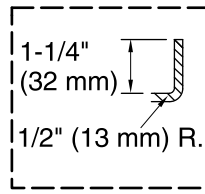

**Integral Flange Detail**

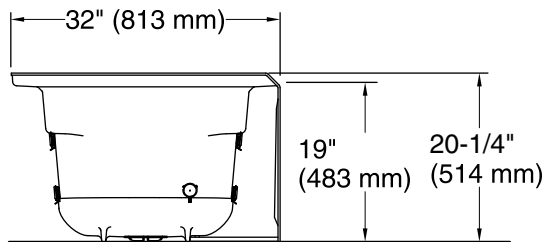
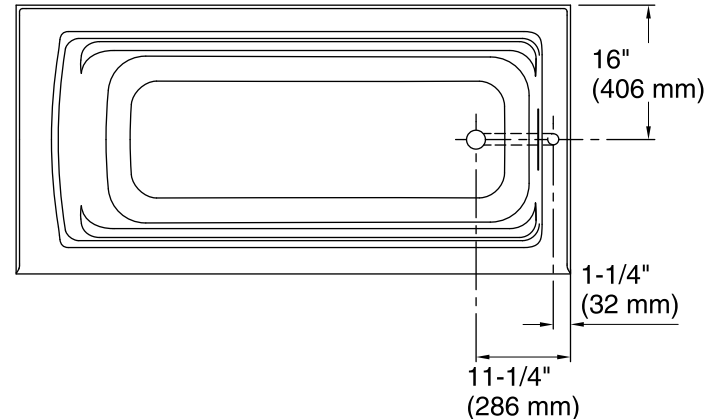

**\*Recommended User Interface Location**

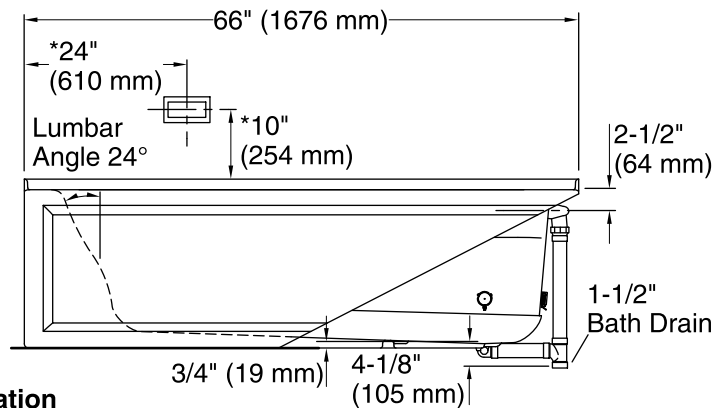

### Required Electrical Service

One circuit required, protected with Class A Ground-Fault Circuit-Interrupter (GFCI) or Residual Current Device (RCD).

Amplifier, Heated 120 V, 15 A, 50/60 Hz  
Surface:

### Technical Information

All product dimensions are nominal.

Installation:	3-Wall Alcove
Drain location:	Right
Basin area, bottom:	50-3/8" x 19-5/8" (1280 mm x 498 mm)
Basin area, top:	57-5/16" x 24-1/16" (1456 mm x 611 mm)
Weight:	85 lbs (38.6 kg)
Minimum floor load:	46 lbs/ft <sup>2</sup> (224.6 kg/m <sup>2</sup> )
Water depth:	15-5/16" (389 mm)
Water capacity:	66 gal (249.8 L)
Electrical component rating:	Amplifier: 120 V, 50/60 Hz Heated Surface: 120 V, 0.5 A, 50/60 Hz, 65 W
Minimum flat for door:	2-3/16" (55 mm)

### Notes

Measure your actual product for rough-in details.

Install this product according to the installation instructions.

The hot water supply should be 70% of the capacity of the bath or greater. Installations will vary.

Provide one grounded electrical outlet within 24" (610 mm) of each component.

Control amplifier fits 16" (406 mm) center studs. 25' (7.6 m) cables are included.

ADA compliant when installed to the specific requirements of these regulations.