



### Features

- Integral flange.
- Right drain.
- Integral lumbar support and armrests for comfort.
- Integral apron with removable access panel.
- Textured bottom surface.
- Coordinates with other products in the Devonshire® collection.
- 60" (1524 mm) x 32" (813 mm) x 20" (508 mm)

### Material

- Acrylic

### Hydrotherapy

- Single-speed whirlpool offers 8 fully adjustable hydro-massage jets for water flow and direction.
- Pump with air switch for whirlpool.

### Installation

- Alcove

### Recommended Accessories

- K-7161-AF Bath Drain
- K-24916 Wireless Music Kit
- K-7213 27" Cable Bath Drain
- K-7214 27" Cable Bath Drain
- K-7259 Clearflo Bath Drain
- K-37380 30" Rough-in Cable Bath Drain
- K-37383 30" Rough-in Cable Bath Drain
- K-702200-G54 Frameless Sliding Bath Door
- K-702200-G73 Frameless Sliding Bath Door
- K-702200-L Frameless Sliding Bath Door
- K-702205-L Frameless Sliding Bath Door



### Codes/Standards

- ASME A112.19.7/CSA B45.10
- CSA B45.5/IAPMO Z124
- ASTM E162
- ASTM E662
- UL 1795
- CSA C22.2 No. 218.2
- Greenguard UL 2818 - Gold





### KOHLER® One-Year Limited Warranty

See website for detailed warranty information.

### Available Color/Finishes

*Color tiles intended for reference only.*

| Color | Code | Description |
|-------|------|-------------|
|-------|------|-------------|

|                                                                                      |    |         |
|--------------------------------------------------------------------------------------|----|---------|
|  | 0  | White   |
|  | 96 | Biscuit |
|  | 47 | Almond  |
|  | NY | Dune    |
|  | G9 | Sandbar |

No change in measurements if connected with drain illustrated. (K-7161-AF)

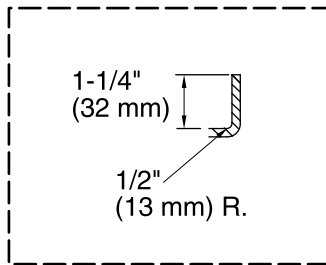

**Integral Flange Detail**

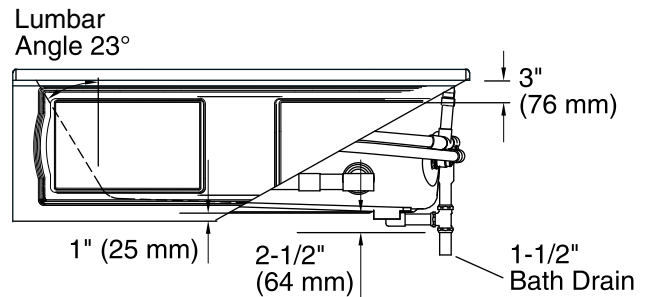
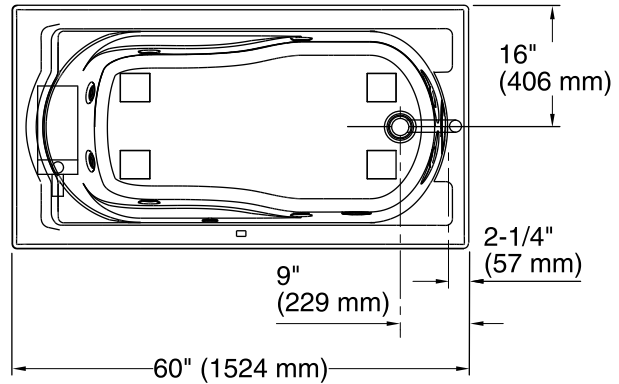
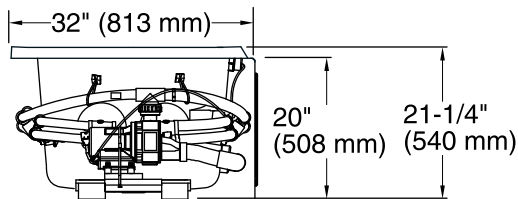

### Required Electrical Service

One dedicated circuit required, protected with Class A Ground-Fault Circuit-Interrupter (GFCI) or Residual Current Device (RCD).

Pump: 120 V, 15 A, 50/60 Hz

### Technical Information

All product dimensions are nominal.

Installation: 3-Wall Alcove

Drain location: Right

Basin area, bottom: 42" x 20" (1067 mm x 508 mm)

Basin area, top: 51" x 24" (1295 mm x 610 mm)

Weight: 135 lbs (61.2 kg)

Minimum floor load: 50 lbs/ft<sup>2</sup> (244.1 kg/m<sup>2</sup>)

Water depth: 14" (356 mm)

Water capacity: 60 gal (227.1 L)

Electrical component rating: Pump: 120 V, 7 A, 60 Hz

Minimum flat for door: 2-1/2" (64 mm)

### Notes

Measure your actual product for rough-in details.

Install this product according to the installation instructions.

The hot water supply should be 70% of the capacity of the bath or greater. Installations will vary.

Provide one grounded electrical outlet within 24" (610 mm) of each component.