

Fresh Living Tip

Design your own at-home spa experience by including wine storage near your soaking tub. At a compact 15" size, this model is a great solution to store your wine collection without dedicating a large footprint.

FINISH OPTIONS



15" Marvel High-Efficiency Single Zone Wine Refrigerator

MLWC215

Storage Adaptability

- 2.7 cu. ft. capacity stores 24 bottles of wine
- (6) 4-bottle wine racks
- Accommodates a variety of bottle sizes including champagne and magnum bottles
- ¾ extension smooth-glide ball-bearing shelving provides easy access to your collection
- Heavy-gauge wire wine racks safely cradle each wine bottle and prevent jarring

Performance

- Dynamic cooling technology delivers precise temperature stability and frost-free operation for an optimal wine preservation environment
- Proprietary shelving design allows temperature-controlled air to circulate throughout cabinet for consistency from top to bottom
- Vibration Neutralization System protects wine from agitation, allowing it to come to full maturation
- Thermal-efficient cabinet ensures optimum wine preservation and energy efficiency while maximizing capacity
- Argon-filled, UV-resistant tinted dual pane glass door protects contents from damaging ultraviolet light and helps conserve energy
- Sound-buffering design

Convenient Controls

- Multifunction controls allow you to select a precise cabinet temperature from 34° F to 60° F
- Features easy-to-use settings and options

Fit & Finish

- Elegant midnight black interior and arctic white LED interior lighting
- Solid natural maple shelf fronts, stainable to match cabinetry
- Reversible door allows for right or left swing for adaptable installation
- Black toe kick adjustable to 4" with leveling legs

Warranty

- 1-year parts and labor warranty and 5-year sealed system parts warranty



The energy- and space-efficient way to store fine vintage wines, this slim Marvel Wine Refrigerator stores 24 bottles in the optimum wine preservation environment.

DOOR STYLE

Stainless Steel Frame Glass

Panel Ready Frame Glass

Solid Panel Ready

Solid Stainless Steel

MODEL NUMBER

MLWC215-SG01A

MLWC215-IG01A

MLWC215-IS01A

MLWC215-SS01A



- 24-bottle capacity
- Reversible door
- Precise temp control
- Arctic white lighting
- Thermal-efficient finished cabinet design
- Heavy-gauge wire racking
- Fits magnum and champagne bottles
- ¾ extension smooth-glide shelving
- Vibration neutralization system

H: 33 3/4" W: 14 7/8" D: 26 7/32" (with handle)

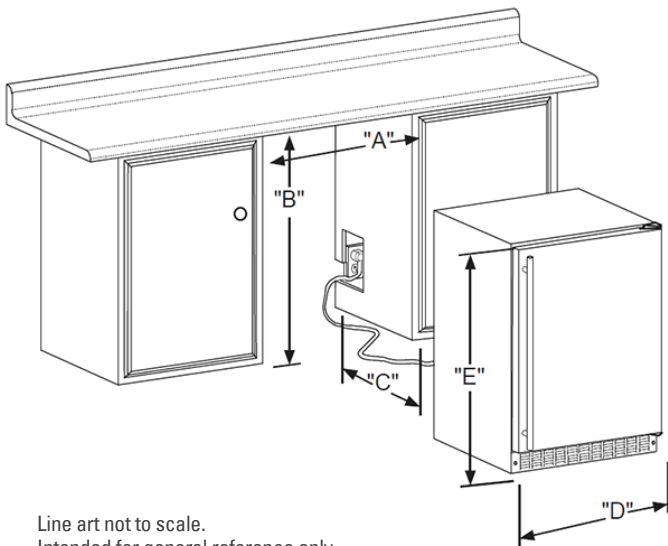

Line art not to scale.
Intended for general reference only.

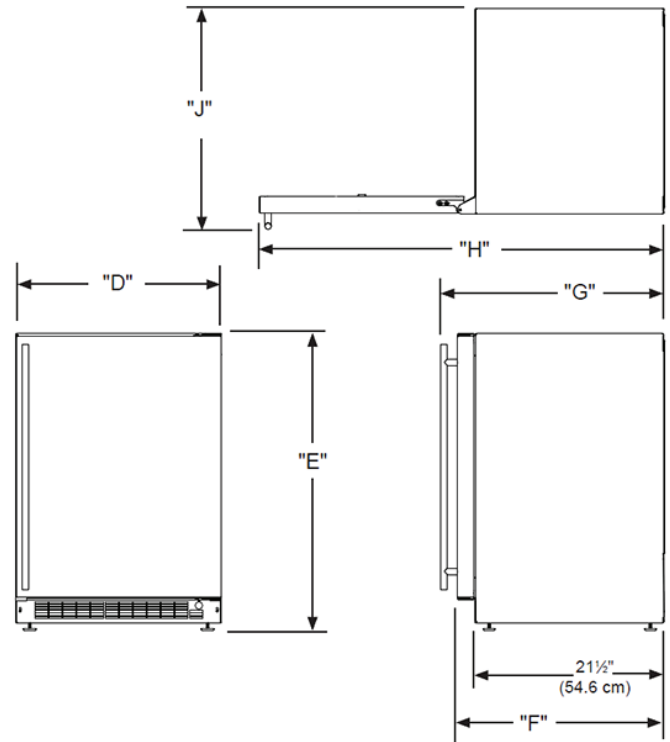

Rough In Dimensions*

"A"	"B"	"C"
15"	34-1/4" TO 35-1/4"	24"
(38.1 CM)	(87 CM TO 89.5 CM)	(61 CM)

Cabinet Dimensions*

"D"	"E"	"F"	"G"	"H"	"J"
14-7/8"	33-5/8" TO 34-5/8"	23-5/8"*	25-3/8"*	38-3/4"*	17-1/2"*
(37.8 CM)	(85.4 CM TO 87.9 CM)	(60 CM)	(64.4 CM)	(98.4 CM)	(44.4 CM)

*Stainless steel model dimensions only. For panel-ready models, see the owner's guide online at marvelrefrigeration.com.

- Capacity** 2.7 CU. FT.
- Control Type** Electronic
- Sabbath Mode** Yes
- Temperature Range** 34°F to 60°F
- Handle Style** Slim (handle not included on panel-ready models)
- Hinge Type** Reversible
- Interior Lighting** White LED
- Shelving System** ¾ Extension Smooth-Glide Wire Shelving
- Toe Grille Finish** Black

- Lock** No
- Electrical Requirements** 115V / 60 Hz / 15A
- Cord Length** 6 FT.
- Shipping Dimensions** 19" W x 31" D x 37" H
- Shipping Weight** 125 LBS
- Agency Approval** UL
- Refrigerant Type** R600a

For comprehensive installation instructions, including panel overlay details, please visit marvelrefrigeration.com to access the owner's guide.

