

Family: Pinnacle | Item No. 5252 AN/CM

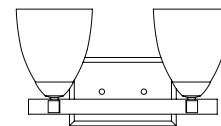

Drawing 1 - Strap Detail

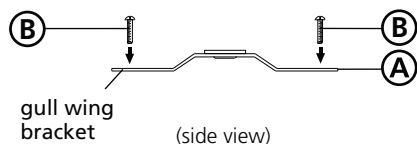

Drawing 2 - Fixture Mounting

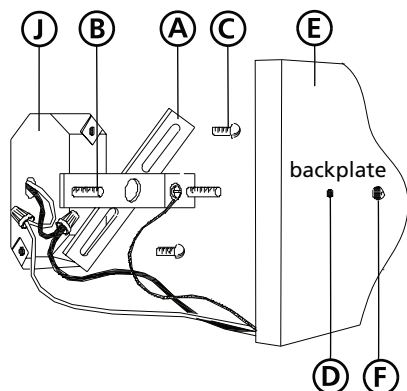

Drawing 3 - Glass Installation

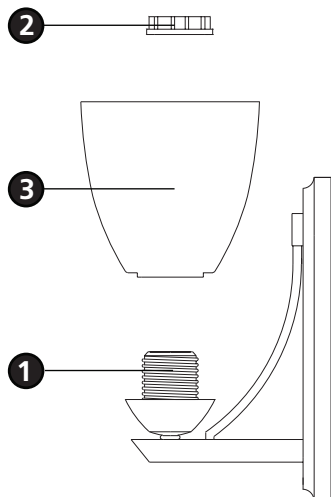

▼ start here

1

1. Find a clear area in which you can work.
2. Unpack fixture and glass from carton.
3. Carefully review instructions prior to assembly.

***** The construction of this fixture will be accomplished by first mounting the mounting strap to the junction box, making all necessary electrical connections, mounting the fixture to the wall, and then attaching the shade to the fixture.**

2

1. Prepare gem strap (A) for mounting by threading two screws (B) provided into back of gull wing bracket of gem strap (A) - see **Drawing 1**.
 - Be sure the holes into which the screws are threaded match the spacing of holes (D) in the back plate (E) - see **Drawings 1 and 2**.
3. Mount gem strap (A) to junction box (J), using the two 1" screws (C) provided.

SAFETY WARNING: READ WIRING AND GROUNDING INSTRUCTIONS (I.S. 18) AND ANY ADDITIONAL DIRECTIONS. TURN POWER SUPPLY OFF DURING INSTALLATION. IF NEW WIRING IS REQUIRED, CONSULT A QUALIFIED ELECTRICIAN OR LOCAL AUTHORITIES FOR CODE REQUIREMENTS.

3

Make electrical connections from supply wire to fixture lead wires. Refer to instruction sheet (I.S. 18) and follow all instructions to make all necessary wiring connections. Then refer back to this sheet to continue installation of this fixture.

4

1. Mount the fixture by slipping the holes (D) in the backplate (E) over the screws (B) in mounting strap (A) - see **Drawing 2**.
2. Thread on ball knobs (F) to secure fixture to the wall.

5

1. To install glass, remove socket ring (1) from the socket (2) - see **Drawing 3**.
2. Place glass (3) over socket (2).
3. Thread socket ring (1) back onto socket (2) and hand tighten.
Note: Using a tool or overtightening may cause glass damage.
4. Fixture can now be lamped accordingly.

Note: Maximum wattage for 5252 fixture is 100 watts per bulb.

12.30.08