

INSTALLATION INSTRUCTIONS

Item#921-695-L (New. 2023/02/16)

READ AND SAVE THESE INSTRUCTIONS

WARNING! SHUT POWER OFF AT FUSE OR CIRCUIT BREAKER.

AVERTISSEMENT! COUPER LE COURANT AU NIVEAU DES FUSIBLES OU DU DISJONCTEUR.

MOUNTING THE FIXTURE (Fig.1)

1. Shut off power at the fuse box or circuit breaker box and remove the old fixture including the mounting hardware.
2. Carefully unpack your new fixture and lay out all the parts in a clear area. Take care not to misplace any small parts necessary for installation.
3. Loosening screws (D) to remove mounting plate (A) from back plate (C). Position mounting plate (A) on the wall and mark the location for two drywall anchors (F). Pre-drill the holes for drywall anchors (F). Insert drywall anchors (F) into the wall.
4. Attach mounting plate (A) to the junction box (not included) using mounting screws (B). The side of mounting plate (A) marked "GND" must face out.
5. Screw wood screws (E) through the holes into drywall anchor (F) to secure mounting plate (A) as shown in Fig.1.

CONNECTING THE WIRES (Fig. 2)

6. Connect the electrical wires as shown in Fig. 2, making sure that all wire connectors are secured. If your junction box has a ground wire (green or bare copper), connect the fixture's ground wire to it. Otherwise, connect the fixture's ground wire directly to the mounting plate (A) using the green screw provided. After the wires are connected, tuck them carefully inside the junction box.

FINISHING THE INSTALLATION (Fig.1)

7. Place back plate (C) over mounting plate (A) and secure with screws (D).

Replacing LED module (Fig.3)

The LED module can be replaced by a qualified electrician without cutting of wire and without damage to any decorative element to which the fixture is attached. See installation steps for more details (Fig 3.)

- a. Shut off the power.
- b. To remove fixture from the wall, loosen screws (D) and back plate (C) from mounting plate (A). Disconnect wire connectors and place back plate (C) on a clean surface.
- c. Loosening screws (G), remove white faux alabaster (N) from back plate (C).
- d. Loosening screws (I) using wrench (J) (included), remove acrylic shade (M) from heating panel (H).
- e. Press the button on printed "L" quick connector on LED module (K) with screwdriver (not included) to disconnect the black wire. Repeat by pressing the button on printed "N" quick connector on LED module (K) to disconnect the white wire.
- f. Loosening screws (L) and remove LED module (K) from back plate (C).
- g. Reverse steps b-f for installing the new LED module.

Note: Illustration (Fig. 1) on this manual is for installation purposes only. It may or may not be identical to the fixture purchased.

Dimmable with ELV and/or LED compatible wall dimmer switches.

Fig. 1

Set#A-021-118360
-Mounting Screw*2
-Ground Screw
-Mounting Plate

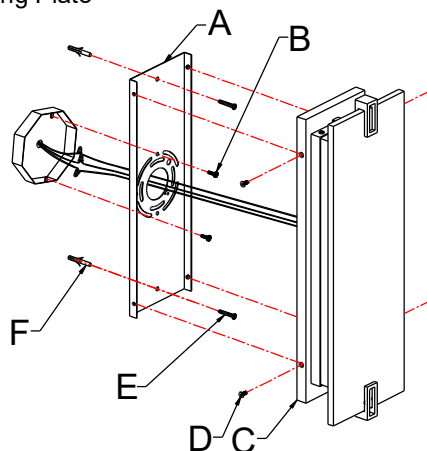

Fig. 2

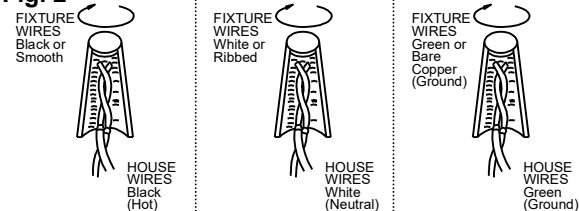

Fig. 3

