

INSTALLATION INSTRUCTIONS
HOT / COLD WATER DISPENSER
Model No: 106, 107, 107x, 108, 108x
2470-5603

NEWPORT BRASS®
Flawless Beauty. From Faucet to Finish.™

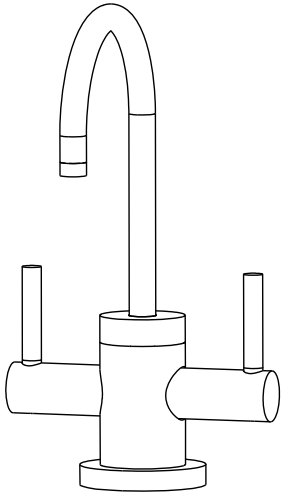

106

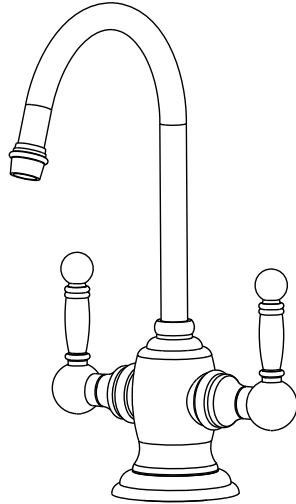

107

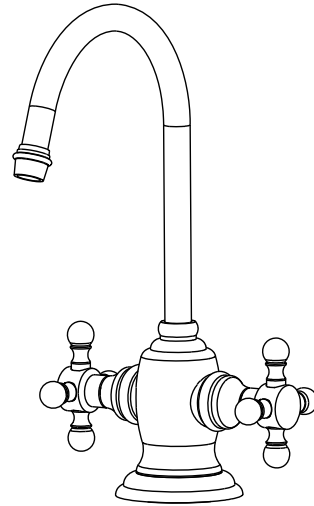

107X

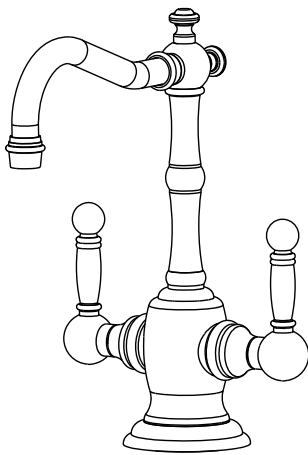

108

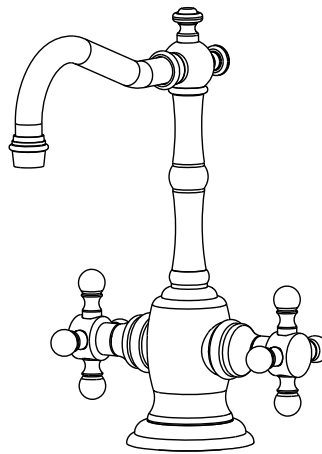

108X

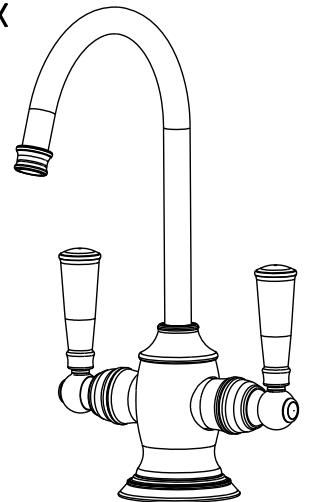

2470-5603

**Congratulations on the purchase
of this Brasstech product,
an excellent choice that will give you**

IMPORTANT PRODUCT INFORMATION

Brasstech water dispensers are tested and warranted only when connected to Brasstech water heater 5-036.

Under normal operation, Brasstech's line of 'Hot' and 'Hot/Cold' water dispensers may drip for a period of up to 15 minutes after each use. This condition originates from the unit's integral hot water tank. It is caused by the thermal expansion of water occurring naturally when cool water is heated in a confined space (the tank). Brasstech dispensers were specifically designed to allow steam or any amount of water expansion to escape through the spout, thus preventing dangerous high pressure from building up inside the tank. This is a safety feature; not to be confused with a defective product.

Lab tests have confirmed that during the heat up cycle, water may leak from the spout for up to 15 minutes after the valve is shut off. This duration varies based on the hot water tank's temperature setting and amount of hot water consumed. Approximate volume of water expansion during the 10-15 minute period is 3-5 ounces.

Although persistent leaking and/or dripping may be caused by a non-conforming cartridge and/or improper assembly, the type of leakage described here (10-15 min., 3-5 oz) can be verified by unplugging the power to the water heater. There should be no leak through the spout after the hot valve is shut off in this manner.

Recommended Installation by a Professional Plumbing Contractor

Note: The use of petroleum base plumbers putty on our products will nullify the warranty. We recommend the use of clear silicone sealing materials. Recommended deck thru hole \varnothing 1.25" to \varnothing 1.38

INSTALLING FAUCET ON SINK (See Fig 1)

- Slide the 3 hoses through escutcheon, o-ring, and mounting surface hole.
- Tightening flange nut on underside of mounting surface to secure into place.

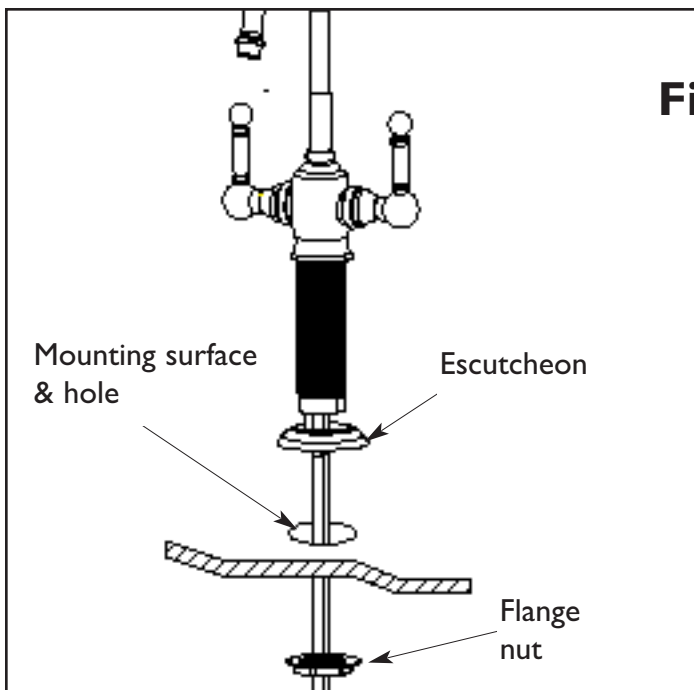
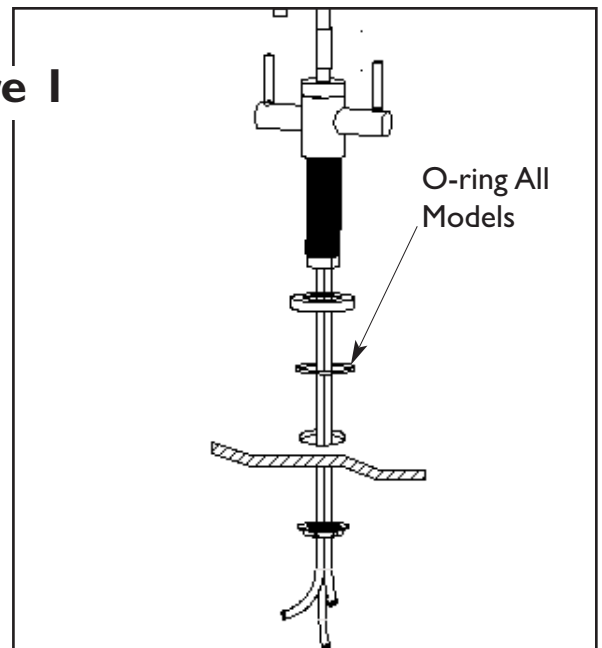
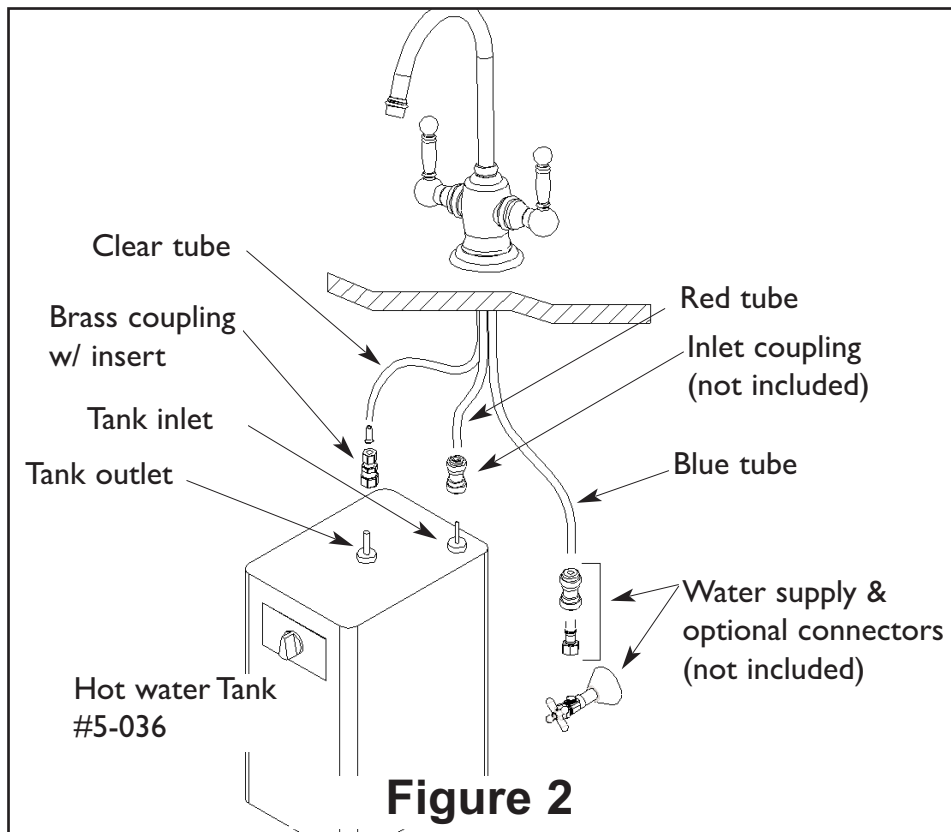

Figure 1



ATTACHING WATER CONNECTIONS TO SUPPLY AND TANK (See Fig 2)

- Connect blue tube to copper tubing of water supply, utilizing a compression nut or connector coupling (not included).
- Connect clear tube to heater tank outlet, utilizing brass coupling & insert.
- Connect red tube to heater tank inlet, utilizing connector coupling (not included).



3. TEST INSTALLED FAUCET

- Turn on water supply. Rotate the hot handle and hold until the tank fills up, (tank is full when water comes out of the spout). Rotate hot handle to turn water off.
- Check all connections for leaks. Make any final adjustments as required by first turning off the water supply to relieve the pressure.
- Plug in the water tank and wait between 10-15 minutes for water to reach its target temperature.