

Baldwin Hardware Corporation



Baldwin 2-1/2 and 2-3/4 backset Mortise locks are designed for residential use in UL-listed fire-rated openings rated for 3-hour maximum. Meets U.S. UL10C (positive pressure) and CANS-104M80. In the event of fire, lock will be permanently disabled when mechanism reaches temperatures above 400°F. Use in accordance with local fire code regulations.

Mortise Lock Installation Instructions

TOOLS REQUIRED

- | | | | |
|---|--|----|--|
| 1 | Pencil | 9 | Combination Square |
| 2 | No. 2 and No. 3 Phillips Head Screwdrivers | 10 | Awl |
| 3 | No. 1 and No. 2 Slotted Screwdrivers | 11 | Hacksaw |
| 4 | 1/8" Allen Head Wrench | 12 | File (Wood Rasp and Metal) |
| 5 | 3/4" Wood Chisel or Corner Chisel | 13 | Baldwin Aligning Tool |
| 6 | Measuring Device | 14 | Drill and assorted Drill Bits (1/16", 1/8", 5/16", 3/8", 3/4", 1", 1-1/4") |
| 7 | Lock Mortising Tool (Recommended) | 15 | Screw Wax or Soap |
| 8 | Router and Lock Face Template | 16 | Powder Chalk, Graphite or Lipstick |

Note: In order to successfully install a mortise lock and trim, a minimum of average skill level is required with use of the above listed tools.

Read and understand the provided instructions BEFORE attempting to mark or cut the door and/or frame. If there are any questions before you begin the installation, phone or visit your nearest Baldwin Distributor or contact the Technical Service Department at Baldwin at 610.777.7811.

Diagram A

ENTRANCE HANDLESET

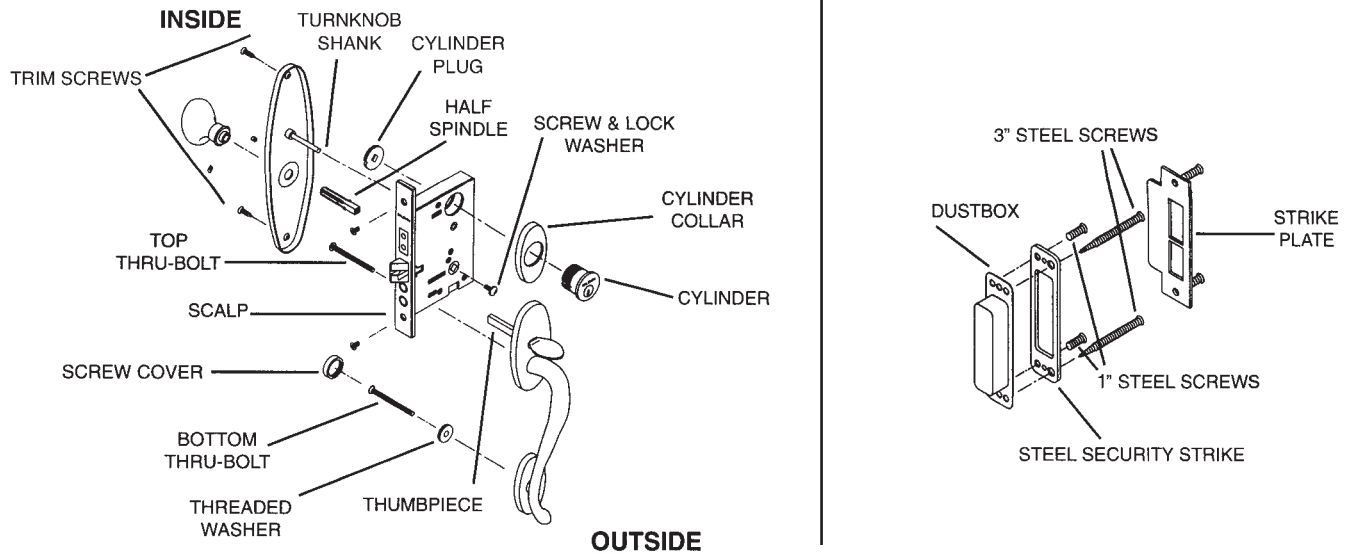
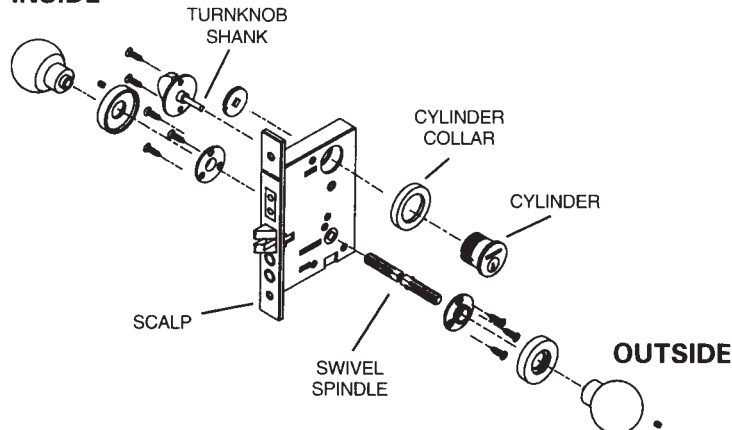
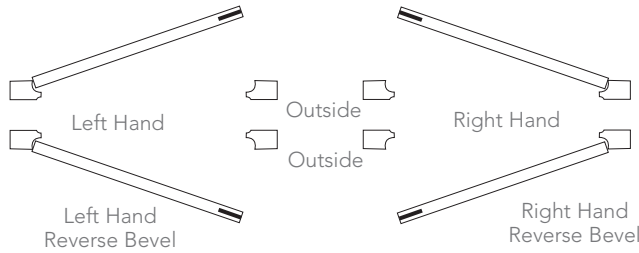

Diagram B

ENTRANCE LEVER/KNOB SET



DOOR CONDITIONS



HAND OF DOOR IS ALWAYS DETERMINED FROM THE OUTSIDE

Here are some rules to follow:

- The outside of an exterior door is the street or entrance side.
- The outside of a room is the hall side.
- The outside of a single communicating door is the side from which the hinges are not visible when the door is closed.
- The outside of a closet door is the room or hall side.

GENERAL NOTES

Paper template is designed for 1-3/4" thick doors. For extra thick doors, measure backset from center of door edge. Tape supplied template to the door to locate fastener pattern for lock and trim.

When installing hardware on metal or fiberglass doors, ensure the door was designed to accommodate mortise locks. If in doubt, check with your local door distributor or door manufacturer.

Removal of hardware from doors is recommended before painting and finishing of the door. Allow paint/stain to fully cure before reinstalling hardware, usually ten days to two weeks. Check paint manufacturer instructions.

Retain these instructions in a safe place should you need to disassemble the lock trim or require Baldwin's assistance.

Mortise Lock Handleset Installation Instructions

1 Mark the Door



Mark the door at 37-1/2" - 40" above finished floor, or if retrofit, at appropriate location to coordinate with existing strike preparations. This will be center line of the lock and will put the knob/lever at 36" - 39" above the floor.

2 Double Check Compatibility of Door Stile & Trim

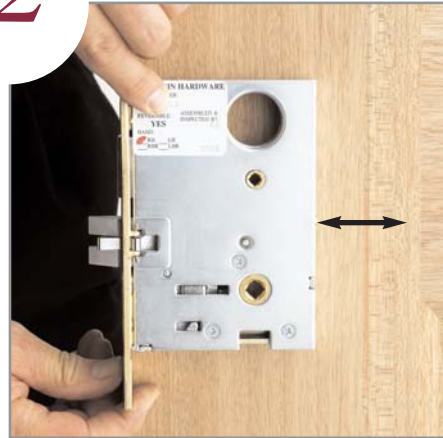

Make sure that the door stile will accommodate the intended lock.

3 Determine Hole Pattern Required for Trim on Blue Sheet

BALDWIN INSTALLATION TEMPLATE FOR RESIDENTIAL AND LISTED MORTISE

Go down left-hand column to find your Lock Number. Read across the page to determine yellow Template enclosed to be used to transfer the hole pattern to the door.

| 6800 SERIES LOCKS | 6800 SERIES LOCKS | 6800 SERIES LOCKS | 6800 SERIES LOCKS | DOOR PREP | TRIM | TRIM |
|-------------------|-------------------|-------------------|-------------------|-----------|-------|------|
| 6800 | 6800 | 6800 | 6800 | | | |
| 6801 | 6801 | 6802 | 6800 | INSIDE | 3-4 | 6842 |
| | | | | OUTSIDE | 2-4 | 6846 |
| 6875 | 6875 | | | INSIDE | 3-4 | 6872 |
| | | | | OUTSIDE | 2-4 | 6876 |
| 6877 | | | | INSIDE | 3-4 | 6880 |
| | | | | OUTSIDE | 2-4 | 6884 |
| 6880 | | | | INSIDE | 2-4 | 6888 |
| | | | | OUTSIDE | 2-4 | 6892 |
| 6805 | 6805 | 6807 | 6805 | INSIDE | 2-4 | 6896 |
| | | | | OUTSIDE | 2-4 | 6900 |
| 6810 | 6810 | 6812 | 6810 | INSIDE | 3-4 | 6904 |
| | | | | OUTSIDE | 2-4 | 6908 |
| 6891 | | | | INSIDE | 3-4 | 6912 |
| | | | | OUTSIDE | 2-4 | 6916 |
| 6896 | | | | INSIDE | 3-4 | 6920 |
| | | | | OUTSIDE | 2-3-4 | 6924 |

Determine hole pattern required for trim using **Installation Template Guide Chart** (blue sheet shown). Mark the listed holes on the **yellow lock template** (figure 7) enclosed with the lock. Ensure trim will not interfere with door stop or extend over door panel or glass.

4 Mortise Lock Pocket For Lock Body



Mortise the pocket in the door 1/8" deeper than the lock being installed. Refer to the **Installation Template Guide Chart** (blue sheet) for exact size of mortise pocket.

5^A Prepare for Lock Front



Rout for the lock front.

5^B Prepare for Lock Front



Square the Corners.

6 Cut Relief Pockets



Cut the relief pockets 3/8" deep on both sides for the Latch Hinge, 2-1/2" and 2-3/4" backset only. (Does not apply for 1" front.)

7 Mark Door

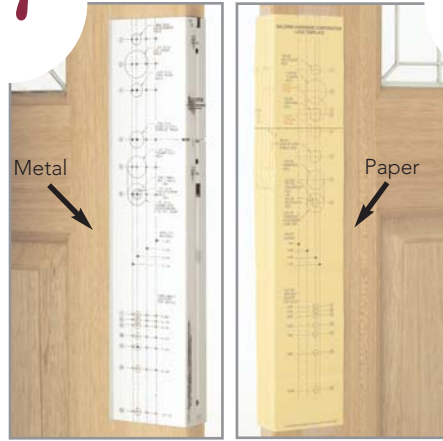

For 1-3/4" doors, fold the **yellow lock template** and attach to door using [Installation Template Guide](#). Mark door at appropriate locations for lock and trim. **MARK APPROPRIATE BACKSET.**
(Extra thick door conditions, see General Notes.)
Metal template 8498.000 is available for purchase.

8 Drill Holes



Drill appropriate holes as indicated on yellow lock template. **DO NOT OVERSIZE HOLES.** Only top two holes are drilled for knob to knob and lever to lever sets.

9 Install Cylinder Plug



Thread the cylinder plug into interior side of lock. Place a strip of tape over plug to keep it from turning. Notch must be located as shown. (Double cylinder functions: OMIT THIS STEP.)

10 Install Lock



Drill two pilot holes for the lock face, adjust the bevel and install the lock. Shim between the lock and door on cylinder side as shown to prohibit the cylinder from pulling the lock case off center. (Failure to shim the lock may cause the cylinder to sit unevenly on the surface of the trim.)

11 Insert Spindle



For handleset trim install the spindle from the inside with V groove facing bottom door hinge and thread the screw and lock washer into the spindle from the outside. Tighten securely. For knob to knob and lever to lever sets, install spindle from outside - go to step 13.

12 Size Thumbpiece



Cut the thumbpiece so that it will fully engage the lift lever on the bottom of the lock.

13 Install Cylinder



Place the cylinder through the trim. Partially insert key into cylinder. Thread the cylinder into the lock until it is against the trim and Baldwin name is horizontal. For knob to knob and lever to lever sets - Install aligning bushing and fasten trim with supplied screws. Remove bushing - go to step 16.

14 Install Thru-Bolts



Start the thru-bolts which will hold the exterior trim. (Use screw cover washer under the bottom thru-bolt.) Tighten both securely.

15

Size & Cut Thumbturn

Cut the thumbturn tailpiece so that it goes halfway through the lock (as in step 12).

16

Install Interior Trim

Place the interior trim on the door. Slide the aligning bushing onto the spindle so it fits into the knob hole. Drill pilot holes and fasten interior trim with supplied fasteners. Remove bushing and discard.

17

Complete Trim Installation

Start the set screw before sliding the knob or lever onto the spindle. Slide knob or lever onto the spindle and tighten securely. For knob to knob and lever to lever sets - install both sides - go to step 19.

18

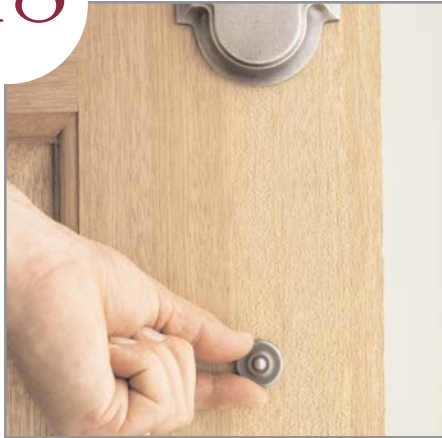
Install Screw Cover

Thread decorative screw cover onto threaded washer.

19

Tighten Cylinder Set Screw

Tighten the cylinder set screw by turning clockwise. **Do not over tighten. Do not use a power screw driver.**

20

Install Armor Front

Install the armor front with the small phillips head screws supplied.

21

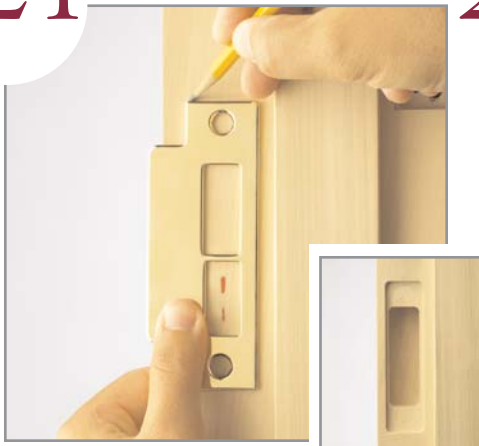
***Mark and Mortise Jamb for Strike Location**

Mark the Jamb for the proper strike location. Coat extended latch bolt with graphite, powdered chalk or lipstick. Retract the bolt, close the door and actuate the knob or lever several times to mark the jamb. Add approximately 1/32" clearance from that mark.

22

Install Dust Box & Security Strike

Drill pilot holes for security strike and relief holes for finished strike. Install dust box and security strike with 1" and 3" screws on the stop side of the plate. *Note: Security Strikes are supplied only with locks which utilize cylinders.*

23

Install Strike Plate

Install strike plate with supplied machine screws.

*** APPLY ANY WEATHERSTRIPPING BEFORE STRIKE HAS BEEN INSTALLED.**