

USER GUIDE & SERVICE MANUAL

SAFETY • INSTALLATION & INTEGRATION • OPERATING INSTRUCTIONS • MAINTENANCE • SERVICE



 **U-LINE**
RIGHT PRODUCT. RIGHT PLACE. RIGHT TEMPERATURE. SINCE 1962.

2000 Series • 2224DWR • 24" Drawer Model

Tip: Click on any section below to jump directly there

Contents

Intro

Safety

Safety and Warning

Disposal and Recycling

Installation

Environmental Requirements

Electrical

Cutout Dimensions

Product Dimensions

Anti-Tip Bracket

General Installation

Integrated Grille / Plinth Dimensions

Grille / Plinth Installation

Drawers

Operating Instructions

First Use

Control Operation

Sabbath Mode

Airflow and Product Loading

Maintenance

Cleaning

Cleaning Condenser

Extended Non-Use

Service

Troubleshooting

Warranty

Service Extended

Wire Diagram

Product Liability

Warranty Claims

Parts

Ordering Replacement Parts

System Diagnosis Guide

Compressor Specifications

Troubleshooting Extended

Control Quick Guide

Thermistor

Defrost

Remove Fan and Cover

WELCOME TO U-LINE

Congratulations on your U-Line purchase. Your product comes from a company with over five decades of premium modular ice making, refrigeration, and wine preservation experience. U-Line continues to be the American leader, delivering versatility and flexibility for multiple applications including residential, light commercial, outdoor and marine use. U-Line's complete product collection includes Wine Captain® Models, Beverage Centers, Clear Ice Machines, Crescent Ice Makers, Glass & Solid Door Refrigerators, Drawer Models, Freezers, Combo® Models, and more.

U-Line has captivated those with an appreciation for the finer things with exceptional functionality, style, inspired innovations and attention to even the smallest details. We are known and respected for our unwavering dedication to product design, quality and selection. U-Line is headquartered in Milwaukee, Wisconsin and has shipped product to five continents for over two decades and is proud to have the opportunity to ship to you.

PRODUCT INFORMATION

Looking for additional information on your product? User Guides, Spec Sheets, CAD Drawings, Compliance Documentation, and Product Warranty information are all available for reference and download at u-line.com.

PROPERTY DAMAGE / INJURY CONCERNS

In the unlikely event property damage or personal injury is suspected related to a U-Line product, please take the following steps:

1. U-Line Customer Care must be contacted immediately at +1.800.779.2547.
2. Service or repairs performed on the unit without prior written approval from U-Line is not permitted. If the unit has been altered or repaired in the field without prior written approval from U-Line, claims will not be eligible.

GENERAL INQUIRIES

U-Line Corporation
8900 N. 55th Street
Milwaukee, Wisconsin 53223 USA
Monday - Friday 8:00 am to 4:30 pm CST
T: +1.414.354.0300
F: +1.414.354.7905
Email: sales@u-line.com
u-line.com

SERVICE & PARTS ASSISTANCE

Monday - Friday 8:00 am to 4:30 pm CST
T: +1.800.779.2547
F: +1.414.354.5696
Service Email: onlineservice@u-line.com
Parts Email: onlineparts@u-line.com

CONNECT WITH US



Designed, engineered and assembled in WI, USA

Safety and Warning

NOTICE

Please read all instructions before installing, operating, or servicing the appliance.

Use this appliance for its intended purpose only and follow these general precautions with those listed throughout this guide:

SAFETY ALERT DEFINITIONS

Throughout this guide are safety items labeled with a Danger, Warning or Caution based on the risk type:



DANGER

Danger means that failure to follow this safety statement will result in severe personal injury or death.



WARNING

Warning means that failure to follow this safety statement could result in serious personal injury or death.



CAUTION

Caution means that failure to follow this safety statement may result in minor or moderate personal injury, property or equipment damage.



DANGER

This unit contains R600a (Isobutane) which is a flammable hydrocarbon. It is safe for regular use. Do not use sharp objects to expedite defrosting. Do not service without consulting the “R600a specifications” section included in the User Guide. Do not damage the refrigerant circuit.



WARNING

Service must be done by factory authorized service personnel. Any parts shall be replaced with like components. Failure to comply could increase the risk of possible ignition due to incorrect parts or improper service.

Disposal and Recycling

 **DANGER**

RISK OF CHILD ENTRAPMENT. Before you throw away your old refrigerator or freezer, take off the doors and leave shelves in place so children may not easily climb inside.

If the unit is being removed from service for disposal, check and obey all federal, state and local regulations regarding the disposal and recycling of refrigeration appliances, and follow these steps completely:

1. Remove all consumable contents from the unit.
2. Unplug the electrical cord from its socket.
3. Remove the door(s)/drawer(s).

Environmental Requirements

This model is intended for indoor/interior applications only and is not to be used in installations that are open/exposed to natural elements.

This unit is designed to operate between 50°F (10°C) and 100°F (38°C). Higher ambient temperatures may reduce the unit's ability to reach low temperatures and/or reduce ice production on applicable models.

For best performance, keep the unit out of direct sunlight and away from heat generating equipment.

In climates where high humidity and dew points are present, condensation may appear on outside surfaces. This is considered normal. The condensation will evaporate when the humidity drops.



Damages caused by ambient temperatures of 40°F (4°C) or below are not covered by the warranty.

Electrical



SHOCK HAZARD — Electrical Grounding Required. Never attempt to repair or perform maintenance on the unit until the electricity has been disconnected.

Never remove the round grounding prong from the plug and never use a two-prong grounding adapter.

Altering, cutting or removing power cord, removing power plug, or direct wiring can cause serious injury, fire, loss of property and/or life, and will void the warranty.

Never use an extension cord to connect power to the unit.

Always keep your working area dry.

NOTICE

Electrical installation must observe all state and local codes. This unit requires connection to a grounded (three-prong), polarized receptacle that has been placed by a qualified electrician.

The unit requires a grounded and polarized 115 VAC, 60 Hz, 15A power supply (normal household current). An individual, properly grounded branch circuit or circuit breaker is recommended. A GFCI (ground fault circuit interrupter) is usually not required for fixed location appliances and is not recommended for your unit because it could be prone to nuisance tripping. However, be sure to consult your local codes.

See CUTOUT DIMENSIONS for recommended receptacle location.

Cutout Dimensions

PREPARE SITE

Your U-Line product has been designed exclusively for a built-in installation. When built-in, your unit does not require additional air space for top, sides, or rear. However, the front grille must NOT be obstructed.

The product is designed and manufactured for seamless integration in the specified cutout opening shown, which requires precise measurements. The opening must be square and plumb front to back. Although not required, you may choose to increase the overall cutout width for ease of installation.

The Modular 3000 Series units are engineered with a variety of adjustment features to help ensure a seamless installation. Adjustable doors, leveling legs and grille will assist in fine tuning the installation.

All 3000 Series models fully integrate into overlay/face frame, inset or European/frameless cabinet styles and install seamlessly into standard 24" (610 mm) depth cabinet base.



Unit can NOT be installed behind a closed cabinet door.

CUTOUT DIMENSIONS

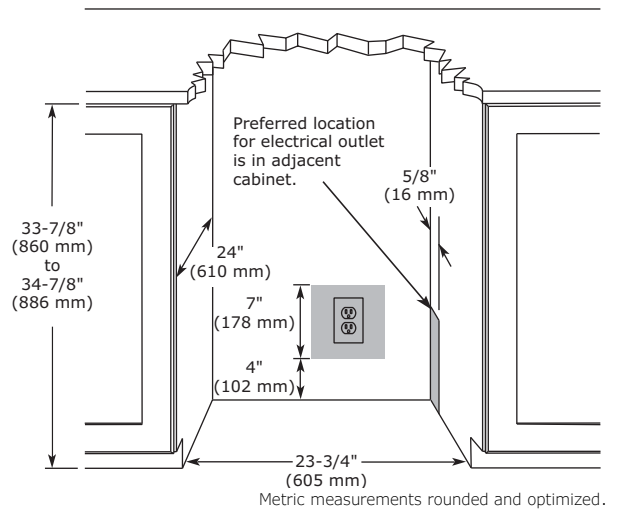

Product Dimensions

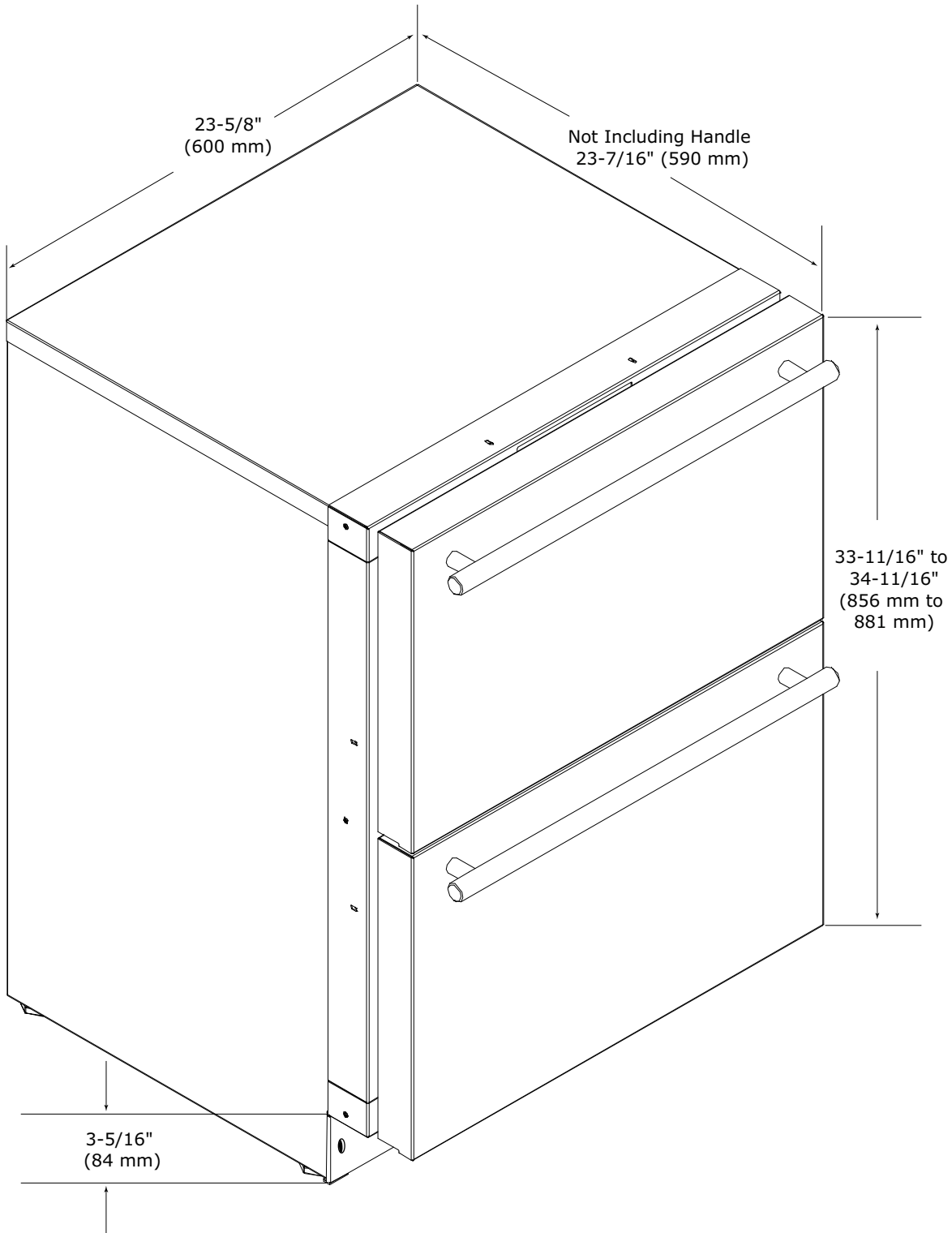

Anti-Tip Bracket



The anti-tip bracket must be installed to prevent the unit from tipping when doors are fully opened or excess weight is placed on the front of the unit.

The anti-tip bracket has multiple mounting options. Mounting will depend on your particular cabinet configuration. Locate 3 #8x5/8" screws included with your unit.

TOP MOUNT

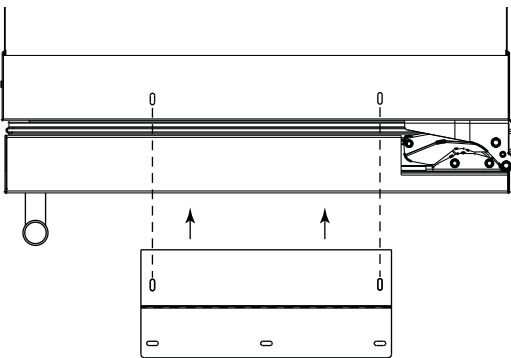

For ease of installation, the anti-tip bracket is pre-installed in the top mount position.

1. Completely slide the unit into its position in the cabinet. Be certain unit height is properly adjusted. (See GENERAL INSTALLATION).
2. Open door completely. Make certain door clears surrounding cabinetry.
3. Using a 3/32" (2.50 mm) drill bit, drill 3 pilot holes 5/8" (16 mm) deep into bottom of counter top. Use the anti-tip bracket as a template.
4. Install 3 #8x5/8" screws into the plate using a #2 Phillips head screwdriver.

SIDE MOUNT

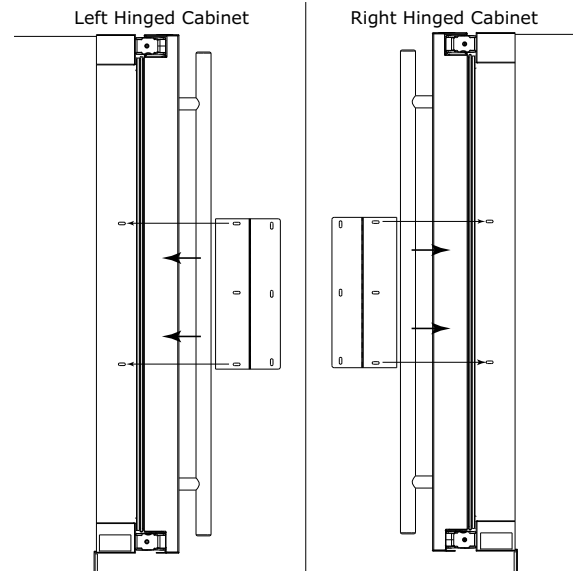

Side mount position is used when you are unable to mount the bracket to the underside of your countertop.

1. Remove the pre-installed anti-tip bracket from the top mount position and align the bracket to the hinge side of the unit as shown above.
2. Reinstall the 2 #8x5/8" screws into the plate using a #2 Phillips head screwdriver.
3. Completely slide the unit into its position in the cabinet. Be certain unit height is properly adjusted. (See GENERAL INSTALLATION).
4. Open door completely. Make certain door clears surrounding cabinetry.
5. Using a 3/32" (2.50 mm) drill bit, drill 3 pilot holes 5/8" (16 mm) deep into cabinetry frame using the anti-tip bracket as a template.
6. Install 3 #8x5/8" screws into the plate using a #2 Phillips head screwdriver.

General Installation

1. Use a level to confirm the unit is level. Level should be placed along top edge and side edge as shown.

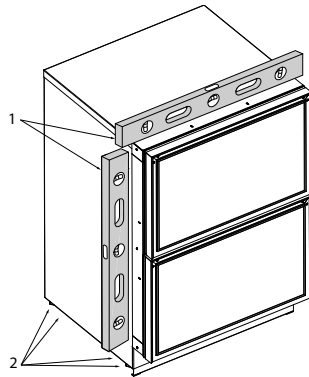

2. If the unit is not level, remove grille and adjust legs as necessary. Use included tool to adjust the height of the legs.

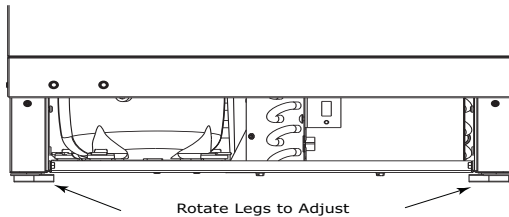

3. Confirm the unit is level after each adjustment and repeat the previous steps until the unit is level.

INSTALLATION TIP

If the room floor is higher than the floor in the cutout opening, adjust the rear legs to achieve a total unit rear height of 1/8" (3 mm) less than the opening's rear height. Shorten the unit height in the front by adjusting the front legs. This allows the unit to be gently tipped into the opening. Adjust the front legs to level the unit after it is correctly positioned in the opening.

INSTALLATION

1. Plug in the power/electrical cord.
2. Gently push the unit into position. Be careful not to entangle the cord.
3. Re-check the leveling, from front to back and side to side. Make any necessary adjustments. The unit's top surface should be approximately 1/8" (3 mm) below the countertop.
4. Install the anti-tip bracket.
5. Remove the interior packing material and wipe out the inside of the unit with a clean, water-dampened cloth.

Integrated Grille - Plinth Dimensions

PREPARE AND INSTALL INTEGRATED GRILLE (PLINTH STRIP/BASE FASCIA)

1. Use the dimensions provided in the diagram to cut and shape your integrated grille (plinth strip/base fascia) panel. Recommended panel thickness is between 1/4" (6 mm) and 3/8" (9 mm).
2. Finish or stain your grille (plinth strip/base fascia) panel to match your surrounding furniture. Finish front, back and edges to prevent warping. Carefully follow the manufacturer's recommendations for finish application and cure times.
3. Apply double sided tape to the backside of the integrated grill (plinth strip/base fascia). Use the diagram below for reference. U-Line recommends 3M™ VHB™ tape, a high strength bonding tape.

Apply Tape To Shaded Area



4. Remove backing paper from double sided tape.
5. Carefully align grille (plinth strip/base fascia) over integrated panel and press into position.

INTEGRATED GRILLE (PLINTH STRIP/BASE FASCIA) DIMENSIONS

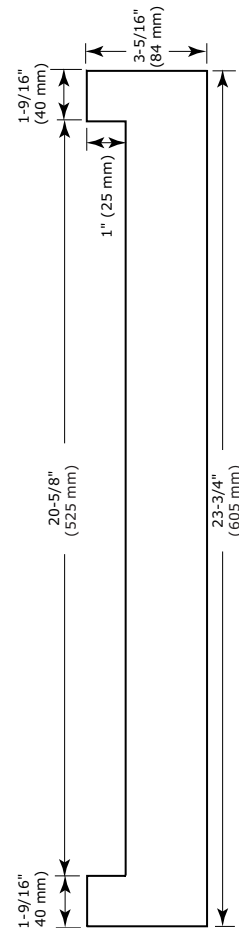

Grille - Plinth Installation

REMOVING AND INSTALLING GRILLE (PLINTH STRIP/BASE FASCIA)



Disconnect electric power to the unit before removing the grille (plinth strip/base fascia).

When using the unit, the grille (plinth strip/base fascia) must be installed.



DO NOT touch the condenser fins. The condenser fins are SHARP and can be easily damaged.

Removing the grille (plinth strip/base fascia)

1. Disconnect power to the unit.
2. Loosen the two screws (1).
3. Remove grille (plinth strip/base fascia) (2) from unit.

Installing the grille

1. Align cabinet and grille holes and secure, but do not over tighten grille (plinth strip/base fascia) screws (1).
2. Reconnect power to the unit.

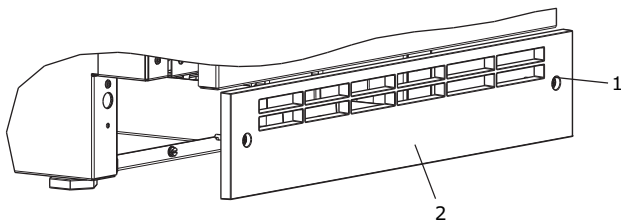

Drawers

CHECKING DRAWER ALIGNMENT

The unit's drawers are aligned at the factory before shipment. However, their alignment could have been disturbed during shipment or during overlay panel installation. Check each drawer to confirm that it is aligned:

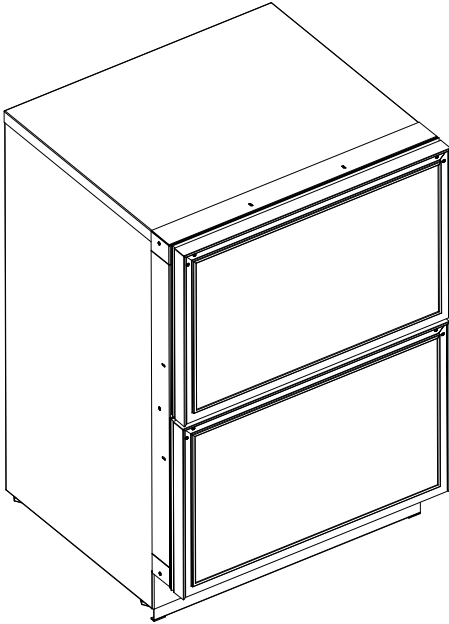

- **Side-to-Side** — When viewed from the top, the drawer front should be square with the sides of the cabinet.
- **Front-to-Back** — When viewed from the side, the drawer front should be straight with the cabinet's sides, not cocked forward or back.
- **Top-to-Bottom** — When viewed from the front, the drawer should be level horizontally.

ADJUSTING DRAWER ALIGNMENT



SHOCK HAZARD — The unit must be unplugged from the wall outlet during drawer removal, adjustment and re-installation.

DRAWER REMOVAL

1. Confirm that the unit is unplugged from wall outlet
2. Remove the mounting screws.
3. Pull the drawer completely out of the unit.

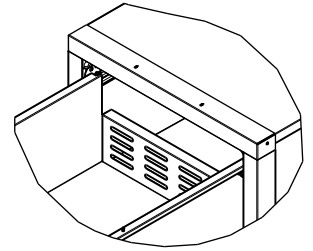

Use care when handling the drawer. Drawer edges, drawer rail and the unit's slide may be sharp.

NOTICE

Drawer adjustments are made by moving the slide that carries the drawer's rail. Minor adjustments may be made by loosening one of the slide's mounting screws, adjusting the slide and retightening the screw. Severe adjustments may be made by removing the slides' mounting screws, drilling new mounting holes and remounting the slide.

SIDE-TO-SIDE ADJUSTMENT

The drawer will need a Side-to-Side Adjustment if, when viewed from the top, the drawer front is not square with the sides of the cabinet. This is caused by one of the slides being mounted too far forward on the unit's liner.

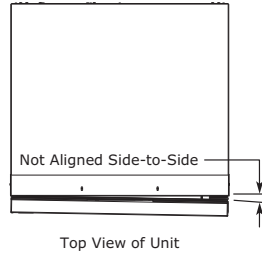

Minor Adjustment:

Note: The mounting holes on the slide are slightly larger than the screws' diameter.

1. Loosen the slide's mounting screws.
2. Push the slide backward.
3. Retighten the screws.

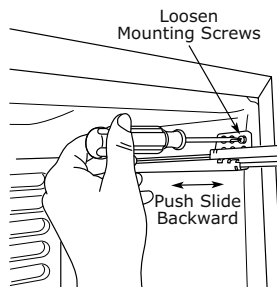

Severe Adjustment:

Note: The slides have extra mounting holes that may be used.

1. Remove the slide's mounting screws.
2. Reposition the slide so it is the same distance from the front of the liner as the other slide. Measure to confirm.

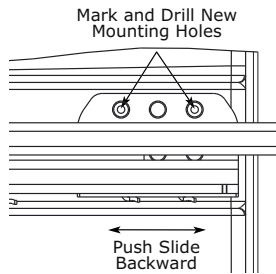

3. Mark new drilling holes using different sets of mounting holes on the slide.

Note: Front location holes are shown. Corresponding rear holes will also need to be marked.

4. Drill all the new holes with a #30 drill bit.
5. Remount the slide.

FRONT-TO-BACK ADJUSTMENT

The drawer will need a Front-to-Back Adjustment if, when viewed from the side, the drawer front is cocked forward or back. This is caused by the front slide mountings not being level with the rear slide mountings.

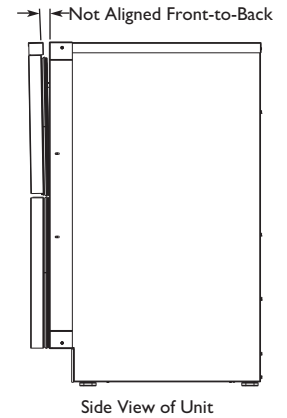

Minor Adjustment:

Note: The mounting holes on the slide are slightly larger than the screws' diameter.

1. Loosen one slide's mounting screws.
2. Level the slide.
3. Retighten the screws.
4. Repeat procedure for the other slide.

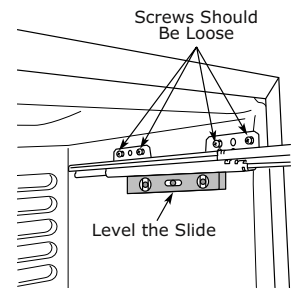

Severe Adjustment:

Note: The slides have extra mounting holes that may be used.

1. Loosen one slide's rear mounting screws.
2. Remove the slide's front mounting screws.
3. Reposition the slide so it is level.
4. Mark new front drilling holes using a different set of mounting holes on the slide.
5. Drill the new holes with a #30 drill bit.
6. Remount the slide.
7. Repeat procedure for the other slide.

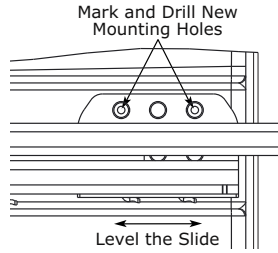

Minor Adjustment:

Note: The mounting holes on the slide are slightly larger than the screws' diameter.

1. Loosen one slide's mounting screws.
2. Push the slide upward or downward to match the position of the other slide.
3. Retighten the screws.
4. Repeat the procedure with the other slide if necessary.

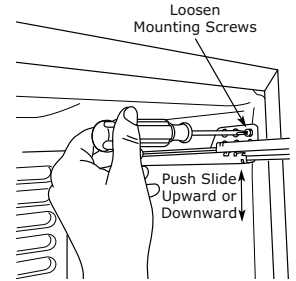

Severe Adjustment:

Note: The slides have extra mounting holes that may be used.

1. Remove one slide's mounting screws.
2. Reposition the slide so it is the same distance from the bottom of the liner as the other slide. Measure to confirm.
3. Mark new drilling holes using different sets of mounting holes on the slide.

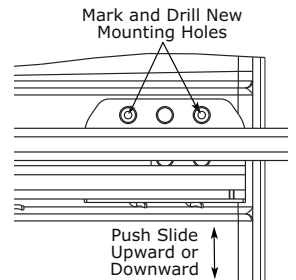

TOP-TO-BOTTOM (AND LEFT-TO-RIGHT) ADJUSTMENT

The drawer will need a Top-to-Bottom Adjustment if, when viewed from the front, the drawer is not level horizontally. Viewed from the top, one side will protrude. This is caused by one of the slides being mounted higher than the other slide on the unit's liner.

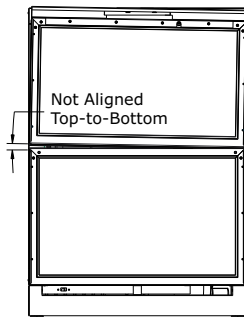

Front View of Unit

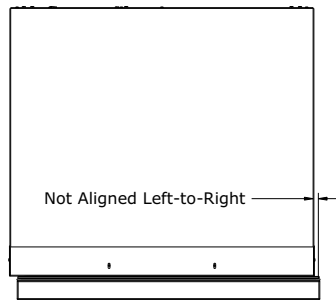

Top View of Unit

Note: Front location holes are shown. Corresponding rear holes will also need to be marked.

4. Drill all the new holes with a #30 drill bit.
5. Remount the slide.

RE-INSTALLATION OF DRAWER



Use care when handling the drawer. Drawer edges, drawer rail and the unit's slide may be sharp.



1. Set the drawer's rails onto the slides.
2. Re-install the rails' mounting screws.

First Use

All U-Line controls are preset at the factory. Initial startup requires no adjustments.

NOTICE







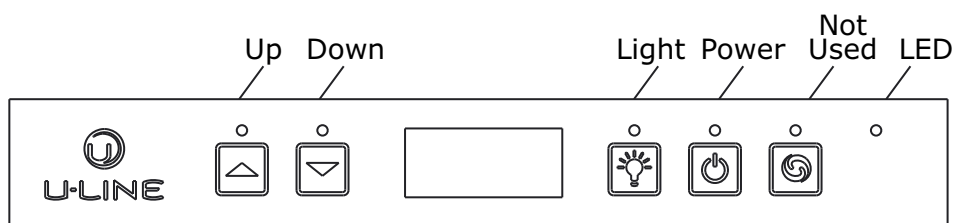



U-Line recommends allowing the unit to run overnight before loading with product.

When plugged in, the unit will begin operating under the factory default settings. If the unit was turned off during installation, simply press  and the unit will immediately switch on. To turn the unit off, press .

Control Operation



CONTROL FUNCTION GUIDE

| FUNCTION | COMMAND | DISPLAY/OPTIONS |
|-------------------------------|--|---|
| ON/OFF | Press  and release | Unit will immediately turn ON or OFF. |
| Toggle lights | Press  and release to leave interior light on for 3 hours | Glass door wine and beverage centers only. |
| Adjust refrigerator set point | Press  or  and release | When the "F" or "C" in the display is flashing, press  or  to adjust the set point temperature. |
| View temperature in unit | Press  and  together and release | The display will flash and then toggle from set point to temperature in unit. |
| Toggle between F/C | Hold  and  for 5 seconds | The display will change units. |

DOOR ALERT NOTIFICATION

When the door is left open for more than 5 minutes:

- An audible tone will sound for several seconds every minute.
- "dr" will appear in display.

Close door to silence alert and reset.

Sabbath Mode

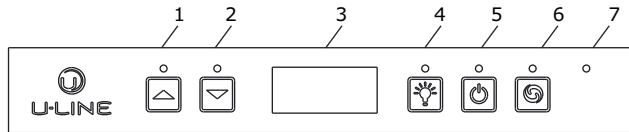

This unit is Star-K certified and offers a Sabbath mode. Sabbath mode disables system responses to user initiated activities and all external functions, including lighting, display and audible alarms. The unit will still maintain internal temperatures and set points. View a full list of Star-K certified U-Line units at www.star-k.org.

To enable Sabbath Mode:

1. Press  (4) and hold for ten seconds and release (the °F/°C symbol will flash briefly at the end of the ten second period).
2. The interior light and control display (3) will go dark until user resets mode.
3. NOTE: Although the display will not be visible, the temperature controls in the unit remain active and preserve the interior temperature.

Sabbath Mode remains active until  (4) is quickly pressed and released.

Airflow and Product Loading

NOTICE

The unit requires proper airflow to perform at its highest efficiency. Do not block the front grille, or the unit will not perform as expected. Do not install the unit behind a door. When loading your unit, leave space between the evaporator and product loaded. Anything in direct contact with the evaporator is subject to freezing.

When properly loaded, your U-Line unit will store up to 142 (12 oz. [330 ml]) cans or 90 (12 oz. [330 ml]) bottles.

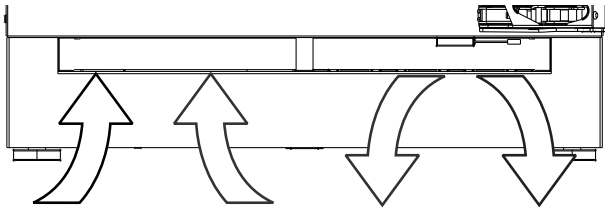

Cleaning

EXTERIOR CLEANING

Stainless Models

Stainless door panels and handles can discolor when exposed to chlorine gas, pool chemicals, saltwater or cleaners with bleach.

Keep your stainless unit looking new by cleaning with a good quality all-in-one stainless steel cleaner and polish monthly. For best results use Claire® Stainless Steel Polish and Cleaner. Comparable products are acceptable. Frequent cleaning will remove surface contamination that could lead to rust. Some installations may require cleaning weekly.

Do not clean with steel wool pads.

Do not use stainless steel cleaners or polishes on any glass surfaces.

Clean any glass surfaces with a non-chlorine glass cleaner.

Do not use cleaners not specifically intended for stainless steel on stainless steel surfaces (this includes glass, tile and counter cleaners).

If any surface discoloring or rusting appears, clean it quickly with Bon-Ami® or Barkeepers Friend Cleanser® and a nonabrasive cloth. Always clean with the grain. Always finish with Claire® Stainless Steel Polish and Cleaner or comparable product to prevent further problems.

Using abrasive pads such as Scotchbrite™ will cause the graining in the stainless steel to become blurred.

Rust not cleaned up promptly can penetrate the surface of the stainless steel and complete removal of the rust may not be possible.

Integrated Models

To clean integrated panels, use household cleaner per the cabinet manufacturer's recommendation.

INTERIOR CLEANING

Disconnect power to the unit.

Clean the interior and all removed components using a mild nonabrasive detergent and warm water solution applied with a soft sponge or non-abrasive cloth.

Rinse the interior using a soft sponge and clean water.

Do not use any solvent-based or abrasive cleaners. These types of cleaners may transfer taste to the interior products and damage or discolor the lining.

DEFROSTING

Under normal conditions this unit does not require manual defrosting. Minor frost on the rear wall or visible through the evaporator plate vents is normal and will melt during each off cycle.

If there is excessive build-up of 1/4" (6 mm) or more, manually defrost the unit.

Ensure the door is closing and sealing properly.

High ambient temperature and excessive humidity can also produce frost.



DO NOT use an ice pick or other sharp instrument to help speed up defrosting. These instruments can puncture the inner lining or damage the cooling unit. DO NOT use any type of heater to defrost. Using a heater to speed up defrosting can cause personal injury and damage to the inner lining.

NOTICE

The drain pan was not designed to capture the water created when manually defrosting. To prevent water from overflowing the drain pan and possibly damaging water sensitive flooring, the unit must be removed from cabinetry.

To defrost:

1. Disconnect power to the unit.
2. Remove all products from the interior.
3. Prop the door in an open position (2 in. [50 mm] minimum).
4. Allow the frost to melt naturally.
5. After the frost melts completely clean the interior and all removed components. (See INTERIOR CLEANING).
6. When the interior is dry, reconnect power and turn unit on.

Cleaning Condenser

INTERVAL - EVERY SIX MONTHS

To maintain operational efficiency, keep the front grille (plinth strip/base fascia) free of dust and lint, and clean the condenser when necessary. Depending on environmental conditions, more or less frequent cleaning may be necessary.



Disconnect electric current to the unit before cleaning the condenser.

NOTICE

DO NOT use any type of cleaner on the condenser unit. Condenser may be cleaned using a vacuum, soft brush or compressed air.

1. Remove the grille (plinth strip/base fascia). (See GRILLE-PLINTH INSTALLATION).
2. Clean the condenser coil using a soft brush or vacuum cleaner.
3. Install the grille (plinth strip/base fascia).

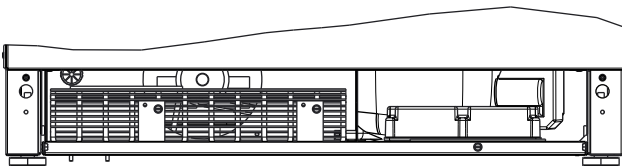

Extended Non-Use

VACATION/HOLIDAY, PROLONGED SHUTDOWN

The following steps are recommended for periods of extended non-use:

1. Remove all consumable content from the unit.
2. Disconnect the power cord from its outlet/socket and leave it disconnected until the unit is returned to service.
3. If ice is on the evaporator, allow ice to thaw naturally.
4. Clean and dry the interior of the unit. Ensure all water has been removed from the unit.
5. The door must remain open to prevent formation of mold and mildew. Open door a minimum of 2" (50 mm) to provide the necessary ventilation.

WINTERIZATION

If the unit will be exposed to temperatures of 40°F (5°C) or less, the steps above must be followed.

For questions regarding winterization, please call U-Line at +1.800.779.2547.



Damage caused by freezing temperatures is not covered by the warranty.

Troubleshooting

BEFORE CALLING FOR SERVICE

If you think your U-Line product is malfunctioning, read the CONTROL OPERATION section to clearly understand the function of the control.

If the problem persists, read the NORMAL OPERATING SOUNDS and TROUBLESHOOTING GUIDE sections below to help you quickly identify common problems and possible causes and remedies. Most often, this will resolve the problem without the need to call for service.

IF SERVICE IS REQUIRED

If you do not understand a troubleshooting remedy, or your product needs service, contact U-Line Corporation directly at +1.800.779.2547.

When you call, you will need your product Model and Serial Numbers. This information appears on the Model and Serial number plate located on the upper right or rear wall of the interior of your product.

NORMAL OPERATING SOUNDS

All models incorporate rigid foam insulated cabinets to provide high thermal efficiency and maximum sound reduction for its internal working components. Despite this technology, your model may make sounds that are unfamiliar.

Normal operating sounds may be more noticeable because of the unit's environment. Hard surfaces such as cabinets, wood, vinyl or tiled floors and paneled walls have a tendency to reflect normal appliance operating noises.

Listed below are common refrigeration components with a brief description of the normal operating sounds they make. NOTE: Your product may not contain all the components listed.

- Compressor: The compressor makes a hum or pulsing sound that may be heard when it operates.

- Evaporator: Refrigerant flowing through an evaporator may sound like boiling liquid.
- Condenser Fan: Air moving through a condenser may be heard.
- Automatic Defrost Drain Pan: Water may be heard dripping or running into the drain pan when the unit is in the defrost cycle.

TROUBLESHOOTING GUIDE



ELECTROCUTION HAZARD. Never attempt to repair or perform maintenance on the unit before disconnecting the main electrical power.

Troubleshooting - What to check when problems occur:

| Problem | Possible Cause and Remedy |
|---|--|
| Digital Display and Light Do Not Work. | Ensure power is connected to the unit. If the unit is cooling, it may be in Sabbath mode. |
| Interior Light Does Not Illuminate. | The light bulb may be defective. If the unit is cooling, it may be in Sabbath mode. |
| Light Remains on When Door Is Closed. | For glass door models, press the light icon and close the door. Check reed switch. |
| Unit Develops Frost on Internal Surfaces. | Frost on the rear wall is normal and will melt during each off cycle. If there is excessive build-up of 1/4" or more, manually defrost the unit. Ensure the door is closing and sealing properly. High ambient temperature and excessive humidity can also produce frost. |
| Unit Develops Condensation on External Surfaces. | The unit is exposed to excessive humidity. Moisture will dissipate as humidity levels decrease. |
| Digital Display Functions, But Unit Does Not Cool. | Ensure the unit is not in "Showroom Mode." Momentarily unplug or interrupt power supply to the unit. |
| Digital Display Shows ER or E Followed by a Number. | E3 indicates the door may be opened too long. Ensure the door is closing properly. For other error codes contact U-Line Customer Service. |

| Problem | Possible Cause and Remedy |
|----------------------------------|---|
| Digital Display Shows 1-16 or 99 | A factory test mode may be enabled. Adjust the temperature to 99 and press the LIGHT icon. |
| Product Is Freezing. | Because product in contact with the rear wall may freeze, ensure no product is touching the rear wall. Adjust the temperature to a warmer set point. |
| Product Is Not Cold Enough. | Air temperature does not indicate product temperature. See CHECKING PRODUCT TEMPERATURE below. Adjust the temperature to a cooler set point. Ensure unit is not located in excessive ambient temperatures or in direct sunlight. Ensure the door is closing and sealing properly. Ensure the interior light has not remained on too long. Ensure nothing is blocking the front grille, found at the bottom of the unit. Ensure the condenser coil is clean and free of any dirt or lint build-up. |

- After 24 hours, check the temperature of the water. If required, adjust the temperature control in a small increment (see CONTROL OPERATION).

Causes which affect the internal temperatures of the cabinet include:

- Temperature setting.
- Ambient temperature where installed.
- Installation in direct sunlight or near a heat source.
- The number of door openings and the time the door is open.
- The time the internal light is illuminated. (This mainly affects product on the top rack or shelf.)

CHECKING PRODUCT TEMPERATURE

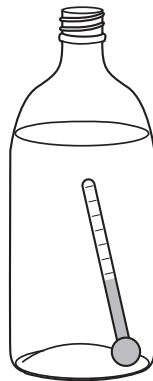

To check the actual product temperature in the unit:

- Partially fill a plastic (nonbreakable) bottle with water.
- Insert an accurate thermometer.
- Tighten the bottle cap securely.
- Place the bottle in the desired area for 24 hours.
- Avoid opening the unit during the testing period.

U-Line Corporation (U-Line) Limited Warranty

One Year Limited Warranty

For one year from the date of original purchase, this U-Line product warranty covers all parts and labor to repair or replace any part of the product that proves to be defective in materials or workmanship. For products installed and used for normal residential use, material cosmetic defects are included in this warranty, with coverage limited to 60 days from the date of original purchase. All service provided by U-Line under the above warranty must be performed by U-Line factory authorized service, unless otherwise specified by U-Line. Service provided during normal business hours.

Available Second Year Limited Warranty

Beyond the standard one year warranty outlined above, U-Line offers an extension of the one year warranty coverage for an additional second year from the date of purchase, free of charge. To take advantage of this second year warranty, you must register your product with U-Line within two months from the date of purchase at u-line.com providing proof of purchase.

Five Year Sealed System Limited Warranty

For five years from the date of original purchase, U-Line will repair or replace the following parts, labor not included, that prove to be defective in materials or workmanship: compressor, condenser, evaporator, drier, and all connecting tubing. All service provided by U-Line under the above warranty must be performed by U-Line factory authorized service, unless otherwise specified by U-Line. Service provided during normal business hours.

Terms

These warranties apply only to products installed in any one of the fifty states of the United States, the District of Columbia, or the ten provinces of Canada. The warranties do not cover any parts or labor to correct any defect caused by negligence, accident or improper use, maintenance, installation, service, repair, acts of God, fire, flood or other natural disasters. The product must be installed, operated, and maintained in accordance with the U-Line User Guide.

The remedies described above for each warranty are the only ones that U-Line will provide, either under these warranties or under any warranty arising by operation of law. U-Line will not be responsible for any consequential or incidental damages arising from the breach of these warranties or any other warranty, whether express, implied, or statutory. Some states do not allow the exclusion or limitation of incidental or consequential damages, so the above limitation or exclusion may not apply to you. These warranties give you specific legal rights, and you may also have other rights which vary from state to state.

Any warranty that may be implied in connection with your purchase or use of the product, including any warranty of *merchantability* or any warranty *fit for a particular purpose* is limited to the duration of these warranties, and only extends to five years in duration for the parts described in the section related to the five year limited warranty above. Some states do not allow limitations on how long an implied warranty lasts, so the above limitations may not apply to you.

- The warranties only apply to the original purchaser and are non-transferable.
- The second year and five year warranties cover products installed and used for normal residential or designated marine use only.
- The warranties apply to units operated outside only if designed for outdoor use by model and serial number.
- Replacement water filters, light bulbs, and other consumable parts are not covered by these warranties.
- The start of U-Line's obligation is limited to four years after the shipment date from U-Line.
- In-home instruction on how to use your product is not covered by these warranties.
- Food, beverage, and medicine loss are not covered by these warranties.
- If the product is located in an area where U-Line factory authorized service is not available, you may be responsible for a trip charge or you may be required to bring the product to a U-Line factory authorized service location at your own cost and expense.
- Units purchased after use as floor displays, and/or certified reconditioned units, are covered by the limited one year warranty only and no coverage is provided for cosmetic defects.
- Signal issues related to Wi-Fi connectivity are not covered by these warranties.

For parts and service assistance, or to find U-Line factory authorized service near you, contact U-Line:
8900 N. 55th Street, Milwaukee, WI 53223 • u-line.com • onlineservice@u-line.com • +1.800.779.2547

Wire Diagram

42348_B WIRING DIAGRAM

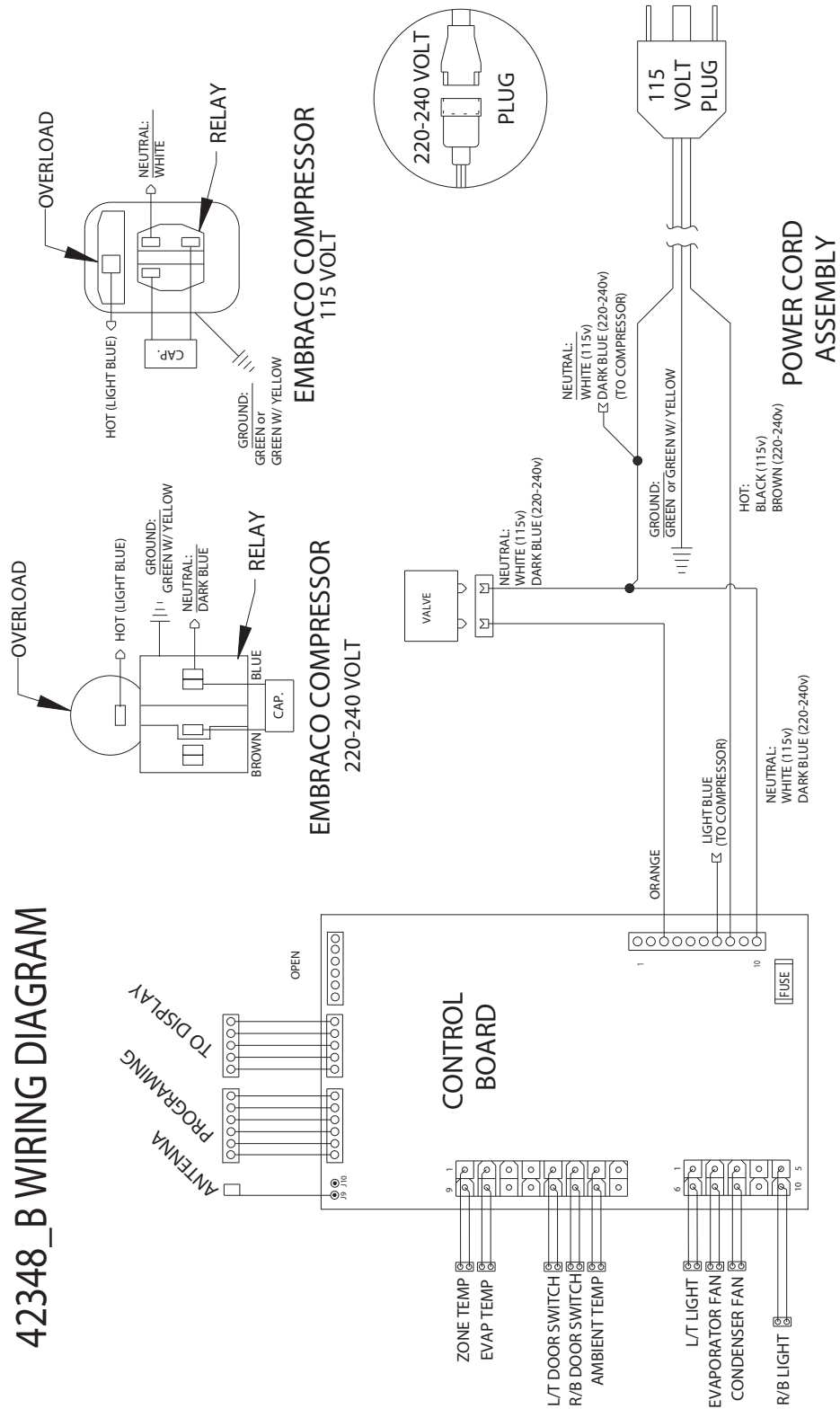

Product Liability

Field service technicians are authorized to make an initial assessment in the event of reported damages. If there are any questions about the process involved, the technician should call U-Line for further explanation.

While inspecting for defects or installation issues, photos should be taken to document any damages or issues found.

During the assessment, if the service technician is able to find the source of the damage and it can be resolved by replacement of a part, the servicer is authorized to replace the part in question. The part that caused the damage must be returned to U-Line in its entirety. The part must be clearly labeled with the serial number of the unit it was removed from, the date, and the servicer who removed the part.

If the service technician determines the damage is the result of installation issues (water connection/drain, etc.), the consumer would be notified and the issues shall be resolved at the direction of the consumer.

If damage is evident and the service technician is unable to find the source, U-Line must be contacted at 1-800-799-2547 for further direction

8900 N. 55th Street • Milwaukee, WI 53223
T: +1.414.354.0300 • F: +1.414.354.354.5696
Website: www.u-line.com

**Right product. Right place.
Right temperature Since 1962.**

Warranty Claims

The following information defines the parameters for filing a warranty claim:

- Valid serial number needed
- Valid model number needed
- Narda (or equivalent) form or submitted online at www.u-line.com
- 60 day submittal deadline from date of completed service
- Only one repair or unit per warranty claim
- Refrigerant should be labeled and included on the labor submittal
- Door and water level adjustments are covered 30 days from install date.

Serial Number Requirements:

14 30911 12 XXXX
Year Month

A typical serial number is shown above. The first two digits of the first segment, 14, represents the production year. The number between the dashes, 12, represents the production month. In most cases, warranty status can be verified by the production date information within the serial number.

- Alternatively, a Proof of Purchase (or equivalent) may be submitted with the warranty claim to document

warranty status. We also accept the following information to verify warranty status:

- New Construction Occupancy Documents
- Closing Paperwork
- Final Billing – Remodel

Noting all of the following on the warranty claim will be considered proof of purchase, hard copy will not be required:

- Name of the selling Dealer
- Date of purchase/installation
- Order or Invoice number (if available)
- Description of document reviewed (i.e. store receipt, closing paperwork, etc)

Parts and labor claims are paid separately. Indicate part numbers and description for parts used in the warranty repair. Include the purchase invoice and name of the parts supplier used to procure the parts.

Parts

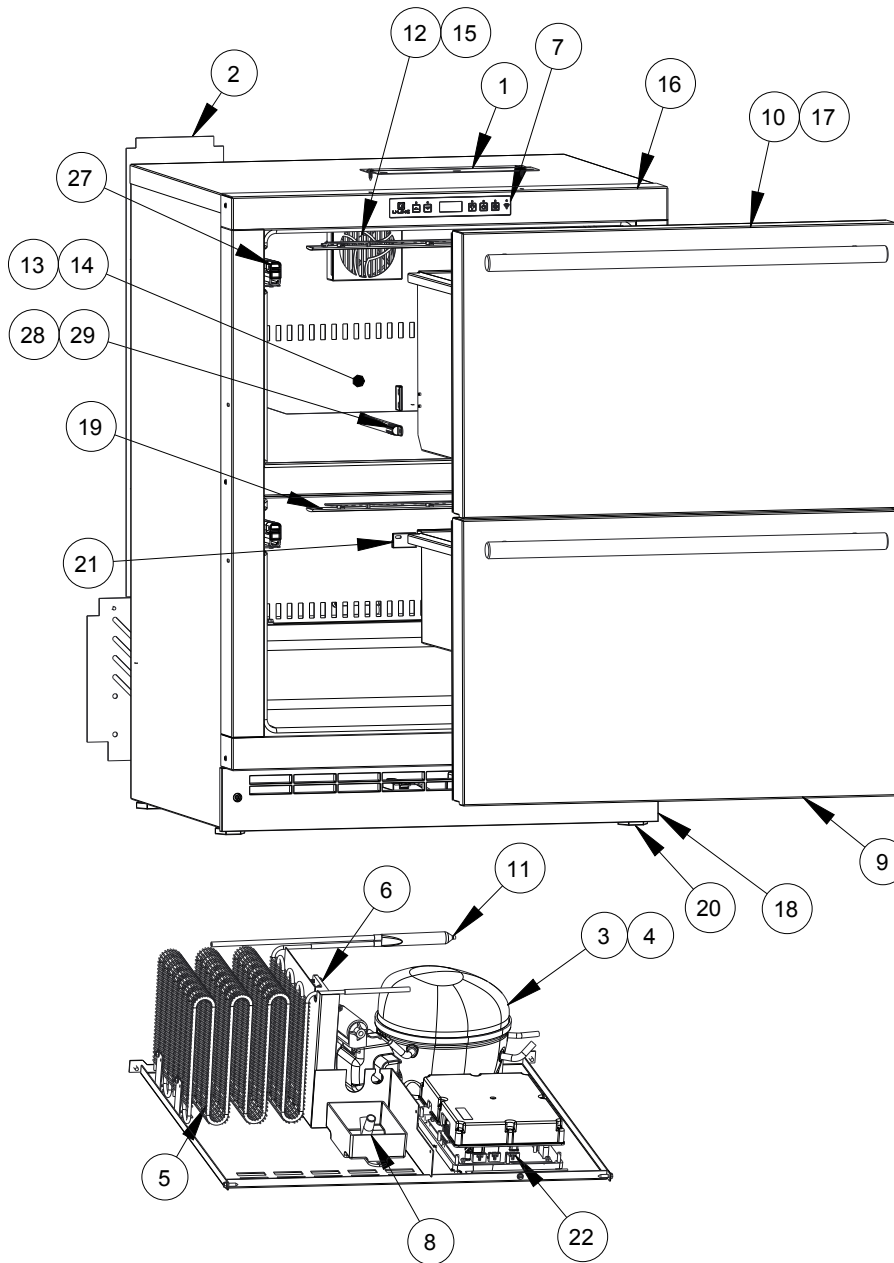

| U-2224DWRS-00A | | |
|----------------|--------------------------------|-------------|
| Item | Description | U-Line P/N |
| 1 | Anti tip bracket w/screws | 80-54012-00 |
| 2 | Back panel | 80-54086-00 |
| 3 | Compressor electricals only | 80-54149-00 |
| 4 | Compressor w/electricals | 80-54150-00 |
| 5 | Condenser assembly | 80-54043-00 |
| 6 | Condenser fan w/screws | 80-54014-00 |
| 7 | Display module | 80-54007-00 |
| 8 | Drain pan w/double sided tape | 80-54217-00 |
| 9 | Drawer assy, lower | 80-54181-00 |
| 10 | Drawer assy, upper | 80-54182-00 |
| 11 | Drier | 80-54055-00 |
| 12 | Evap fan w/cover and screws | 80-54151-00 |
| 13 | Evaporator assembly | 80-54057-00 |
| 14 | Evaporator cover w/screws | 80-54866-00 |
| 15 | Evaporator fan | 80-54321-00 |
| 16 | Frame assembly | 80-54833-00 |
| 17 | Gasket, drawer | 80-54183-00 |
| 18 | Grille w/screws | 80-54052-00 |
| 19 | LED light strip and cover assy | 80-54000-00 |
| 20 | Leg Levelers (4) | 80-54019-00 |
| 21 | Magnet | 80-54100-00 |
| 22 | Main board (no case or wires) | 80-54008-00 |
| 23 | Packaging | 80-54160-00 |
| 24 | Wire harness, power cord | 80-54836-00 |
| 25 | Reed switch | 80-54134-00 |
| 26 | Slide and divide | 80-54115-00 |
| 27 | Slide assembly | 80-54119-00 |
| 28 | Thermistor (1 pc) | 80-54006-00 |
| 29 | Thermistor cover and pin | 80-54023-00 |
| 30 | Tool, leg leveler | 80-54794-00 |
| 31 | WIFI antenna | 80-54804-00 |
| 32 | Wire Harness, board | 80-54831-00 |

Ordering Replacement Parts

If you have a purchasing account, please utilize our service website to order parts.

Orders may also be placed by Fax or phone. See our contact information below:

www.U-LineService.com (with service login)

FAX Number: +1.414.354.5696

Phone Number: +1.800.779.2547

NOTICE

Use only genuine U-Line replacement parts. The use of non-U-Line parts can reduce speed of ice production, cause water to overflow from ice maker mold, damage the unit, and void the warranty.

Warranty parts will be shipped at no charge after U-Line confirms warranty status. Please provide the model, serial number, part number and part description. Some parts will require color or voltage information.

If U-Line requires the return of original parts, we will inform you when the parts order is taken. This requirement will be noted on your packing list. A prepaid shipping label will be included with the replacement part. Please enclose a copy of the parts packing list and any labor claims with your return. Please be sure the model and serial numbers are legible on the paperwork. Tag the part with the reported defect.

When ordering a non-warranty part, you will need an open account and tax exemption on file at U-Line. Another option would be to visit www.u-line.com to locate an authorized parts distributor in your area.

System Diagnosis Guide

REFRIGERATION SYSTEM DIAGNOSIS GUIDE

| System Condition | Suction Pressure | Suction Line | Compressor Discharge | Condenser | Capillary Tube | Evaporator | Wattage |
|-----------------------------|-----------------------------------|---------------------------------|-------------------------|---|-----------------------------------|--|--------------------|
| Normal | Normal | Slightly below room temperature | Very hot | Very hot | Warm | Cold | Normal |
| Overcharge | Higher than normal | Very cold may frost heavily | Slightly warm to hot | Hot to warm | Cool | Cold | Higher than normal |
| Undercharge | Lower than normal | Warm-near room temperature | Hot | Warm | Warm | Extremely cold near inlet - Outlet below room temperature | Lower than normal |
| Partial Restriction | Somewhat lower than normal vacuum | Warm - near room temperature | Very hot | Top passes warm - Lower passes cool (near room temperature) due to liquid | Room temperature (cool) or colder | Extremely cold near inlet - Outlet below room temperature backing up | Lower than normal |
| Complete Restriction | In deep vacuum | Room temperature (cool) | Room temperature (cool) | Room temperature (cool) | Room temperature (cool) | No refrigeration | Lower than normal |
| No Gas | 0 PSIG to 25" | Room temperature (cool) | Cool to hot | Room temperature (cool) | Room temperature (cool) | No refrigeration | Lower than normal |

Compressor Specifications

⚠ DANGER

Electrocution can cause death or serious injury. Burns from hot or cold surfaces can cause serious injury. Take precautions when servicing this unit.

Disconnect the power source.

Do not stand in standing water when working around electrical appliances.

Make sure the surfaces you touch are not hot or frozen.

Do not touch a bare circuit board unless you are wearing an anti-static wrist strap that is grounded to an electrical ground or grounded water pipe.

Handle circuit boards carefully and avoid touching components.

To measure the start winding resistance, measure across the C and S pins.

To measure the run winding resistance, measure across the C and R pins.

Also check S to R and you should get the sum of the run and start windings.

To ensure the windings are not shorted, check the S and R to ground.

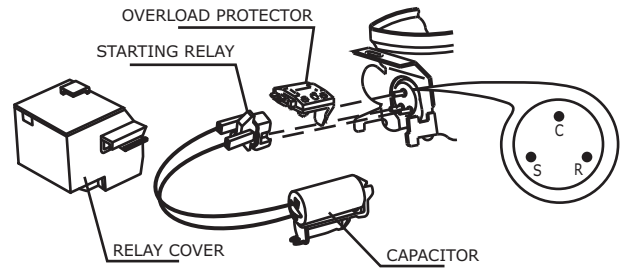

ULIN_0368_A

| | EMX20CLC |
|-----------------|------------------|
| Refrigerant | R600a |
| Voltage | 115 - 127 VAC |
| Frequency | 60 Hz |
| Run Cap | 12µF/165 VAC |
| Start Winding | 6.7 Ohm at 77°F |
| Run Winding | 12.6 Ohm at 77°F |
| LRA | 3.7 A |
| FLA | 0.5 A |
| Starting Device | 8EA14C |
| Overload | 4TM142RFBYY-53 |

* All resistance readings are ±10%

Troubleshooting - Extended



Never attempt to repair or perform maintenance on the unit until the main electrical power has been disconnected from the unit.

SPECIFIC ERRORS AND ISSUES

The technically advanced diagnostic capabilities of the electronic controls utilized on the 1200 and 2200 series units allows for easy and thorough troubleshooting.

Navigation of the control is the key and is explained in the CONTROL OPERATION section of the manual, along with control button layout, control function descriptions, a service mode menu and service menu selection explanations.

Verification of temperature and thermistor performance can be identified by directly viewing thermistor readings in the service mode.

Component failure issues can be identified through service mode menu #19, "Component Testing." Individual components can be switched on and off to check for both proper function of a specific component and also delivery of supply voltage to the components through the relays and DC outputs located on the relay/power board.

Included in this section are some diagnostic tips and of course, if additional help is required please contact the U-Line Corp, "Customer Care Facility" at +1.800.779.2547 for assistance.

NORMAL OPERATING SOUNDS

All models incorporate rigid foam insulated cabinets to provide high thermal efficiency and maximum sound reduction for its internal working components. Despite this technology, your model may make sounds that are unfamiliar.



Normal operating sounds may be more noticeable because of the unit's environment. Hard surfaces such as cabinets, wood, vinyl or tiled floors and paneled walls have a tendency to reflect normal appliance operating noises.

Listed below are common refrigeration components with a brief description of the normal operating sounds they make. NOTE: Your product may not contain all the components listed.

- Compressor: The compressor makes a hum or pulsing sound that may be heard when it operates.
- Evaporator: Refrigerant flowing through an evaporator may sound like boiling liquid.
- Condenser Fan: Air moving through a condenser may be heard.
- Automatic Defrost Drain Pan: Water may be heard dripping or running into the drain pan when the unit is in the defrost cycle.

Solenoid Valves: An occasional clicking sound may be heard as solenoid valves are operated.

TROUBLESHOOTING GUIDE

| Concern | Potential Causes | Suggested Remedy |
|-----------------------------------|---|--|
| Not Cooling | Compressor overheating | Verify proper air flow through condenser. Is condenser clean? |
| | | Confirm condenser fan operation. |
| | | Confirm proper compressor operating voltage. Use #19, Component Testing in Service Mode. |
| | Compressor not operating | Confirm proper compressor operating voltage. Use #19, Component Testing in Service Mode. |
| | | Test overload and relay, replace as needed. |
| Compressor operating - no cooling | Refer to System Diagnosis Guide. | |
| Evaporator fan not operating | Use #19, Component Testing in Service Mode. | |
| Frozen Product | Control set too cold | Adjust Set Point Temp accordingly. |
| | Review logged error codes | Refer to #14, Error Log in Service Mode. |
| | Thermistor failure | Check Error Log in Service Mode, OHM thermistor. |
| Frost Buildup Inside Unit | Door Ajar or Restricted from Closing | Check door clearance to adjoining cabinetry. Check distribution of product in unit. |
| | Evaporator fan not operating | Use Relay Toggle, Component Testing in Service Mode. |
| | Thermistor failure | Check Error Log. |
| Display Not Working | Unit placed in Sabbath mode? | Press and hold  for 5 seconds to check. |
| | Display unplugged | Verify that both ends of the display wiring are firmly connected. |
| | Display wiring broken or damaged | Perform continuity test of wiring and replace as needed. |
| Internal Lights Not Working | Control Setting | Unit set to Sabbath Mode. Press and hold  for 5 seconds to check. |
| | Door switch misaligned or defective | Check the function of reed switch and door magnet adjustment. |
| Noisy | Refrigeration tubing touching cabinet | Carefully reposition tubing. |
| | Fan blade obstruction (wiring, foam insulation, packaging material) | Remove obstruction. |

MAIN CONTROL

The main control board is very robust and is rarely the cause of system issues. It is important to fully diagnose the board for any suspected failures before attempting to remove the board for replacement or service. Follow the guidelines below to fully test and diagnose the main control.

Power Fault

If the unit does not (or seems to not) power on, follow the flow chart below to help diagnose the issue. Before beginning it is important to first verify the unit is not simply set to sabbath mode.

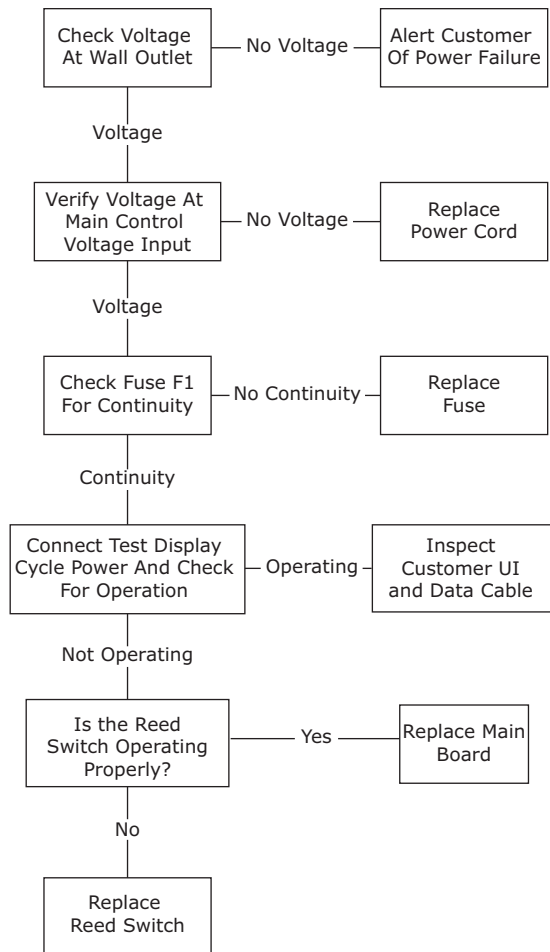

Testing The Main Control

If the main control is suspected of being faulty, the following procedure should be performed to verify main control for functionality.

Relay & DC Outputs

One of the primary functions of the main control is to operate the multiple relay and DC outputs during each cycle. Verify proper operation of these relays using the following procedure.

1. Enter "Relay Toggle" through the service menu.

NOTICE

Frequently toggling the compressor relay could force the compressor into overload. The compressor will automatically deactivate during an overload and will remain deactivated until the overload switch cools. This could take some time. It is important to allow the compressor at least 5 minutes off time between relay cycles.

2. Toggle the relay. Its related component should activate / deactivate with the switching of the relay. If it does not, test component.

Other Suspected Main Control Faults

If other components have been ruled out as being faulty but the unit continues to have operating issues, it is most likely due to a configuration error. Configuration errors can be cleared by restoring the unit to its factory default setting. Factory defaults may be restored through the service menu.



Precautions must be taken while working with live electrical equipment. Be sure to follow proper safety procedures while performing tests on live systems.

REED SWITCH

A reed switch is used to monitor door state. When the door is closed magnetic force pulls the reed to its contact and closes the circuit which turns the light and display off. When the door is open the reed pulls away from the contact and opens the circuit. If the door is left open for longer than 5 minutes, the switch will trigger an error code and set an audible warning.

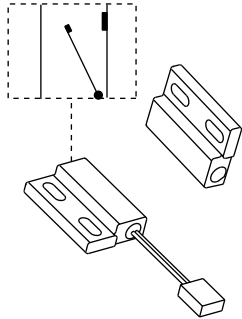

Magnet Away From Switch
(Door Open)
(Switch Open)

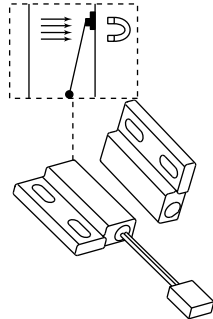

Magnet Close To Switch
(Door Closed)
(Switch Closed)

Control Operation - Service

UI BUTTON LAYOUT

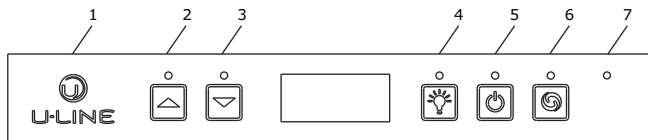

1. Hidden Button

- Accesses Service Menu
- No LED directly above. All LEDs turn on with button activation except #7.

2. Up Button

- Increases temperature
- Navigates through service menu
- LED activated with button activation.

3. Down Button

- Decreases temperature
- Navigates through service menu
- LED activated with button activation

4. Light Button

- Activates light for 3 hours on select models
- Used to select items in service menu
- LED activated with button activation

5. Power Button

- Turns unit off/on
- LED activated with button activation (only turning unit off)











6. Clean Button

- Activates Clean Cycle on CLR models
- LED activated with button activation

7. LED

- No button

CONTROL FUNCTION QUICK GUIDE

| FUNCTION | COMMAND | DISPLAY/OPTIONS |
|---------------------------------|---|--|
| ON/OFF | Press  and release | Unit will immediately turn ON or OFF |
| Toggle lights | Press  and release to leave interior light on for 3 hours | Glass door wine captains and beverage centers only. |
| Adjust refrigerator temperature | Push  or  and release | When the "F" or "C" in the display is flashing, push  or  to adjust the set point temperature. |
| View temperature in unit | Push  and  and release the together | The display will flash and then toggle from set point to temperature in unit. |
| Toggle between F/C | Hold the  and  for five seconds | The display will change units. |

DOOR ALERT NOTIFICATION

When the door is left open for more than 5 minutes:

- An audible tone will sound for several seconds every minute.
- "dr" will appear in display.

Close door to silence alert and reset.

VIEWING ACTUAL TEMPERATURE

In viewing temperature in these modes any offsets are taken into account. This means that if you place a thermistor in a known temperature, let's say ice water, it may not read the 32°F that you would assume. If the control offset was preset at -3°F while you placed the thermistor in an icebath, the actual thermistor reading when viewing actual temperature would read 35°F. In the unit this would cause the cabinet to push itself 3° cooler. To view pure thermistor readings you must go into the service menu and choose the correct option.

To view the thermistor temperature, push and release the up and down keys. The display will show the corrected refrigerator temperature.

SHOWROOM MODE

This mode is designed to show units in a display environment. When in this mode the only functions will be the control and cabinet lights. The compressor, fans, etc. will not operate. To enter/exit this mode hold the light key and the power key for 5 seconds. The display will flash once and beep and the degree symbol will begin to flash.

When the degree symbol is flashing the unit will allow the use of the control for demonstrations. The unit can be left in this mode indefinitely.

SERVICE MODE

This mode has options available for service diagnostics. To enter the mode hold the hidden key for 10 seconds. The display will show "0." When in this mode use the up and down arrows to select the desired option. The LIGHT key is the ENTER key and will initiate the function. If changing a setting, you must press the LIGHT key again to retain the changed setting. To exit the service mode scroll to option "0" and press the LIGHT key. After five minutes of not touching any keys the mode will also exit automatically.

SERVICE MODE GUIDE

| # | Service Mode Menu Item |
|----|---|
| 1 | View thermistor #1 (no offsets) |
| 2 | View thermistor #2 (no offsets) |
| 3 | View thermistor #3 (no offsets) |
| 4 | View thermistor #4 (no offsets) |
| 5 | Adjust thermistor #1 offset |
| 6 | Adjust thermistor #2 offset |
| 7 | Adjust thermistor #3 offset |
| 8 | Adjust thermistor #4 offset |
| 9 | View thermistor #2 set point no offsets |
| 10 | View thermistor #3 set point no offsets |
| 11 | View thermistor #4 set point no offsets |
| 12 | Adjust defrost interval 3 to 24 hours |
| 13 | Adjust defrost duration 0 to 99 minutes |
| 14 | View error log |
| 15 | Clear error log |
| 16 | Adjust thermistor #1 differential |
| 17 | Adjust evaporator fan delay in minutes (start of cooling cycle) 0 - 99 minutes |
| 18 | Adjust evaporator fan delay in minutes (after cooling cycle stops) 0 - 99 minutes |
| 19 | Individual component toggle |
| 20 | Model number indicator |
| 21 | Light all LED segments of display |
| 22 | View defrost cycles |
| 23 | View compressor run time |
| 24 | Activate defrost/harvest |
| 25 | Restore factory defaults |
| 26 | View software version - main board |
| 27 | View software version - user interface |
| 28 | Login period |
| 29 | Factory test mode |
| 0 | Exit service mode |

NAVIGATE SERVICE MODE

Use up or down arrows to scroll through the menu.

Use the light bulb key to enter or exit menu. If values have been changed, they will be saved when exiting.

SERVICE MODE GUIDE

1. **THERMISTOR 1 — ZONE**
This shows the pure thermistor reading with no offsets taken into account.
2. **THERMISTOR 2 — EVAPORATOR**
This shows the pure thermistor reading with no offsets taken into account.
3. Does not apply to this model.
4. Does not apply to this model.
5. **THERMISTOR 1 — ZONE OFFSET**
(DO NOT MAKE AN ADJUSTMENT TO THIS WITHOUT CONTACTING TECH LINE: 800-779-2547)

This calibration is only to be used if actual temperature at thermistor #1 is off from set point.

By adjusting the offset higher we can force the unit to drive the temperature down below the set point. (example: adjusting from 0 to +2 will drop the unit temperature 2 degrees)
6. **THERMISTOR 2 — EVAPORATOR OFFSET**
(DO NOT MAKE AN ADJUSTMENT TO THIS WITHOUT CONTACTING TECH LINE: 800-779-2547)
7. **THERMISTOR 3 — AMBIENT OFFSET**
Not adjustable.
8. Does not apply to this model.
9. **THERMISTOR 2 — SET POINT MINUS OFFSET**
This shows the thermistor reading with offsets taken into account.
10. Does not apply to this model.
11. Does not apply to this model.
12. **ADJUST DEFROST INTERVAL — 3 TO 24 HOURS**
This will adjust the interval between defrosts from 3 to 24 hours. Adjusting from the factory settings may cause undesired temperature in the refrigerator section.
13. **ADJUST DEFROST DURATION — 0 TO 99 MINUTES**
The length of the defrost can be adjusted 0 to 99 minutes long. The other defrost parameters still apply. Lengthening a defrost may cause higher than normal temperatures in the refrigerator section.

14. VIEW ERROR LOG

A list of the errors in the order they occurred will scroll once on the display. All errors are logged in memory. Only door error is displayed on the display and has an audible signal.

E0: Door 1 (upper) open.

E1: Thermistor 1 open.

E2: Thermistor 2 open.

E3: Thermistor 3 open.

E4: Thermistor 4 open (Does not apply to this model).

E5: Thermistor 1 shorted.

E6: Thermistor 2 shorted.

E7: Thermistor 3 shorted.

E8: Thermistor 4 shorted (Does not apply to this model).

E9: Door 2 (lower) open.

P1: Pump Circuit open (Does not apply to this model).

15. CLEAR ERROR LOG

To clear errors, press and hold  (5 seconds) when CLR is flashing.

16. THERMISTOR — 1 DIFFERENTIAL

This number should not be adjusted.

17. EVAPORATOR FAN DELAY IN MINUTES — ON

“Fan Delay On” is the amount of time in minutes the fan will be delayed from starting from the beginning of a cooling cycle. Adjustable 0-99 minutes.

18. EVAPORATOR FAN DELAY IN MINUTES — OFF

“Fan Delay Off” is the amount of time in minutes the fan will continue to run at the end of a cooling cycle. Adjustable 0-99 minutes.

19. INDIVIDUAL COMPONENT TOGGLE

| Display # | Relay/Output |
|-----------|--------------|
| 0 | Exit |
| 2 | Relay 2 |
| 3 | Relay 3 |
| 4 | Relay 4 |
| 5 | Relay 5 |
| 6 | Relay 6 |
| 7 | Relay 7 |
| 8 | DC Output 1 |
| 9 | DC Output 2 |
| 10 | DC Output 3 |
| 11 | DC Output 4 |
| 12 | DC Output 5 |

SEE RELAY/OUTPUT CHART

20. MODEL NUMBER INDICATOR

Displays the two-digit model number of the specific unit. See model list table.

21. LIGHT ALL LED SEGMENTS

This will illuminate all the LEDs on the display to ensure they work properly.

22. VIEW DEFROST CYCLES

Displays the number of defrosts that have occurred in the past 24 hours.

23. VIEW COMPRESSOR RUNTIME

This will show the number of minutes the compressor has run in the prior cycle (or current cycle if the compressor was running when service mode was entered).

24. ACTIVATE DEFROST/HARVEST

Turns on the hot gas bypass valve allowing hot gas to circulate through the evaporator causing frost to melt.

25. RESTORE FACTORY DEFAULTS

Will restore all adjustable functions to their factory settings.

26. SOFTWARE VERSION — MAIN BOARD

Displays software version of the main control board.

27. SOFTWARE VERSION — USER INTERFACE

Displays software version of the user interface.

28. LOG IN PERIOD

Factory use only - do not adjust.

29. FACTORY TEST MODE



Should be 0.

0. EXIT SERVICE MODE

MODEL LIST

| 1000 | MODEL INDICATOR | 2000 (120V) | MODEL INDICATOR | 2000 (230V) | MODEL INDICATOR |
|----------|-----------------|-------------|-----------------|-------------|-----------------|
| 1215R | 07 | 2218R | 05 | 2245R | 55 |
| 1215WC | 12 | 2218RGL | 04 | 2245DC | 54 |
| 1224BEV | 13 | 2218WC | 06 | 2245WC | 56 |
| 1224DWR | 08 | 2224BEV | 00 | 2260DC | 50 |
| 1224R | 14 | 2224R | 02 | 2260R | 52 |
| 1224RF | 09 | 2224RGL | 01 | 2260RDC | 51 |
| 1224RSOD | 10 | 2224WC | 03 | 2260WC | 53 |
| 1224WC | 15 | 2224ZWC | 59 | 2260ZWC | 58 |
| CLR1215 | 18 | ADA24R | 17 | 2260DWR | 70 |
| CO1224F | 19 | | | | |
| 1224FZR | 11 | | | | |

PROGRAMMING THE UNIT TO CORRECT MODEL NUMBER

1. Disconnect the unit from power source.
2. Push and hold the U-Line button. 
3. While still holding the U-Line button, plug the unit into the appropriate power source.
4. When the flashing digits appear (3-5 seconds), use the up and down arrow buttons to select the appropriate model number*.  or 

*(See Above "Model List")

5. Press the light bulb button once. 
6. The display will blink, and then will appear as the programmed display.

Relay / Output Chart

| Name | Relay 2 | Relay 3 | Relay 4 | Relay 5 | Relay 6 | Relay 7 | DC Output 1 | DC Output 2 | DC Output 3 | DC Output 4 | DC Output 5 |
|----------|----------------|----------------|-------------|---------------|---------------|------------|-------------|----------------|---------------|-------------|--------------|
| 1215R | N/A | N/A | N/A | N/A | N/A | Compressor | Light | Evaporator Fan | Condenser Fan | N/A | N/A |
| 1215WC | N/A | N/A | N/A | N/A | N/A | Compressor | Light | Evaporator Fan | Condenser Fan | N/A | N/A |
| 124BEV | N/A | N/A | N/A | N/A | N/A | Compressor | Light | Evaporator Fan | Condenser Fan | N/A | N/A |
| 1224DWR | Mullion Heater | N/A | N/A | N/A | N/A | Compressor | Top Light | Evaporator Fan | Condenser Fan | N/A | Bottom Light |
| 1224R | N/A | N/A | N/A | N/A | N/A | Compressor | Light | Evaporator Fan | Condenser Fan | N/A | N/A |
| 1224RF | N/A | N/A | Pan Heater | Hot Gas Valve | N/A | Compressor | Light | Evaporator Fan | Condenser Fan | N/A | N/A |
| 1224RSOD | N/A | N/A | N/A | N/A | N/A | Compressor | Light | Evaporator Fan | Condenser Fan | N/A | N/A |
| 1224WC | N/A | N/A | N/A | N/A | N/A | Compressor | Light | Evaporator Fan | Condenser Fan | N/A | N/A |
| ADA24R | N/A | N/A | N/A | N/A | N/A | Compressor | Light | Evaporator Fan | Condenser Fan | N/A | N/A |
| CLR1215 | N/A | Pump | Water Valve | Hot Gas Valve | Condenser Fan | Compressor | Light | N/A | N/A | N/A | N/A |
| CO1224F | Ice Maker 2 | Ice Maker 1 | Pan Heater | Hot Gas Valve | N/A | Compressor | Light | Evaporator Fan | Condenser Fan | N/A | N/A |
| 2218R | N/A | N/A | N/A | N/A | N/A | Compressor | Light | Evaporator Fan | Condenser Fan | N/A | N/A |
| 2218RGL | N/A | N/A | N/A | N/A | N/A | Compressor | Light | Evaporator Fan | Condenser Fan | N/A | N/A |
| 2218WC | N/A | N/A | N/A | N/A | N/A | Compressor | Light | Evaporator Fan | Condenser Fan | N/A | N/A |
| 2224BEV | N/A | N/A | N/A | N/A | N/A | Compressor | Light | Evaporator Fan | Condenser Fan | N/A | N/A |
| 2224R | N/A | N/A | N/A | N/A | N/A | Compressor | Light | Evaporator Fan | Condenser Fan | N/A | N/A |
| 2224RGL | N/A | N/A | N/A | N/A | N/A | Compressor | Light | Evaporator Fan | Condenser Fan | N/A | N/A |
| 2224WC | N/A | N/A | N/A | N/A | N/A | Compressor | Light | Evaporator Fan | Condenser Fan | N/A | N/A |
| 2224ZWC | N/A | N/A | v12 | v1 | N/A | Compressor | Top Light | N/A | Condenser Fan | N/A | Bottom Light |
| 2245R | N/A | Hot Gas Valve | N/A | N/A | N/A | Compressor | Light | Evaporator Fan | Condenser Fan | N/A | N/A |
| 2245RDC | N/A | Hot Gas Valve | N/A | N/A | N/A | Compressor | Light | Evaporator Fan | Condenser Fan | N/A | N/A |
| 2245WC | N/A | Hot Gas Valve | N/A | N/A | N/A | Compressor | Light | Evaporator Fan | Condenser Fan | N/A | N/A |
| 2260DC | N/A | N/A | N/A | N/A | N/A | Compressor | Light | Evaporator Fan | Condenser Fan | N/A | N/A |
| 2260R | N/A | N/A | N/A | N/A | N/A | Compressor | Light | Evaporator Fan | Condenser Fan | N/A | N/A |
| 2260RDC | N/A | N/A | N/A | N/A | N/A | Compressor | Light | Evaporator Fan | Condenser Fan | N/A | N/A |
| 2260WC | N/A | N/A | N/A | N/A | N/A | Compressor | Light | Evaporator Fan | Condenser Fan | N/A | N/A |
| 2260ZWC | N/A | N/A | v12 | v1 | N/A | Compressor | Top Light | N/A | Condenser Fan | N/A | Bottom Light |
| 1224FZR | N/A | Defrost Heater | N/A | N/A | Condenser Fan | Compressor | Light | Evaporator Fan | N/A | N/A | N/A |
| 2260DWR | Mullion Heater | N/A | N/A | N/A | N/A | Compressor | Top Light | Evaporator Fan | Condenser Fan | N/A | Bottom Light |
| 2224DWR | Mullion Heater | N/A | N/A | N/A | N/A | Compressor | Top Light | Evaporator Fan | Condenser Fan | N/A | Bottom Light |

Thermistors

Thermistors are used for various temperature readings. Thermistors provide reliable temperature readings using a resistance which varies based on surrounding temperatures. If a faulty thermistor is suspected it may be tested using an accurate ohmmeter.

All thermistors in the unit are identical. If a thermistor is suspected of being defective the resistance can be verified. Place the thermistor in an ice water bath, the resistance should read 16.1k OHMs +/-5% on your meter.

Thermistor connections must be kept clean. A thermistor connection that has become corroded can cause resistance values from the thermistor to change as they pass through a dirty connection to the board.

It is for that reason that we apply dielectric grease to all of our thermistor connections. Dielectric grease will help to keep thermistor connections clean and dry.

If you change a thermistor in the unit please re-apply dielectric grease to the connection. If you encounter a dirty thermistor connection, you should replace the thermistor and the thermistor harness.

Thermistor error information can be found in the Control Operations - Service section.

This unit has **three** thermistors.

Thermistor one (Zone):

Located along the right hand side wall. It is used to maintain the operating temperature within that zone.

Thermistor two (Evaporator):

Located on the evaporator. It is used for defrost.

Thermistor three (Ambient):

Located in the base of the unit (secured to the condenser). It is used to monitor the ambient temperature within the base compartment. It is used for diagnostics.

THERMISTOR FAILURE

Zone Thermistors

If a zone thermistor(s) in the unit fails the unit will continue to cool in a backup mode (Self Preservation Mode) to preserve the integrity of the contents. The unit will otherwise operate normally.

2000 Series Self Preservation Mode:

The unit will cycle on for 10 minutes then off for 40 minutes.

3000 Series Self Preservation Mode:

Cycle times determined by zone - see chart. The error will be displayed on the main display, "Self Test" and logged in "All Errors."

Self Preservation Mode Data Table - 3000 Series

| Mode | ON | OFF |
|-----------------|----|-----|
| Beverage/Drinks | 10 | 45 |
| Market/Fresh | 10 | 45 |
| Root | 5 | 90 |
| Pantry | 10 | 45 |
| Deli | 10 | 45 |
| White Wine | 5 | 60 |
| Red Wine | 5 | 60 |
| Sparkling Wine | 10 | 60 |
| Polar | 55 | 5 |

Evaporator Thermistors

If an evaporator thermistor fails the unit will rely on a preset defrost timer during defrost cycles. The unit will otherwise operate normally. Refer to defrost section.

Ambient Thermistor

If the thermistor fails the unit will operate normally.

Thermistor Resistance Data

| Temp (F) | Temp (C) | Nominal Resistance (OHMS)* |
|-----------------|-----------------|-----------------------------------|
| -40 | -40 | 169157 |
| -31 | -35 | 121795 |
| -22 | -30 | 88766 |
| -13 | -25 | 65333 |
| -4 | -20 | 48614 |
| 5 | -15 | 36503 |
| 14 | -10 | 27681 |
| 23 | -5 | 21166 |
| 32 | 0 | 16330 |
| 41 | 5 | 12696 |
| 50 | 10 | 9951 |
| 59 | 15 | 7855 |
| 68 | 20 | 6246 |
| 77 | 25 | 5000 |
| 86 | 30 | 4029 |
| 95 | 35 | 3266 |
| 104 | 40 | 2665 |
| 113 | 45 | 2186 |
| 122 | 50 | 1803 |
| 131 | 55 | 1495 |
| 140 | 60 | 1247 |
| 149 | 65 | 1044 |
| 158 | 70 | 879 |
| 167 | 75 | 743 |
| 176 | 80 | 631 |

* (+/-5%)

Defrost

The models below have automatic or frost free design and do not require manual defrosting under normal conditions.

| Defrost Settings | | | | |
|-----------------------------------|------------------------------------|--|--------------------------------------|---------------------------------|
| Base Model | Variant(s) | Compressor Run Time Between Defrost (Hours) | Duration in Minutes (Maximum) | Stop Temperature °F (°C) |
| 1224 | RF | 12 | 45 | 15 (-9) |
| 1215/1224/2218/2245/ 2224/2260 | WC, ZWC | 12 | 45 | 45 (7) |
| 1215/1224/2218/2245/ 2224/2260 | R, RSOD, RDC, BEV, DC, DWR, RGL | 12 | 45 | 42 (6) |
| CO29 | F | 12 | 18 | n/a |
| CO1224 | F | 12 | 18 | 45 (7) |
| 1224FZR | Freezer Mode | 6 | 45 | 42(6) |
| 1224FZR | Refrigerator Mode | 12 | 45 | 42(6) |

The defrost settings for 3000 series models are determined by zone.

| Defrost Settings by Zone (3000 Series) | | | | |
|---|--|--------------------------------------|--------------------------------------|---------------------------------|
| Zones | Compressor Run Time Between Defrost (Hours) | Duration in Minutes (Minimum) | Duration in Minutes (Maximum) | Stop Temperature °F (°C) |
| Beverage/Drinks | 12 | 5 | 60 | 42 (6) |
| Market/Fresh | 12 | 5 | 60 | 42 (6) |
| Root/Root Cellar | 12 | 5 | 60 | 45 (7) |
| Pantry | 12 | 5 | 60 | 42 (6) |
| White Wine | 12 | 5 | 60 | 45 (7) |
| Red Wine | 12 | 5 | 60 | 45 (7) |
| Sparkling Wine | 12 | 5 | 60 | 45 (7) |
| Polar | 6 | 5 | 20 | 42 (6) |
| Deli | 12 | 5 | 60 | 42 (6) |

Remove Fan and Cover

CONVECTION COOLING

This unit is equipped with an advanced convection cooling system. Convection cooling stabilizes cabinet temperature, cools product faster and increases energy efficiency.

Evaporator Fan

The evaporator fan is responsible for circulating warm air from the refrigeration zone, past the evaporator and back into the refrigerated zone.

The evaporator fan is factory set to have a 1 minute delay at the beginning of a cooling cycle. This delay gives the evaporator time to cool properly before warm air is passed over it. The fan will continue to run for an additional 2 minutes at the end of a cooling cycle.

Evaporator fan operation is also determined by door switch state. If the door switch circuit opens, the fan will stop. When the door switch circuit is closed the fan will either continue running with the cooling cycle, or if not currently cooling, the fan will run for 1 minute to circulate air and clear any condensation that may have appeared on glass doors and shelves.

Note: If the unit is set to sabbath mode, the evaporator fan will no longer respond to the state of the door switch.

In order to operate efficiently, the evaporator fan blade and vents should be unobstructed and free of any dust buildup.

Evaporator Fan Replacement

Should the evaporator fan need to be replaced follow the steps below.

1. Remove any product from the unit.
2. Uninstall unit.
3. Disconnect power to the unit.

4. Remove back panel from unit.
5. Disconnect fan electrical connection
6. Remove insulating foam from refrigerant line pass-through hole as needed to gain clearance for fan plug.
7. Remove the drawer from the zone with defective fan.
8. Remove thermistor cover.
9. Remove two evaporator cover screws from top of evaporator cover.

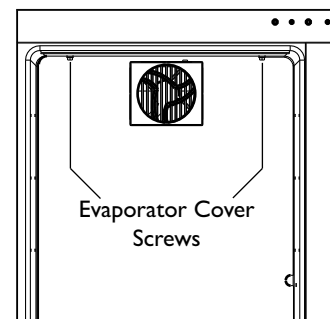

10. Grasp evaporator fan cover and gently pull away from the rear of the unit.
11. While pulling the evaporator cover clear of the unit, it may be necessary to use your free hand to manipulate the fan plug end through the pass-through hole.

12. Remove the 4 screws mounting the fan shroud to the evaporator plate.

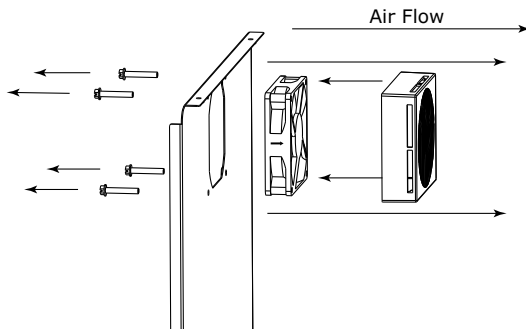

13. Remove and replace fan. Take special care to properly route fan wire.

NOTICE

Fan must be oriented to pull air in through lower evaporator plate vents and push air out at fan mounting location.

14. Installation is the reverse of removal.

15. Use sealant gum to seal any holes in the rear of the unit before replacing the rear cover.

16. Reinstall the unit taking care to level, center and secure as you found it.